

# RADIO — ELECTRONICS

K

HUGO GERNSBACH, Editor

formerly

**RADIO  
CRAFT**



**UNUSUAL TECHNIQUES  
IN SOUND RECORDING  
SEE AUDIO SECTION**

**MAY**

1950

**30¢**

U. S. and  
CANADA

**LATEST IN RADIO — ELECTRONICS — TELEVISION**

[www.americanradiohistory.com](http://www.americanradiohistory.com)



*New*

# Mallory Plascap\*

... Made with Amazing Mallocene\*!

## World's First Completely Engineered Plastic Tubular Capacitor

Here's the plastic tubular that's years ahead of its time . . . made possible *now* by Mallocene, amazing Mallory plastic development that gives you *four exclusive* performance firsts, leaves ordinary plastic tubulars far behind!

Gone is the old bugaboo of "call-backs" due to construction weaknesses beyond your control. For the Mallory Plascap is dependable. No oil leakage, no unsoldered leads, no off-center or deformed cartridges, no messy outside wax coating, no insulation problems. The Mallory Plascap makes your service job easier! See your Mallory Distributor.

### The Secret of Mallocene . . .

There is only *one* logical way to build a molded type plastic tubular capacitor . . . with a plastic that sticks to the metal leads! But with ordinary construction methods, this has been impossible, for such a plastic would stick to the metal mold!

Here's the secret of the Mallory Plascap. First, an extremely tough plastic shell is molded. The cartridge is carefully centered within this shell. Then, the cartridge is surrounded with Mallocene. When Mallocene hardens, it actually becomes part of the outer plastic shell, and *sticks to the metal leads!* Thus, Mallocene provides a solid plastic tubular capacitor with the *first* moisture-proof construction!



**TRISEAL CONSTRUCTION**—Sealed *three* ways —with moisture-free Mallotrol\* . . . tough outer plastic shell . . . exclusive Mallocene!



**DISTORTION-FREE WINDING** — No flattened cartridges due to molding pressures . . . no failures due to "shorts"!



**FASTITE LEADS**—Permanently fastened . . . sealed with Mallocene . . . unaffected by soldering-iron heat!



**TRU-CENTER CARTRIDGE**—Cartridge centered every time . . . uniform insulation guaranteed at all points!

Plus these **Top Features**: Operates at 85°C . . . No messy outside wax coating required . . . Great mechanical strength . . . Small in size . . . Light in weight . . . High dielectric strength . . . Lead to outside foil clearly identified . . . Handsome yellow case . . . Legible part-numbers and ratings.

P. R. MALLORY & CO. Inc.

# MALLORY

CAPACITORS . . . CONTROLS . . . VIBRATORS . . .  
 SWITCHES . . . RESISTORS . . . RECTIFIERS . . .  
 VIBRAPACK\* POWER SUPPLIES . . . FILTERS  
\*REG. U. S. PAT. OFF.

## APPROVED PRECISION PRODUCTS

P. R. MALLORY & CO., Inc., INDIANAPOLIS 6, INDIANA

\*Trade Mark

# LEARN RADIO-TELEVISION

BY PRACTICING AT HOME  
IN SPARE TIME WITH  
THESE AND OTHER KITS  
I SEND YOU

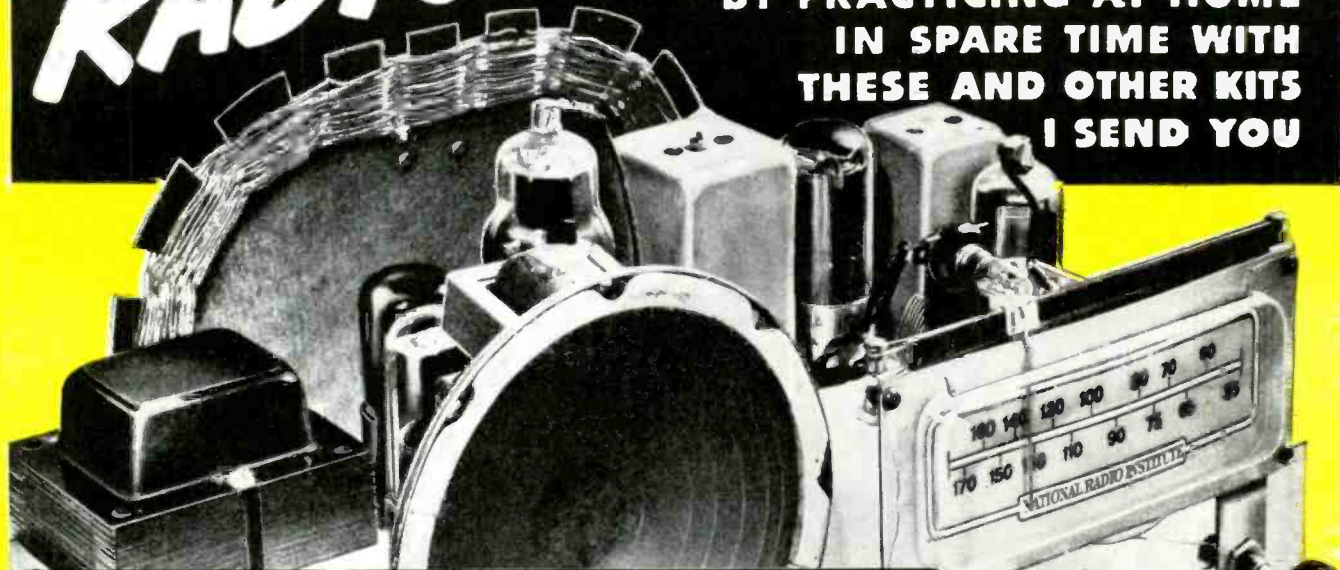

**I WILL TRAIN YOU AT HOME FOR  
GOOD PAY-SUCCESS  
A BRIGHT FUTURE**  
*in America's Fastest-Growing Industry*



J. E. SMITH, President  
National Radio Institute

### I TRAINED THESE MEN



"N. R. I. helped qualify me for position as Radio Mechanic with United Airlines.

Have my Radiotelephone 2nd Class License."—L. M. Hauger, San Bruno, Calif.



"Work only spare time at Radio and average about \$40 a month. Knew nothing about Radio before enrolling with N. R. I."—Samuel T. DeWald, St. Clair, Pa.



"I am operating a Radio Sales and Service business. With FM and Television in the offing, we have a very profitable future."—Albert Patrick, Tampa, Florida.

Want a good-pay job in the fast growing RADIO-TELEVISION Industry? Want a money-making Radio-Television shop of your own? Here's your opportunity. I've trained hundreds of men to be successful Technicians **MEN WITH NO PREVIOUS EXPERIENCE.** My tested and proved train-at-home method makes learning easy. You learn Radio-Television principles from illustrated lessons. You get practical experience building, experimenting with **MANY KITS OF PARTS** I send. All equipment yours to keep.

### MAKE EXTRA MONEY IN SPARE TIME

The day you enroll, I start sending **SPECIAL BOOKLETS** that show you how to make \$5, \$10 a week or more **EXTRA MONEY** fixing neighbors' Radios in spare time while learning. From here, it's a short step to your own shop or a good-pay Radio-Television servicing job. Or be a licensed Radio-Television Operator or Technician. The number of Radio Stations has nearly tripled in the last few years—and within three years, experts predict there will be 1000 Television stations on the air. Then add developments in FM, Two Way Radio, Police, Marine, Aviation, Microwave Relay Radio! Think what this means! New jobs, more jobs, good pay for qualified

men. The man who prepares now will reap rich rewards;

### MAIL COUPON FOR BOOKS FREE

Act now! Send for my **FREE DOUBLE OFFER.** Coupon entitles you to actual lesson, "GETTING ACQUAINTED WITH RECEIVER SERVICING." It shows you that learning at home is easy, practical. You also get my 64-page book, "HOW TO BE A SUCCESS IN RADIO-TELEVISION." It tells what my graduates are doing and earning, how quickly you can be on your way to good pay, success, a bright future. Send coupon in envelope or paste on penny postal. J. E. SMITH, President,

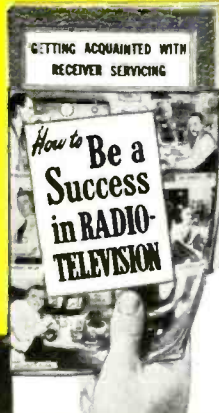
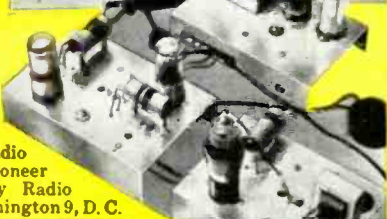

## Good for Both—FREE

**MR. J. E. SMITH, President, Dept. OEX  
National Radio Institute, Washington 9, D. C.**

Mail me Sample Lesson and 64-page Book about How to Win Success in Radio-Television—both **FREE.** (No Salesman will call. Please write plainly.)

Name..... Age.....  
Address.....  
City..... Zone..... State.....  
 Check if Veteran  Approved under G. I. Bill

**VETERANS** GET THIS TRAINING  
UNDER G. I. BILL

# RADIO — ELECTRONICS

formerly **RADIO-CRAFT**

MEMBER  
AUDIT BUREAU OF CIRCULATION

Incorporating  
**SHORT WAVE CRAFT\* TELEVISION NEWS\***  
**RADIO & TELEVISION**  
\*Trademark registered U. S. Patent Office

Hugo Gernsback, Editor-in-Chief

Fred Shunaman, Managing Editor  
Robert F. Scott, W2PWG, Technical Editor  
I. Queen, Editorial Associate

M. Harvey Gernsback, Editorial Director  
Angie Pascale, Production Manager  
Wm. Lyon McLaughlin, Tech. Illustration Director

Lee Robinson, General Manager  
John J. Lamson, Sales Manager

G. Aliquo, Circulation Manager  
Robert Fallath, Promotion Manager

## CONTENTS

MAY, 1950

<b>Editorial (Page 25)</b>	
The Future of Electronics.....by Hugo Gernsback	25
<b>Television (Page 26-39)</b>	
Review of TV Boosters.....	26
Spot-Wobble Improves Television.....by Major Ralph W. Hollows	29
Anything Can Happen in Television.....by Martin Clifford	30
Master Television Antenna Systems.....by Ira Kamen	32
A De Luxe Televiser.....by Charles Vaccaro	34
Voltage Multipliers in Television.....by C. W. Palmer	36
Television Dictionary.....by Ed Bukstein	38
KFEL Tests Site.....by Eugene A. Conklin	39
<b>Electronics (Page 40-41)</b>	
IRE "Accents the New".....	40
<b>Servicing—Test Instruments (Page 42-52)</b>	
Vacuum-Tube Grid Bias.....by H. B. Davis	42
A Signal Tracer and V.T.V.M. Combined.....by Harry Hatfield	44
Fundamentals of Radio Servicing, Part XV—Sound and Loudspeakers.....by John T. Frye	46
Compact Unit Tests Everything.....by Wesley Neelands	48
Capacitance Measurement with Signal Generator.....by Raojibbai J. Patel	49
Servicing Vibrator Power Supplies.....by John B. Ledbetter	50
Curing Modulation Hum.....by Ludwig Furth	52
<b>Audio (Page 54-69)</b>	
Intermodulation Distortion.....by Carl N. Shipman	54
Unusual Techniques in Sound Recording (Cover Story).....by Richard H. Dorf	60
Recording for Profit.....by Frank E. Fleming	64
<b>Construction (Page 72-77)</b>	
A High Performance Short-Wave Midget.....by Homer L. Davidson	72
Tuned Tone Control.....by P. Hemardinquer	77
<b>Amateur (Pages 78-83)</b>	
A Beam Antenna to Match 52-ohm Coax.....by Louis H. Hippe, W6APQ	78
<b>Broadcasting and Communications (Pages 84-88)</b>	
Frequency Control Unit for Citizens Band Tests.....by I. Queen	84
<b>New Design (Pages 98-99)</b>	
Hi-Volt Electrostatic Generators.....	98
Ultrasonic Soldering.....	99
<b>Departments</b>	
The Radio Month.....	8
Radio Business.....	10
Try This One.....	89
New Devices.....	91
New Patents.....	94
Radio-Electronic Circuits.....	96
Miscellany.....	100
Question Box.....	104
Technotes.....	106
Communications.....	108
Book Reviews.....	111

**ON THE COVER:** The new Fairchild Tape recorder beside one of the standard record cutters in the master recording room of Reeves Sound Laboratories. Posed by Bobbie Shaw for a Kodachrome by Avery Slack.

**RADIO-ELECTRONICS, May, 1950, Volume XXI, No. 8.** Published monthly. Publication Office: Erie Ave. E to G Streets, Philadelphia 32, Pa. Entered as second class matter September 27, 1948, at the post office at Philadelphia, Pa., under the Act of March 3, 1879. **SUBSCRIPTION RATES:** In U. S. and Canada, in U. S. possessions, Mexico, South and Central American countries, \$3.50; \$6.00 for two years; \$8.00 for three years; single copies 30c. All other foreign countries \$4.00 a year, \$8.00 for two years, \$11.00 for three years. Allow one month for change of address. When ordering a change please furnish an address stencil impression from a recent wrapper. **RADIO-CRAFT PUBLICATIONS, INC.** Hugo Gernsback, Pres.; M. Harvey Gernsback, Vice-Pres.; G. Aliquo, Sec'y. Contents copyright, 1950, by Radcraft Publications, Inc. Text and illustrations must not be reproduced without permission of copyright owners. **EDITORIAL and ADVERTISING OFFICES, 25 West Broadway, New York 7, N. Y.** Tel. Rector 2-9690. **BRANCH ADVERTISING OFFICES:** Chicago: 308 W. Washington Street. Telephone Randolph 6-7363. Los Angeles: Ralph W. Harker, 1127 Wilshire Blvd., Tel. MA 6-1271. San Francisco: Ralph W. Harker, 582 Market St., Tel. GARfield 1-2481. **FOREIGN AGENTS:** Great Britain: Atlas Publishing and Distributing Co., Ltd., London E.C.4. Australia: McGill's Agency, Melbourne. France: Brentano's, Paris 2e. Holland: Trilectron, Heemstede. Greece: International Book & News Agency, Athens. So. Africa: Central News Agency, Ltd., Johannesburg; Capetown; Durban. Natal. Universal Book Agency, Johannesburg. Middle East: Sleimatzy Middle East Agency, Jerusalem. India: Sushil Gupta (Distributors) Co., Calcutta. Broadway News Centre, Dadar, Bombay #14. K. L. Kannappa Mudaliar, Madras 2. Pakistan: Paradise Book Stall, Karachi 3. **POSTMASTER:** If undeliverable send form 3578 to: RADIO-ELECTRONICS, 25 West Broadway, New York 7, N. Y.

# American Beauty

## ELECTRIC SOLDERING IRONS

are sturdily built for the hard usage of industrial service. Have plug type tips and are constructed on the unit system with each vital part, such as heating element, easily removable and replaceable. In 5 sizes, from 50 watts to 550 watts.

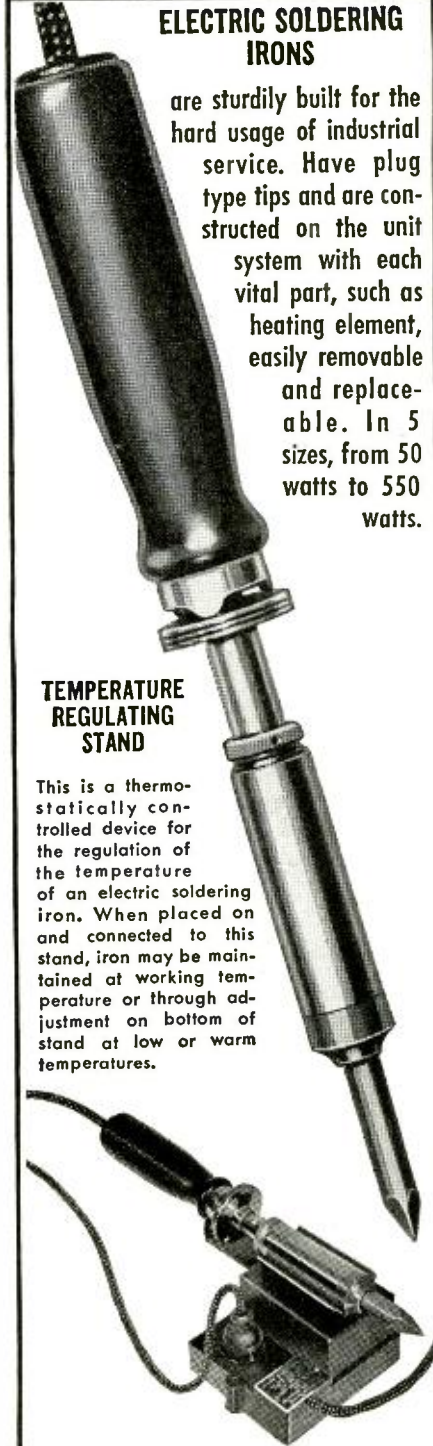

### TEMPERATURE REGULATING STAND

This is a thermostatically controlled device for the regulation of the temperature of an electric soldering iron. When placed on and connected to this stand, iron may be maintained at working temperature or through adjustment on bottom of stand at low or warm temperatures.

For descriptive literature write

**AMERICAN ELECTRICAL HEATER COMPANY**  
DETROIT 2, MICH., U. S. A.

RADIO-ELECTRONICS for



Get Into

# TELEVISION, RADIO ELECTRONICS

## Master ALL Phases

**Get Complete Training. You Receive and Keep All Tubes, Equipment, Parts and Lessons. No Extra Charges.**

**GOOD PAY  
and Unlimited Opportunities  
in JOBS LIKE THESE:**

Business of Your Own  
Radio Manufacturing, Sales, Service  
Broadcasting, Telecasting  
Television Manufacturing, Sales, Service  
Laboratories: Installation, Maintenance of Electronic Equipment, Electrolysis, Call Systems  
Garages: Auto Radio Sales, Service  
Sound Systems and Telephone Companies; Oil Well and Drilling Companies; Engineering Firms  
Theatre Sound Systems, Police Radio

And scores of other good jobs  
in many related fields

**YOU CONDUCT MANY  
EXPERIMENTS LIKE THESE!**

Checking action of condensers  
Experiments with AF and RF amplifiers  
Experiments with resonance  
Producing beat frequencies  
Calibrating oscillators  
Experiments with diode, grid-bias, grid-leak and infinite impedance detectors  
Practical experience in receiver trouble shooting  
Application of visual tester in checking parts and circuits  
Experiments with audio oscillators  
Advanced trouble-shooting  
... and many, many others

### Complete Training by Practical Resident Trade School, Est. 1905

The same highly trained faculty, instruction materials and methods used here in our large, modern resident school, are adapted to your training in your own home. Shop Method Home Training has been proved by hundreds of successful graduates.

**Both Resident and Home Study Courses Offered**

### YOU LEARN BY DOING

You receive special laboratory experiment lessons to show you how to build with your own hands various experimental units such as those shown at left, and how to conduct many tests.



**YOU RECEIVE THIS  
PROFESSIONAL MULTITESTER  
YOU BUILD ALL THESE AND  
MANY OTHER UNITS WITH  
PARTS WE SEND YOU!**



Signal Generator



Audio Oscillator



T.R.F. Receiver



You Build This Superheterodyne

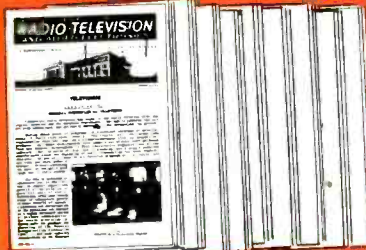

**You Receive a Special Series of Modern Lessons in TELEVISION, all a part of your course; you master all phases.**

You will find all lessons easy to understand because they are illustrated throughout with clear diagrams and step-by-step examples that you work out yourself. Every piece of the equipment and complete lesson material we send you is yours to keep and enjoy, including the multitester, experimental equipment, all parts of the Superheterodyne, tube manual, radio dictionary, and complete, modern Television texts. All parts are standard equipment.

### Shop Method Home Training . . . Earn While You Learn

With our practical resident Shop Method Home Training, you study in your spare time. You receive Spare Time Work Lessons, which show you how to earn while you learn. Service neighbors' radios and TV receivers, appliances, etc., for extra money and experience. Many National students pay all or part of their training with spare time earnings!

### DON'T DELAY! The Radio-Television Industry needs trained men NOW!

**APPROVED  
FOR  
VETERANS!**  
Check coupon below!

For quick action, mail coupon today and we'll rush you full information.

**Free!**

**NEW, ILLUSTRATED OPPORTUNITY BOOK AND SAMPLE LESSON SHOW YOU HOW WE TRAIN YOU . . . SEND FOR THEM TODAY! NO COST. NO OBLIGATION.**



### NATIONAL SCHOOLS

LOS ANGELES 37, CALIF. • EST. 1905

**FIND OUT NOW . . . MAIL COUPON TODAY**

National Schools, Dept. RE-5  
4000 South Figueroa Street  
Los Angeles 37, California

Mail in envelope or paste on penny postal.

Send me your FREE book "Your Future in Radio" and the sample lesson of your course. I understand no salesman will call on me.

NAME \_\_\_\_\_ AGE \_\_\_\_\_

ADDRESS \_\_\_\_\_

CITY \_\_\_\_\_ ZONE \_\_\_\_\_ STATE \_\_\_\_\_

Check here if Veteran of World War II

# Get more from your test equipment with

## RCA ACCESSORIES

### NEW RCA High-Voltage Probes—WG-289, WG-290

Extend dc voltage range of your instrument to 50 kv.



Only \$9.95

Complete with resistor. Suggested User Price.

The last word in high-voltage probes for measuring the voltage of TV power supplies and other high-voltage sources. Has six safety features, including anti-corona probe tip, completely insulated grip, and separate ground lead. Multiplier resistors available to adapt probes for practically all popular volt-ohm-meters. Provides high input resistance for accurate voltage readings without loading circuit. The WG-289 and WG-290 Probes are identical except for their connectors. The WG-289 has microphone-type connector; WG-290 has phone-tip connectors.

### NOW... the RCA TV Isotap WP-25A—A combination Isolation-Autotransformer for Television Servicing

Only \$16.50

Suggested User Price.

The answer to safe, accurate and speedy servicing of TV receivers... the RCA WP-25A TV Isotap provides *normal line voltage* for testing sets against manufacturer's rated specifications... *high line voltage* to test mittents and faulty components... *low line voltage* to test receivers under conditions similar to those found in some customers' homes... *line isolation* to prevent shorts, shocks, and damage to test equipment... *line matching*, from 105 to 130 volts, in 5-volt steps... *500 volt-amperes continuous output* from autotransformer winding; or 275 volt-ampere load from isolated secondary winding.



### RCA WG-263 CRYSTAL PROBE

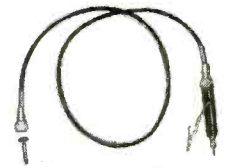

Converts VoltOhmyst\* Meters 163, 165, 165-A, 195, 195-A, WV-65A, WV-75A, and WV-95A into VHF voltmeters for use up to 100 Mc; also used with Chanalyst\* Analyzers Types 162, 162-A, 162-B, 162-C and 170-A. Can be used for relative readings to 175 Mc. Price: \$8.95.

\*Trade Mark, Reg. U. S. Pat. Off.

### RCA WG-275 DIODE PROBE



Designed to operate with RCA Volt-Ohmyst\* Electronic Meters WV-75A or WV-95A, for reading rms or peak-to-peak voltages at frequencies from 30 cycles to 250 Mc. The probe fits coaxial "T" connectors, and permits direct measurement of voltages in coaxial lines. Price: \$30.00.

\*Trade Mark, Reg. U. S. Pat. Off.

### RCA WG-265 MINIATURE TESTPOINT ADAPTER



Makes your troubleshooting faster, easier, safer by making tube-base connections accessible on the tube side of the chassis. Pins on one end of the adapter fit a 7-pin miniature socket, and socket facilities on the opposite end accommodate all types of 7-pin miniature tubes. Tabs project for easy probe contact. Price \$1.50.

### RCA ISOTAP WP-24A FOR RADIO SERVICING



Eliminates shock hazard between ac/dc chassis and ground, speeds detection of receiver faults with high-low line tests, and facilitates testing at 117-volt design-center value. Has six-position primary switch and three secondary receptacles. Price: \$8.95.

### RCA WS-18A RACK-ADAPTER PANEL



For mounting any of the matched RCA Test Instruments in standard 19-inch relay racks. Dimensions, 10½" high, 19" wide, ¼" thick. Price: \$9.50.

AVAILABLE FROM YOUR RCA TEST EQUIPMENT DISTRIBUTOR



**RADIO CORPORATION of AMERICA**  
TEST EQUIPMENT

HARRISON, N. J.

RADIO-ELECTRONICS for

# TV Exec Cites Need for More Skill in TV Servicemen

**Service Manager for Chicago Firm  
Warns "Old-Timers" that  
Youngsters are Better Prepared**

AT a recent meeting of the Philadelphia Radio Servicemen's Association, Tim Alexander, service manager of Motorola, Inc., Chicago, and chairman of the Radio Manufacturers' Association Service Committee, as quoted in *Radio & Television Weekly*, warned the old-timers among the radio servicemen that the "youngsters" coming into the business, fresh out of colleges and technical schools, would be taking their jobs away from them unless they take the necessary steps to make themselves as "competent as their new competition."

He pointed out that the "screw-driver and plier" serviceman has no permanent place in television, and that adequate test equipment and knowledge of its use are as important to the television technician as the X-ray machine is to the surgeon.

Mr. Alexander said, "If you are a mediocre television man who can repair a set only by slow, plodding, tenacious work—watch out. Pretty soon one of those 'youngsters' will open a store across the street from you. By virtue of his better training and greater skill, he will be able to do the job in one-quarter of the time. He will be paid twice as much per hour as you get, but the customer will still get off at half-price." He advised the men to go to school again for latest methods and servicing information.

\* \* \*

CREI offers just the specialized training you need. It's a streamlined course — fast, accurate, and complete—for men in the top third of the field. It gives practical answers to the technical problems you run into while servicing today's intricate TV and FM equipment. It is kept up-to-date through constant checking with CREI's affiliate, one of Washington's largest retailers of TV sets and home appliances. Maintenance problems encountered by this retailer's TV technicians are used as a practical lab to test the precision of CREI training. CREI, an accredited technical institute founded in 1927, invites your investigation. CREI graduates to-



*Adequate test equipment and knowledge of its use are as important to TV technicians as X-ray machines are to surgeons.*

day fill important radio-TV posts throughout the industry. During the war CREI trained thousands of technicians for the Army, Navy and Coast Guard. Special CREI technical texts were used in the Navy's own training program. Leading industrial firms—RCA Victor, United Air Lines, TWA, Pan American Airways—to name only a few—have CREI group training programs now in operation.

Start your training now and apply your knowledge immediately. If you are in an area where TV stations are already in operation, you *know* of the great amount of profitable work that exists. If your area does not yet have TV, remember this: By 1954, according to most conservative estimates, every important community in the country will have TV!

Write today for complete FREE information; the cost of the course is popular, the terms easy.

**The Three Basic CREI Courses:** Television and FM Servicing (streamlined course for men in "top third" of field); Practical Radio Engineering (fundamental course in all phases of radio-electronics); Practical Television Engineering (specialized training for professional radiomen).

*Also available as Residence School Courses.*

**Veterans:** CREI Training Available Under G.I. Bill. For most veterans July 25, 1951, is the deadline. Act now!

**Free Sample Lesson.** See for yourself how CREI training can help you. "Television & FM Trouble Shooting" is yours upon request. Mail the coupon below and receive this interesting lesson devoted to live, "dollar-and-cents" practical practice based on day-to-day servicing problems.

**CAPITOL RADIO ENGINEERING INSTITUTE**  
Dept. 145B, 16th & Park Rd., N. W., Washington 10, D. C.

Gentlemen: Send me FREE SAMPLE LESSON and complete details of the TV and FM Servicing home study course. Also send brochure that explains the CREI self-improvement program and gives complete details and outline of course. I am attaching a brief resume of my experience, education and present position.

Check the Field of Greatest Interest:

<input type="checkbox"/> TV, FM & Advanced AM Servicing	<input type="checkbox"/> Aeronautical Radio Engineering
<input type="checkbox"/> Practical Television Engineering	<input type="checkbox"/> Broadcast Radio Engineering (AM, FM, TV)
<input type="checkbox"/> Practical Radio Engineering	<input type="checkbox"/> Radio-Electronics in Industry

I AM ENTITLED TO TRAINING UNDER G.I. BILL.

NAME \_\_\_\_\_ AGE \_\_\_\_\_

ADDRESS \_\_\_\_\_

CITY \_\_\_\_\_ ZONE \_\_\_\_\_ STATE \_\_\_\_\_

SEND DETAILS ON RESIDENCE SCHOOL.

**ELECTRONIC HOTFOOT** is given to pigeons who come to roost in the columns of the State Education Building in Albany, New York. The entrance to the building was once a favorite bombing range until the electronic eliminator was installed.

The eliminator consists of a series of porcelain terminals strung on wires and placed on ledges and overhanging cornices. An r.f. pulse is sent through the wires which sets up a magnetic field around the terminals. When a bird enters the field, he gets a jolt which is harmless but nevertheless very uncomfortable.

**SIGNAL CORPS** achievements will be displayed on May 13 at Ft. Monmouth, N. J., in an all-day program for delegates to the national convention of the Armed Forces Communications Association to be held at N. Y. C. on May 12. Leaders in the communications and electronics fields and high-ranking officers from all branches of the armed services will be present.

The program will feature elaborate displays from the Signal Corps Engineering Laboratories, the Armed Services Electro-Standards Agency, and the Signal School of Ft. Monmouth; parachute drops by the 82nd Airborne Division; wire laying demonstrations by helicopter and bazooka; and a combat communication problem in which the airborne troops will figure if the weather is good.

**CONDUCTIVE GLASS** is a recent development of the Corning Glass Works. The glass has a transparent skin of a metallic oxide about 16 millionths of an inch thick which conducts electricity but has enough resistance to heat the glass up to 660° F.

In the first field tests heaters made of flat panels of the new glass were used to keep baby chicks warm in brooders, to dry textile yarns, and to dry lacquer on plastic playing cards. A coffee percolator of electric glass is being developed. The coffee maker will rest on a plastic base, and electrodes will carry current to the electric skin on the bottom of the pot.

The new material might also be used as wall panels in a bath room or to keep ice from forming on windshields. The glass can produce a wide range of temperatures, depending on the resistance of the film and the voltage used.

**SOLAR ENERGY** may be the answer to the coal crises which come dangerously close to upsetting our economy. Dr. Dean Burk of the National Institute of Health told the finalists of the ninth annual Science Talent Search at a meeting in Washington, D. C., that vast quantities of hydrogen, a highly useful fuel, could be made available if man could master photosynthesis, the process by which plants use solar energy. If this could be done, man could merely direct the sun to decompose water to oxygen and hydrogen.

**INCOME TAX** returns are being checked by electronic robots this year in New York and four other cities. The Bureau of Internal Revenue has installed fifteen electronic brains, each of which can check all of the involved computations of a 1040 tax return at the rate of 800 returns a minute.

When a tax return is processed, all of the pertinent data is abstracted on an electric card punching machine. The cards are then fed to the robot which traces all of the taxpayers calculations in a seventieth of a second. It finds each mistake and shows where it is. If a refund is due, it is noted; and if an assessment is needed, the machine takes care of that, too. If the taxpayer comes within a dollar of being balanced with the government, the machine calls it quits.

These machines and other work-speeding devices are being used by the bureau to get refunds back to the taxpayer before the interest accumulates.

**ALUMINUM MIRROR** is used to reflect TV signals in a studio-transmitter link of WNBC-TV in Binghamton, N. Y. Such links are usually provided by special land lines or by a line-of-sight microwave beam. In this case, the transmitter building was on the far slope of a wooded hill about 3½ miles from the studio and a land line up the hill would have been very expensive.

Although the transmitter building has no line-of-sight path to any of the tall buildings in the city, it did have a 384-ft. antenna tower which rose well above the crest of the hill. Engineers placed a 7-foot square sheet of aluminum about halfway up the tower to reflect a microwave beam from the top of the local telephone building to a dish antenna on the roof of the transmitter building.

This is believed to be the first case in which a reflector such as this is used in a television studio-transmitter link, and it required careful planning. Weather men were consulted to find out how much the tower could be expected to sway in the wind. With the mirror halfway up the tower, transmission is not disturbed by any wind-storm. A swath had to be cleared through the woods on the hill to get a line-of-sight path from the equipment in the city to the mirror on the antenna tower.

**GUIDED MISSILES** may be guided to their targets by robot "saboteurs" planted in enemy cities. This was hinted in a *Glossary of Guided Missile Terms* published last month by the Defense Department's Research and Development Board. The reference was to a "semiautonomous homing guidance" by which the guided bomb homes on a target "illuminated from a source other than the missile."

In practice the missile would follow a radio beam either located in the enemy city, smuggled there by secret agents, or by a beam pointed at the city from outside it and reflected from it on an angle.

RADIO-ELECTRONICS for



See Us  
at the  
**MAY  
SHOW**

and we'll explain how to  
make TV SIGNALS strong  
enough to do MOST ANYTHING

IN ADDITION to our leading role in the production of microphones, pickups, pickup cartridges and related equipment — making weak TV signals strong has become a big business with us. You've heard of the Astatic Model AT-1 Television Booster, of course — the one with such unequalled quality that it holds top sales despite top price. Well, we want to give you the whole story on the AT-1 at the Show, plus a good look inside a real SURPRISE PACKAGE! We will have a brand new model booster to show you . . . not a modified version of our present booster but one that's entirely different, from the inside out!

The newest Astatic cartridges and pickups will be there for your inspection. Never before have we had so much that's new to warrant your interest and enthusiasm!

We're anxious to tell you all you want to know about Astatic products . . . and we're anxious to see you and shake your hand. You'll be more than welcome.





**FIELD STATION** to make continuous measurements of radio waves reflected from the upper atmosphere has been established at Fort Belvoir, Virginia, by the National Bureau of Standards. The Belvoir Field Station is one of a system of fourteen stations operating under the supervision of the Bureau's Central Radio Propagation Laboratory and is part of a world-wide network of over 50 radio observatories.



Some of the equipment at Fort Belvoir.

The station has four separate buildings designed for ionospheric and geophysical measurements. Equipment includes the latest in field intensity recorders, ionospheric recorders, and visually-recording magnetographs. Data gathered at the new station will be used to make predictions three months in advance of the best frequencies for short wave radio communication as well as warnings of sudden radio disturbances.

The Belvoir Field Station serves as a training center in the techniques of ionospheric and field intensity measurements. It is also a testing ground for new measuring equipment and procedures that are proposed for use at all of the Bureau's field stations.

**INTERFERENCE** from local oscillators in television receivers is a very serious problem according to Chairman Wayne Coy of the Federal Communications Commission. (See January, 1950 issue, page 36.) The FCC hopes to get away from this problem by opening up the u.h.f. range to television broadcasting.

Mr. Coy told a House subcommittee that the oscillators of some television receivers put out enough power to put out of commission all the receivers within a 1-mile radius. He said that the Boston-Providence area is bothered with this trouble and that there are 32,000 receivers in this area which cannot get either channel 11 broadcasts from Providence or channel 7 broadcasts from Boston because of it.

MAY, 1950

**DEATH RAYS** that will kill fruit flies and other insects which contaminate food are being used in experiments by the U. S. Bureau of Entomology and Plant Quarantine.

The rays are produced by a 2½-million-volt machine which shoots electrons at the insects in blasts that last for 1 microsecond. At a range of 12 inches, the electrons kill insects over a 14-inch square.

The machine is called a capacitron and was first used for sterilizing and preserving foods. The experiments in killing insects were begun at the request of agricultural experts in Hawaii who were worried about fruit flies in food exported from the islands.

So far, the rays have killed mosquitoes, fruit flies, carpet beetles, flour beetles, and other kinds of insects. They also work on insects in the egg or larva stage.

**AIR SAFETY** equipment is being purchased by the Civil Aeronautics Administration in a 4-million dollar order, the largest ever made by the CAA.

The order calls for 450 "distance measuring equipment" ground stations for use with a nation-wide network of omni-directional radio ranges. The new D.M.E. transmitters, as the units are called, are part of an air navigation system developed by the Radio Technical Commission for Aeronautics and approved by Congress for installation. It will require about 15 years to complete the system.

Aircraft now can follow direct courses between the CAA's omniranges, or they can follow courses parallel to the airways by taking periodic cross-bearings on more than one such station. The D.M.E. units will be installed on top of existing omnirange stations and will give the airmen an exact mileage "fix" on the course they are following. This will eliminate the need for estimating how far they have travelled between ranges.

**FRINGE COMMUNITIES** in Wisconsin are investigating the dangers of large private television antenna towers in order to enact control ordinances. Residents in cities as far as 100 miles from Milwaukee have erected towers upwards of 60 feet high in an effort to receive programs from Milwaukee and even Chicago.

**TEN DEVELOPMENTS** in radio which were the most outstanding during the first half of the twentieth century were listed last month by Dr. C. B. Jolliffe, executive vice-president in charge of RCA Laboratories. They are:

1. Wireless communications;
2. The electron tube;
3. Radiotelephone communication;
4. Radio broadcasting;
5. All-electronic television;
6. Facsimile-type transmission;
7. Radio navigation aids;
8. Radar;
9. Remote radio control;
10. Microwave relays.

## 2 IMPORTANT NEW PHOTOFAC BOOKS

### "TELEVISION TUBE LOCATION GUIDE"



Gives Tube position and function in hundreds of important TV receiver models, made by 56 manufacturers.

### FIND THE TROUBLE AND REPLACE TUBES WITHOUT REMOVING CHASSIS

Nothing like it! The only book that shows the position and function of tubes in hundreds of TV receivers. Often an operational check in the customer's home . . . looking at the picture tube and listening to the sound . . . can give you a clue to the trouble. Many times only a tube failure is responsible. TGL-1 makes trouble diagnosis and tube replacement quick and simple, in most cases *without removing the chassis!* Each model has its own clear, accurate diagram. Book fully indexed for quick reference. Over 200 pages, handy pocket size, 5½ x 8½". Get two copies . . . one for outside calls and one for your bench. Pays for itself on the first job!

ORDER TGL-1 Only . . . . . \$1.50



### "DIAL CORD STRINGING GUIDE"

**NEW!**  
SECOND VOLUME  
Covers models from 1947 to October 1949

Over 45,000 servicemen bought the first volume of this invaluable book! New second volume includes 511 different dial cord stringing diagrams used in almost 1000 receivers produced from 1947 to October, 1949 (all new data continuing from where the first volume left off). There's only *one right way* to string a dial cord . . . and here's the *only* book that shows you how. Saves time—saves effort. Handy pocket size. Order copies for your tool kit and work bench today.

ORDER DC-2 Only . . . . . \$1.00

### HOWARD W. SAMS & CO., INC.

Order from your Parts Jobber today, or write direct to HOWARD W. SAMS & CO., INC., 2201 East 46th Street, Indianapolis 5, Ind.

My (check) (money order) for \$ . . . . . enclosed. Send the following books:

- TGL-1 "TV Tube Location Guide" \$1.50  
 DC-2 "Dial Cord Stringing Guide" \$1.00

Name . . . . .

Address . . . . .

City . . . . . Zone . . . . . State . . . . .

the 1950

Remember...  
May is Market Month!



"The only all-industry sponsored Conference and Show in Electronics"

## PARTS DISTRIBUTORS CONFERENCE AND SHOW

MAY 22-25 1950 • STEVENS HOTEL • CHICAGO

The annual Parts Distributors Conference and Show will be held this year at the Stevens Hotel, Chicago from May 22-25. Approximately 175 manufacturers, merchandising their products through parts distributors, have either reserved booths in the Exhibition Hall or will show their products in display rooms throughout the hotel. Many of the manufacturers will have both booths and display rooms. The Show committee is sponsoring many innovations in this year's program, and

attendance in the Exhibition Hall will be restricted exclusively to distributors. All other members of the manufacturing industry will have access to display rooms in the hotel. From all indications, there is every reason to believe that the 1950 Conference and Show will be the most successful and best attended in history. Following is a list of exhibitors who have reserved space in either the Exhibition Hall or in display rooms at the Stevens for their displays.

### List of Exhibitors in THE 1950 PARTS DISTRIBUTORS CONFERENCE & SHOW

COMPANY	EXHIBITION HALL BOOTH	DISPLAY ROOM
Aerovox Corporation	404	
Aircraft Marine Products, Inc.	124	610
Alliance Mfg. Co.	222	
Alpha Wire Corp.	516	
Altec Lansing Corp.	302	
American Microphone Co.	503	
American Phenolic Corp.	614	550A-551A
American Radio Hardware Co., Inc.	109	
American Television & Radio Co.	420	
Amperite Company	110	
Anchor Radio Corp.	2	
Approved Electronic Instrument Corp.	10	
Astatic Corp.	317	
Atlas Sound Corp.	417	521A
Audio Devices, Inc.	611	602A
Barker & Williamson, Inc.	422	
Belden Manufacturing Co.	405	501A
Bell Sound Systems	514	524A-526A
David Bogen Co.	407	505A
British Industries	301	
Brush Development Co.	106	658-659
Bud Radio, Inc.	206	
Burgess Battery Co.	221	
Camburn, Inc.	129	
Carter Motor Co.	601	
Centralab Div.	509	
Chicago Transformer Division	606	656A-657A
Cinch Manufacturing Co.	413	
Claroostat Manufacturing Co.	320	
Cleveland Electronics, Inc.	204	542A
Columbia Wire & Supply Co.	619	
Condenser Products	418	
Consolidated Wire & Assoc. Companies	7	
Continental Carbon, Inc.	108	
Cornish Wire Co.	613	
Crescent Industries, Inc.	115	557
Crest Transformer Corp.	607	
J. W. Davis & Co.	103	
Drake Electric Works	518	637
Dumont Electric Co.	101	
Duotone Company	521	
Eckstein Radio & TV Co.		612
Electric Soldering Iron Co.	310	
Electronic Instrument Co.	202	601
Electronic Measurements Corp.	6	
Electro Products Labs.	219	
Electro-Voice, Inc.	127	604A-605A
Electrovox Co.	107	
Ellar Woodcraft Corp.	122	
Erie Resistor Corp.	415	
Espey Manufacturing Co.	406	
Freed Transformer Co.	118	
Gee-Lar Products Co.	5	
General Cement Mfg. Co.	114	502
General Electric Co.	608	539A
General Industries, Inc.	208	515A-517A
General Transformer Corp.	501	
Girard-Hopkins	511	
Guardian Electric Mfg. Co.	212	
Hallidson Co.	414	
Hallcrafters Co.	605	530A-532A

COMPANY	EXHIBITION HALL BOOTH	DISPLAY ROOM
Hammarlund Mfg. Co.	7	
Hardwick, Hindle, Inc.	519	
Hickok Electrical Instrument Co.	318	544A
Holl Audio Industries	203	547
House of Television, Inc.	14	
Illinois Condenser Co.	617	
Indiana Steel Products Co.	116	504A
Industrial Condenser Corp.	504	
Industrial Development Eng. Assocs.	27	
Insuline Corp. of America	616	556
International Resistance Co.	307	
Jackson Electrical Instrument Co.	520	
Jackson Industries	604	
J-B-T Instruments, Inc.	508	657
Jensen Industries, Inc.	517	
Jensen Manufacturing Co.	402	504-505
Jerrold Electronics Corp.	9	658A-659A
J. F. D. Mfg. Co., Inc.	120	516
E. F. Johnson Co.	133	
Kester Solder Co.	111	
La Pointe Plascomold Corp.	26	
Leach Relay Co.	113	
Lectrohm, Inc.	519	
Lenz Electric Mfg. Co.	314	
Littlefuse, Inc.	313	560A
P. R. Mallory & Co.	121	
Markel Electric Products	602	609A
Merit Transformer Co.	221	
James Millen Mfg. Co.	217	
M. A. Miller Mfg. Co.	211	
National Company, Inc.	306	
National Union Radio Corp.	117	521
Newcomb Audio Products Co.	119	
Nicholas Equipment Co.	8	
Oak Ridge Products	11	
Ohmite Manufacturing Co.	612	507A
Oxford Electric Corp.	515	
Park Metalware Co.	319	
Par-Metal Products Corp.	209	
Pentron Corp.	4	656A
Permoflux Corp.	603	533A-534A
Permo, Inc.	25	
Phalo Plastics Corp.	3	
Philmore Mfg. Co., Inc.	213	535A-536A
Phoenix Electronics, Inc.	618	549
Pickering & Co., Inc.	12	619
Potter & Brumfield	123	553A
Precision Apparatus Co.	303	522
Premax Products Division	135	
Presto Recording Corp.	207	613A
Pyramid Electric Co.	502	
Quam-Nichols Co.	510	501
Racon Electric Co.	130	553
Radeleo Manufacturing Co.	24	
Radiart Div.	421	523
Radio City Products Co.	416	556A
Radio Corporation of America	22	512-513
Radio Craftsmen, Inc.	522	619
Radio Merchandise Sales, Inc.	131	631A
Radion Corp.		654A-655A
Radio Receptor Co., Inc.	205	
Rauland-Borg Corporation	610	507-509
Raytheon Mfg. Co.	322	

Recoton Corp.	321	
Rek-O-Kut Co.		557A
John F. Rider Publisher, Inc.	505	500
Howard W. Sams & Co.	308	
Sangamo Electric Co.	218	561
Walter L. Schott Co.	214	
Hermon Hosmer Scott, Inc.	1	614A-615A
Sheldon Electric Co.	201	632
Shure Brothers, Inc.	512	519A-520A
McMurdo Silver Co.	21	
Simpson Electric Co.	411	607A
Mark Simpson Mfg. Co.	609	605-607
Herman H. Smith, Inc.	316	
Snyder Manufacturing Co.	125	
Sola Electric Co.	513	
Spirling Products Co.	225	612A
Sprague Products Co.	403	
Standard Coil Products Co.	13	
Standard Transformer Corp.	401	512A-513A
Stephens Manufacturing Co.		622A-623A
Supreme, Inc.	311	
Sylvania Electric Products	615	
Talk-A-Phone Co.	410	610A-611A
Technical Appliance Corp.	304	
Thordarson Electric Mfg. Div.	409	
Triad Transformer Mfg. Co.	408	
Tricraft Products Co.	216	
Trimm, Inc.	128	
Triplett Elec'l Instrument Co.	315	520
Tung-Sol Lamp Works	104	613
Turner Co.		509A
Ungar Electric Tool Co.	309	
Unimac Products Div.		533-534
United Transformer Co.	305	
University Loudspeakers, Inc.	506	660
Vaco Products Co.	507	
James Vibrapower Co.		611
V-M Corporation	23	528A
Waldom Electronics Co.	223	
Ward Leonard Electric Co.	220	
Ward Products Corp.	312	537A
Webster-Chicago Corp.	210	
Weller Manufacturing Co.	215	
Weston Elec'l Instrument Corp.	419	
Wilcox-Gay Corp.	102	600
Wincharger Corp.	126	
Workshop Associates	105	601A

### PUBLICATIONS

COMPANY	DISPLAY ROOM
RADIO-ELECTRONICS	602
Boland & Boyce, Inc.	635A
Bryan-Davis Publishing Co.	561A
Caldwell-Clements, Inc.	604
Cowan Publishing Corp.	618A-619A
Electronic Publishing Co.	603A
FM-TV Magazine	638A
Jobber News	537
Parts Jobber	630A
Radio & TV Journal	655
Radio & TV News	629
Radio & TV Weekly	614
United Catalog Publishers	603-609

The Association of Electronic Parts and Equipment Manufacturers, Chicago, in their February meeting, authorized its publicity committee, to prepare a program on brand names.

The publicity committee consists of HELEN STANLAND QUAM, of Quam-Nichols Co., Chicago, chairman; JEROME J. KAHN, Standard Transformer Corp., Chicago; and RALPH BRENGLE, Potter & Brumfield Co., Princeton, Indiana.

"The parts industry is spending millions of dollars on advertising schedules to acquaint the distributor and the consumer with its products and the only way it can protect that investment is to take effective steps against the substitution of unbranded, surplus, dumped, and distress merchandise," Mrs. Quam told the members.

"The eclipse of individual trade names would invite regimentation of the parts industry and ultimately reduce the manufacturer to the status of an anonymous supplier," she added.

RADIO-ELECTRONICS for

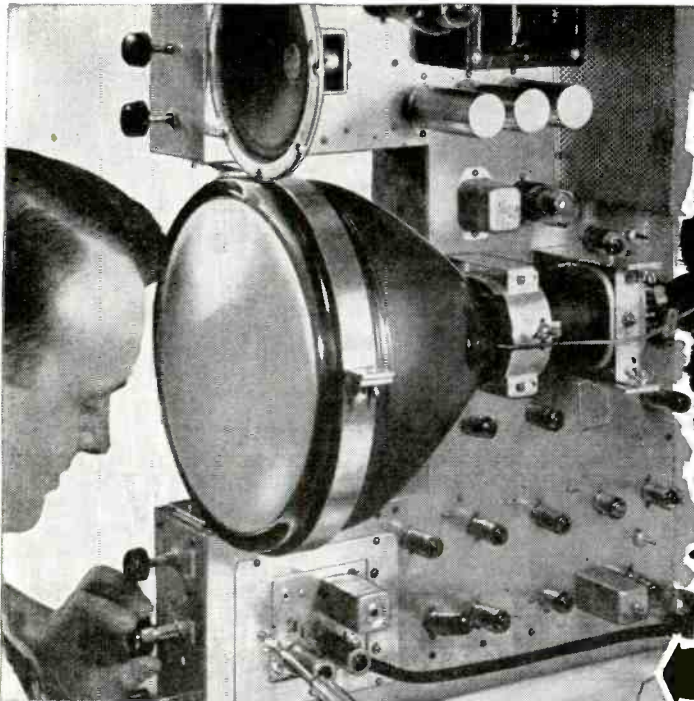

Only D.T.I.  
offers you the  
**"BIG 5"**  
**TELEVISION**  
RADIO-ELECTRONICS  
Laboratory Type  
**HOME TRAINING**

**Build and Keep 10, 12½ or 16 inch Picture Tube Quality TELEVISION RECEIVER as you prepare for a Profitable Future**

Here is everything you need to prepare you at home for FASCINATING WORK, GOOD MONEY and a THRILLING FUTURE in one of America's most promising fields.

This includes the opportunity to build and keep the top quality Television Receiver shown above—with choice of a 10, 12½ or 16 inch picture tube that gives big, bright, sharp, steady pictures. Get the complete facts. This is an optional feature — available when you complete your training described below. See how D.T.I.'s wonderfully practical "BIG 5" method meets industry's needs. No previous experience needed. Mail coupon today!

**16 Big Shipments of Parts — Plus Lessons**

Work over 300 electronic experiments and projects from 16 big shipments of parts. This includes building and keeping all test equipment and radio set shown at left side of page. Modern easy-to-read lessons with handy fold-out diagrams simplifies your entire training.

**You Also Use Home Movies**

D.T.I., alone, includes the modern, visual training aid . . . MOVIES to help you learn faster, easier at home. See electrons on the march and other fascinating "hidden action"—a remarkable home training advantage that speeds your progress.

**EMPLOYMENT SERVICE**

When you complete your training, our effective Employment Service helps you get started toward a real future in Television-Radio-Electronics.

**Modern Laboratories**

If you prefer, you can get All your preparation in our new, Chicago training laboratories . . .

6 Tube Radio Receiver  
one of the finest of its kind. Ample instructors . . . modern equipment. Write for details!

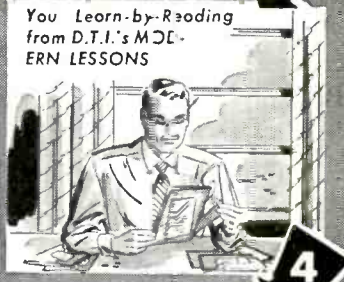
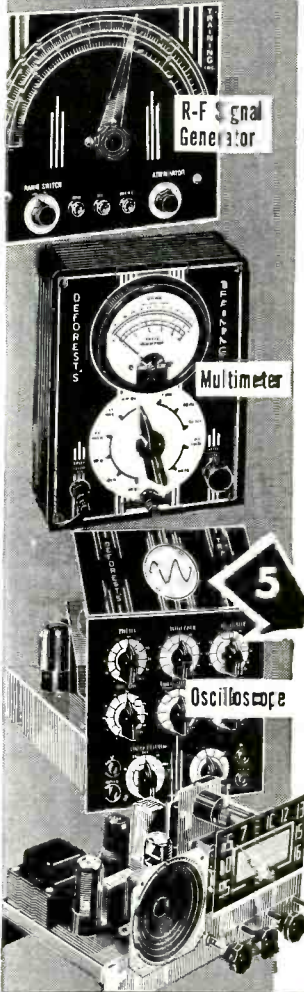

**MAIL THIS COUPON TODAY!**

**DeFOREST'S TRAINING, INC.**  
2533 North Ashland Avenue, Dept. EC-G-5  
Chicago 14, Illinois.

Without obligation, give me complete facts showing how I may make my start in Television-Radio-Electronics.

Name \_\_\_\_\_ Age \_\_\_\_\_  
Street \_\_\_\_\_ Apt. \_\_\_\_\_  
City \_\_\_\_\_ Zone \_\_\_\_\_ State \_\_\_\_\_

**DeFOREST'S TRAINING, INC.**  
Chicago 14, Illinois  
A DeVry Institution

"Leave it to Sylvania!"



# SYLVANIA ANNOUNCES...



"Another Sylvania advance!"

## Two Outstanding New

"That's great news for TV Service men!"



# TV Test Instruments!

Sylvania's early pioneering in radio testing devices naturally places this company in a position to step ahead in the field of television testing equipment.

So again Sylvania comes through! This time for service dealers everywhere, with a splendid new line of TV Test Equipment. Here are the first two instruments in this line. A new TV Marker Generator will be announced soon. Mail coupon for prices and latest specification sheets.



Type 400

### Sylvania TV Oscilloscope

Here's an entirely new high gain, wide band oscilloscope especially designed for television. Accurately displays any TV pulse, wave-shape or signal on a large 7-inch screen. Has excellent tilt, rise-time, and overshoot characteristics. Features include: 3-position frequency-compensated attenuator; vernier gain control; low internal hum level. Mail coupon for full details.

### Sylvania TV Sweep Signal Generator

This compact instrument is equipped with electronically controlled sweep circuits to eliminate the complexities inherent in mechanical type sweeps.

The smooth attenuator gives continuous control of the output from 300 microvolts to the maximum of .1 volt. Voltage-regulated power supply insures good frequency stability. Double shielded to prevent unwanted signal leakage.

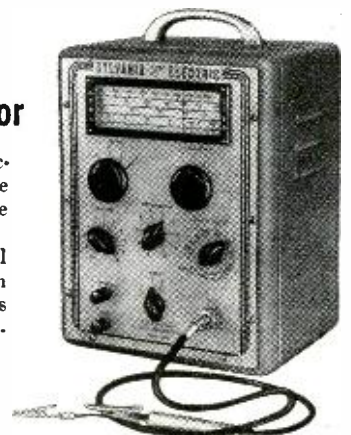

Type 500



RADIO TUBES; TELEVISION PICTURE TUBES; ELECTRONIC PRODUCTS; ELECTRONIC TEST EQUIPMENT; FLUORESCENT LAMPS, FIXTURES, SIGN TUBING, WIRING DEVICES; LIGHT BULBS; PHOTOLAMPS; TELEVISION SETS

# SYLVANIA ELECTRIC

Sylvania Electric Products Inc.  
 Advertising Dept. R-1005  
 Emporium, Pa.  
 Please send me full details about Sylvania's new TV Test Equipment.

Name \_\_\_\_\_  
 Street \_\_\_\_\_  
 City \_\_\_\_\_ Zone \_\_\_\_\_ State \_\_\_\_\_

RADIO-ELECTRONICS for

# CHANNEL MASTER'S

# Super-Fan!

• STRENGTH • RIGIDITY • SENSITIVITY

SUPERSEDES  
THE BM 312  
FAN FLECTOR  
SERIES



- LOWER PRICES
- SMALLER BOX
- SUPERIOR PREASSEMBLY

## HOWLPROOF BREAKPROOF

The Super-Fan series are the most sensitive broad band antennas, stack for stack, commercially available. Their 150 ohm impedance permits efficient low loss tie-in to all standard transmission lines. Safety engineered with solid aluminum inserts, and howl proof sealed ends, these antennas withstand ice loads and high winds silently and without breakage.

These models also feature *Swing-Lock-Action*, the patented preassembled feature of all Channel Master antennas. Just swing out elements and lock them in place — as easy as that.



A TELEVISION SET IS NO BETTER THAN ITS ANTENNA  
THERE IS NO BETTER ANTENNA THAN THE SUPER-FAN

## GAIN OF THE SUPER-FAN SERIES

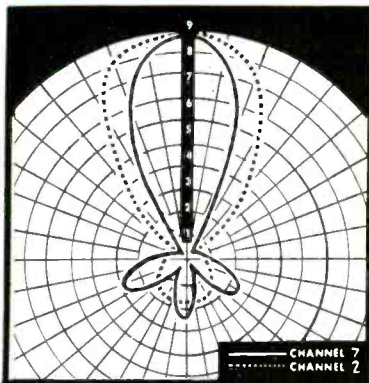

HORIZONTAL POLAR DIAGRAMS

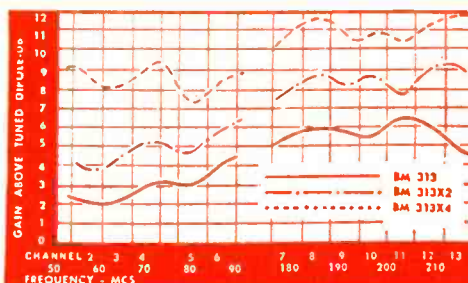

GAIN CURVES

CHANNEL	2	3	4	5	6	7	8	9	10	11	12	13
313	2.1	2.2	3.0	3.0	4.0	5.5	5.8	5.8	5.7	6.5	6.0	4.7
313X2	4.8	5.0	6.1	5.7	6.9	9.0	9.7	9.3	9.4	8.8	9.8	10.0
313X4	9.0	8.7	9.0	7.5	8.5	11.0	11.4	10.6	10.8	10.3	11.3	11.9

GAIN IN DB. ABOVE TUNED DIPOLE



FIRST IN PRE-ASSEMBLED ANTENNAS

ELLENVILLE, N. Y.

MAY, 1950

TO: CHANNEL MASTER CORP., ELLENVILLE, N. Y. E 5

Please send me:

Name of nearest Channel Master Distributor

Technical data and literature

YOUR NAME .....

COMPANY NAME .....

ADDRESS .....

CITY..... STATE .....

**NEW 1950**

# Heathkits

*have all the Features*



**\$39.50**

*New 1950 Heathkit*  
**PUSH-PULL EXTENDED RANGE  
 5" OSCILLOSCOPE KIT**

*Features*

- The first truly television oscilloscope.
- Tremendous sensitivity .06 Volt RMS per inch deflection.
- Push-pull vertical and horizontal amplifiers.
- Useful frequency range to 2½ Megacycles.
- Extended sweep range 15 cycles to 70,000 cycles.
- New television type multivibrator sweep generator.
- New magnetic alloy shield included.
- Still the amazing price of \$39.50.

The new 1950 Push-Pull 5" Oscilloscope has features that seem impossible in a \$39.50 oscilloscope. Think of it—push-pull vertical and horizontal amplifiers with tremendous sensitivity only six one hundredths of a volt required for full inch of deflection. The weak impulses of television can be boosted to full size on the five inch screen. Traces you couldn't see before. Amazing frequency range clear useful response at 2½ Megacycles made possible by improved push-pull amplifiers. Only Heathkit Oscilloscopes have the frequency range required for television. New type multi-vibrator sweep generator with more than twice the frequency range. 15 cycles to 70,000 cycles will actually synchronize with 250,000 cycle signal. Dual positioning controls will move trace over any section of the screen for observation of any part. New magnetic alloy CR tube shield protects the instrument from outside fields. All the same high quality parts, cased electrostatically shielded power transformer, aluminum cabinet, all tubes and parts. New instruction manual now has complete step by step pictorials for easiest assembly. Shipping Weight 30 lbs. Order now for this winter's use.

**CONVERSION FOR OTHER MODEL HEATHKIT OSCILLOSCOPES**

A conversion for all 03 and 04 scopes is available changing them to the new push-pull amplifiers (does not change the sweep generator). Complete kit includes new chassis, tubes and all parts. For a small investment, add the latest improvements to your present oscilloscope (Except C.R. Tube Shield). Shipping weight 10 lbs.  
 Order 05 Conversion Kit No. 315 ..... **\$12.50**

THE NEW *Heathkit*  
**HANDITESTER KIT**

**MORE Features THAN EVER BEFORE**

- Beautiful streamline Bakelite case.
- AC and DC ranges to 5,000 Volts.
- 1% Precision ceramic resistors.
- Convenient thumb type adjust control.
- 400 Microampere meter movement.
- Quality Bradley AC rectifier.
- Multiplying type ohms ranges.
- All the convenient ranges 10-30-300-1,000-5,000 Volts.
- Large quality 3" built-in meter.

The instrument for all—the ranges you need—beauty you'll enjoy for years and you can assemble it in a matter of minutes—an instrument for everyone. The handiest quality volt-ohmmeter of all. Small enough to put in your pocket yet a full 3" meter. Easy pictorial wiring diagrams eliminate all assembly problems. Uses only 1% precision ceramic divider resistors and wire wound shunts. Twelve different ranges. AC and DC ranges of 10-30-300-1,000-5,000 Volts. Ohms ranges of 0-3,000 ohms and 0-300,000 ohms. Milliampere ranges of 10MA and 100MA. Hearing aid type ohms adjust control fits conveniently under thumb for one hand adjustment. Banana type jacks for positive low resistance connections. Quality test leads included. The high quality Bradley instrument rectifier was especially chosen for linear scales on AC. The modern case was styled by Harrah Engineering for this instrument. The 400 microampere meter movement comes already mounted in the case protected from dust during assembly. An ideal classroom assembly instrument useful for a lifetime. Perfect for radio service calls, electricians, garage mechanics, students, amateurs and beginners in radio. The only quality volt-ohmmeter under \$20.00. An hour of assembly saves you one-half the cost and quality parts give you a better instrument. Order today. Shipping weight 2 lbs.



**\$13.50**

*Note  
 HANDY  
 OHMS  
 ADJUST.*

EXPORT DEPT.  
 13 East 40th St.  
 NEW YORK CITY (16)  
 CABLE: ARLAB-N.Y.

*The* **HEATH COMPANY**

**... BENTON HARBOR 20, MICHIGAN**

RADIO-ELECTRONICS for

# MORE QUALITY in

1950 Heathkits

## The NEW V-4 Heathkit

### VACUUM TUBE VOLTMETER KIT

#### Features

- Meter scale 17% longer than average 4½" meter.
- Modern streamline 200 ua meter.
- New modern streamline styling.
- Burn-out proof meter circuit.
- 24 Complete ranges.
- Isolated probe for dynamic testing.
- Most beautiful VTVM in America.
- Accessory probes (extra) extend ranges to 10,000 Volts and 100 Megacycles.
- Uses 1% precision ceramic divider resistors.
- Modern push-pull electronic voltmeter circuit.
- Electronic AC circuit. No current drawing rectifiers.
- Shatterproof plastic meter face.

The new Heathkit Model V-4 Vacuum Tube Voltmeter has dozens of improvements. A new modern streamlined 200 microampere meter has Alnico V magnet for fast, accurate readings. The new electronic AC voltmeter circuit incorporates an entire new balance control which eliminates contact potential and provides greater accuracy. New simplified switches for quicker assembly. New snap-in battery mounting is on the chassis for easy replacement.

The Heathkit VTVM is the only kit giving all the ranges. Check them — DC and AC full scale linear ranges of 0-3V, 0-10V, 0-30V, 0-100V, 0-300V, 0-1000V and can be extended to 0-3000V and 0-10,000V DC with accessory probe at slight extra cost. Electronic ohmmeter has six ranges measuring resistance accurately from .1 ohm to one billion ohms. Meter pointer can be offset to zero center for FM alignment.

The DC probe is isolated for dynamic measurements. Has db scale for making gain and other audio measurements.

The new instruction manual features pictorial diagrams and step-by-step instructions for easy assembly. The Heathkit VTVM is complete with every part — 110V transformer operated with test leads, tubes, light aluminum cabinet for portability, giant 4½" 200 microamp meter and complete instruction manual.

Order now and enjoy it this entire season. Shipping weight 8 lbs., Model V-4

Accessory: 10,000V high voltage probe, No. 310, \$4.50.  
Accessory: RF crystal diode probe kit extends RF range to 100 Mc., No. 309, \$6.50.



**\$24.50**

## New 1950 VERNIER TUNING R.F. Heathkit

### SIGNAL GENERATOR KIT

#### Features

- New 5 to 1 ratio vernier tuning for ease and accuracy.
- New external modulation switch—use it for fidelity testing.
- New precision coils for greater output.
- Cathode follower output for greatest stability.
- 400 cycle audio available for audio testing.
- Most modern type R.F. oscillator.
- Covers 150Kc. to 34Mc. on fundamentals and calibrated strong harmonics to 102 Mc.

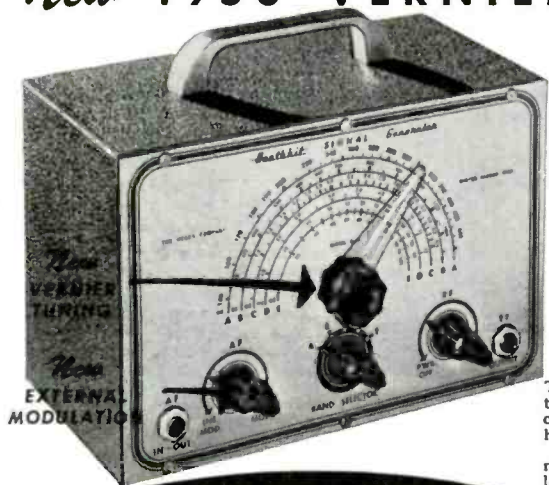

**\$19.50**

The most popular signal generator kit has been vastly improved—the experience of thousands combined to give you the best. Check the features in this fine generator and consider the low price \$19.50. A best buy for any shop, yet inexpensive enough for hobbyists. Everyone can have an accurate controlled source of R.F. signal voltage.

The new features double the value—think of being able to make fidelity checks on receivers by inserting a variable audio signal. Internal 400 cycle saw-tooth audio oscillator modulates R.F. signal and is available externally for audio testing. The new 5 to 1 ratio vernier drive gives hairline tuning for maximum accuracy in scale settings. The coils are already precision wound and calibrated. Uses turret type coil and switch assembly for ease of construction. The generator is 110 V. 60 cycle transformer operated and comes complete in every detail—cabinet—tubes—coils—beautiful two color calibrated panel and all small parts—new step-by-step pictorial diagrams and complete instruction manual make assembly a cinch even for novices. Why try to get along without a signal generator when you can have the best for less than a twenty dollar bill. Better order it now. Shipping weight 7 lbs. **\$19.50**

#### CONVERSION KIT FOR G-1 GENERATORS

Conversion kit for G-1 generators for vernier tuning and external modulation includes new high band coil for greater output. Gives all the features of new G-5 listed above. Order G-5 Conversion Kit No. 316. **\$4.50**

EXPORT DEPT.  
13 East 40th St.  
NEW YORK CITY (16)  
CABLE: ARLAB-N.Y.

The **HEATH COMPANY**

... BENTON HARBOR 20, MICHIGAN

# Beauty · Quality · Economy



Only  
**\$69.50**

Nothing  
ELSE TO BUY

## New Heathkit IMPEDANCE BRIDGE KIT

A LABORATORY INSTRUMENT NOW WITHIN  
THE PRICE RANGE OF ALL

Measures Inductance from 10 microhenries to 100 henries capacitance from .00001 MFD to 1000 MFD. Resistance from .01 ohms to 10 megohms. Dissipation factor from .001 to 1. "Q" from 1 to 1000.

Ideal for schools, laboratories, service shops, serious experimentors.

An impedance bridge for everyone — the most useful instrument of all, which heretofore has been out of the price range of serious experimentors and service shops. Now at the lowest price possible. All highest quality parts. General Radio main calibrated control. General Radio 1000 cycle hummer. Mallory ceramic switches with 60 degree indexing — 200 micro-amp zero center galvanometer — 1/2 of 1% ceramic non-inductive decade resistors. Professional type binding posts with standard 3/4" centers. Beautiful birch cabinet. Directly calibrated "Q" and dissipation factor scales. Ready calibrated capacity and inductance standards of Silver Mica, accurate to 1/2 of 1% and with dissipation factors of less than 30 parts in one million. Provisions on panel for external generator and detector. Measure all your unknowns the way laboratories do — with a bridge for accuracy and speed.

Internal 6 volt battery for resistance and hummer operation. Circuit utilizes Wheatstone, Hay and Maxwell circuits for different measurements. Supplied complete with every quality part — all calibrations completed and instruction manual for assembly and use. Deliveries are limited. Shipping weight, approximately 15 lbs.

## Heathkit CONDENSER CHECKER KIT

**\$19.50**



### Features

- Power factor scale
- Measures resistance
- Measures leakage
- Checks paper-mica-electrolytics
- Bridge type circuit
- Magic eye indicator
- 110V. transformer operated
- All scales on panel

Checks all types of condensers, paper-mica-electrolytic-ceramic over a range of .00001 MFD. to 1000 MFD. All on readable scales that are read direct from the panel. NO CHARTS OR MULTIPLIERS NECESSARY. A condenser checker anyone can read without a college education. A leakage test and polarizing voltage for 20 to 500 volts provided. Measures power factor of electrolytics between 0% and 50%. 110V. 60 cycle transformer operated complete with rectifier and magic eye tubes, cabinet, calibrated panel, test leads and all other parts. Clear detailed instruction for assembly and use. Why guess at the quality and capacity of a condenser when you can know for less than a twenty dollar bill. Shipping weight, 7 lbs. Model C-2.

## New Heathkit TELEVISION ALIGNMENT GENERATOR KIT



**\$39.50**

Nothing ELSE TO BUY

Everything you want in a television alignment generator. A wide band sweep generator covering all TV frequencies 0-46 54 to 100 — 174 to 220 Megacycles, a marker indicator covering 19 to 42 Megacycles, AM modulation for RF alignment — variable calibrated sweep width 0-30 Mc. — mechanical driven inductive sweep. Husky 110V. 60 cycle power transformer operated — step type output attenuator with 10,000 to 1 range — high output on all ranges — band switching for each range — vernier driven main calibrated dial with over 45 inches of calibration — vernier driven calibrated indicator marker tuning. Large grey crackle cabinet 16 1/8" x 10 3/8" x 7-3/16". Phase control for single trace adjustment. Uses three high frequency triodes plus 5Y3 rectifier — split stator tuning condensers for greater efficiency and accuracy at high frequencies — this Heathkit is complete and adequate for every alignment need and is supplied with every part — cabinet — calibrated panel — all coils and condensers wound, calibrated and adjusted. Tubes, transformer, test leads — every part with instruction manual for assembly and use. Actually three instruments in one — TV sweep generator — TV AM generator and TV marker indicator.

EXPORT DEPT.  
13 East 40th St.  
NEW YORK CITY (16)  
CABLE: ARLAB-N.Y.

The **HEATH COMPANY**

... BENTON HARBOR 20, MICHIGAN

RADIO-ELECTRONICS for



# all in HEATHKITS...

## Heathkit TUBE CHECKER KIT

### Features

1. Measures each element individually
2. Has gear driven roller chart
3. Has lever switching for speed
4. Complete range of filament voltages
5. Checks every tube element
6. Uses latest type lever switches
7. Uses beautiful shatterproof full view meter
8. Large size 11" x 14" x 4" complete
9. Checks new 9 pin piniaures

Check the features and you will realize that this Heathkit has all the features you want. Speed — simplicity — beauty — protection against obsolescence. The most modern type of tester — measures each element — beautiful Bad-Good scale, high quality meter — the best of parts — rugged oversize 110V. 60 cycle power transformer — finest of Mallory switches — Centralab controls — quality wood cabinet — complete set of sockets for all type tubes including blank spare for future types — fast action gear driven roller chart uses brass gears to quickly locate and set up any type tube. Simplified switching cuts necessary time to minimum and saves valuable service time. Short and open element check. No matter what arrangement of tube elements, the Heathkit flexible switching arrangement easily handles it. Order your Heathkit Tube Checker today. See for yourself that Heath again saves you  $\frac{2}{3}$  and yet retains all the quality — this tube checker will pay for itself in a few weeks — better build it now.

Complete with detail instructions — all parts — cabinet — roller chart — ready to wire up and operate. Shipping Wt., 15 lbs.



Only  
**\$29<sup>50</sup>**

Nothing  
ELSE TO BUY

## Heathkit SINE AND SQUARE WAVE AUDIO GENERATOR KIT



Nothing  
ELSE TO BUY

**\$34<sup>50</sup>**

Experimenters and servicemen working with a square wave for the first time invariably wonder why it was not introduced before. The characteristics of an amplifier can be determined in seconds compared to several hours of tedious plotting using older methods. Stage by stage, amplifier testing is as easy as signal tracing. The low distortion (less than 1%) and linear output ( $\pm$  one db.) make this Heathkit equal or superior to factory built equipment selling for three or four times its price. The circuit is the popular RC tuning circuit using a four gang variable condenser. Three ranges 20-200, 200-2,000, 2,000-20,000 cycles are provided by selector switch. Either sine or square waves instantly available at slide switch. All components are of highest quality, cased 110V. 60 cycle power transformer. Mallory F.P. filter condensers, 5 tubes, calibrated 2 color panel, grey crackle aluminum cabinet. The detailed instructions make assembly an interesting and instructive few hours. Shipping Wt., 13 lbs.

## New Heathkit BATTERY ELIMINATOR KIT

Nothing  
ELSE  
TO BUY



**\$22<sup>50</sup>**

Now a bench 6 Volt power supply kit for all auto radio testing. Supplies 5 - 7 $\frac{1}{2}$  Volts at 10 Amperes continuous or 15 Amperes intermittent. A well filtered rugged power supply uses heavy duty selenium rectifier, choke input filter with 4,000 MFD of electrolytic filter. 0 - 15 Volt meter indicates output. Output variable in eight steps. Excellent for demonstrating auto radios. Ideal for servicing — can be lowered to find sticky vibrators or stepped up to equivalent of generator overload — easily constructed in less than two hours. Complete in every respect. Shipping Wt., 18 lbs.

## NEW Heathkit SIGNAL TRACER AND UNIVERSAL TEST SPEAKER KIT

Nothing  
ELSE  
TO BUY

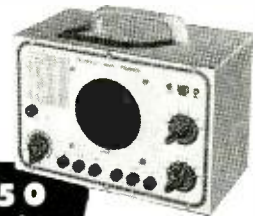

**\$19<sup>50</sup>**

The popular Heathkit signal tracer has now been combined with a universal test speaker at no increase in price. The same high quality tracer follows signal from antenna to speaker — locates intermittents — defective parts quicker — saves valuable service time — gives greater income per service hour. Works equally well on broadcast — FM or TV receivers. The test speaker has assortment of switching ranges to match push pull or single output impedance. Also test microphones, pickups — PA systems — comes complete — cabinet — 110V. 60 cycle power transformer — tubes, test probe, all parts and detailed instructions for assembly and use. Shipping Wt., 8 lbs.

EXPORT DEPT.  
13 East 40th St.  
NEW YORK CITY (16)  
CABLE: ARLAB-N.Y.

The **HEATH COMPANY**

... BENTON HARBOR 20, MICHIGAN

MAY, 1950



*Quiet  
as a mouse*

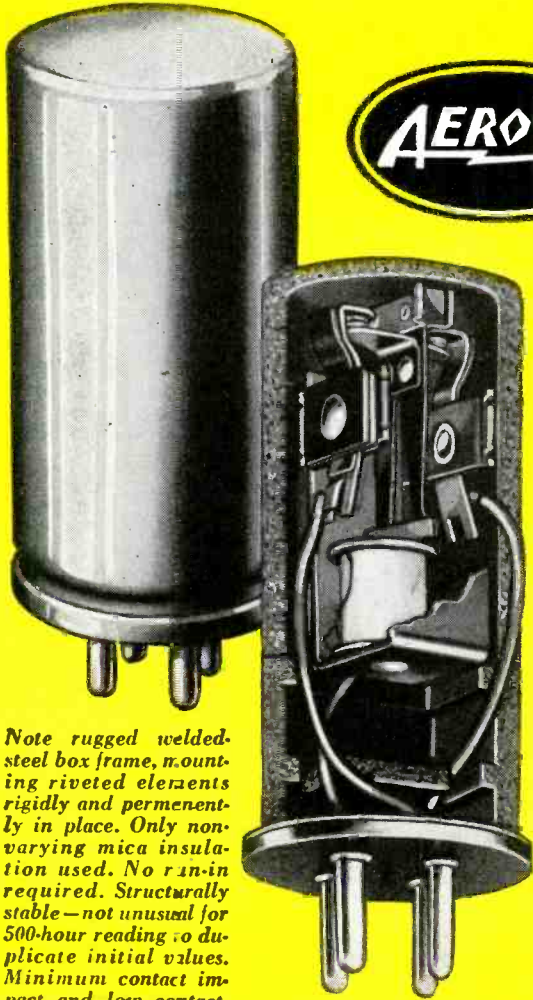

# VIBRATORS

• So very quiet! You'll doubt the Aerovox Vibrator\* is running until you've turned up the volume control.

Here's the first postwar vibrator. Radically new design—outcome of systematic engineering effort to eliminate annoyances experienced with vibrators. Provides brand new performance thrill with any auto-radio or other vibrator-powered equipment. Definitely another milestone in vibrators.

Note rugged welded-steel box frame, mounting riveted elements rigidly and permanently in place. Only non-varying mica insulation used. No run-in required. Structurally stable—not unusual for 500-hour reading to duplicate initial values. Minimum contact impact and low contact-point erosion. Almost impossible for unit to close or stick. Heat generation low enough to sustain operation at 185° F.

Just compare!

Yes sir, comparative tests are invited. Literature on request. Let us collaborate on your vibrator problems and needs.

•U.S. Patents Pending

Standard and special types. Also Universal Replacements serving greatest number of auto-radio models with minimum inventory. For the best in replacements, insist on the "Quiet Mouse" yellow and black carton vibrator stocked by Aerovox distributors!



# VIBRATORS

FOR AUTO-RADIO • POLICE RADIO • AVIATION RADIO • LABORATORY AND OTHER POWER PACKS • MARINE RADIO • PORTABLE RADIO • FARM RADIO • INDUSTRIAL ELECTRONICS • ETC.  
AEROVOX CORPORATION • NEW BEDFORD • MASSACHUSETTS

Another **NATIONAL** TELEVISION First!

**A SENSATIONAL NEW BOOSTER FEATURING A TURRET TUNER**

The turret tuner is recognized as the most efficient television input tuning device yet designed because of (1) its exceptionally high gain and (2) its uniform bandwidth on all channels. It is used in today's finest television receivers. Now, for the first time, National makes available all the advantages of a turret tuner in a truly sensational-performing new television booster.

**COMPARE THESE FEATURES:**

- (1) Turret tuner with an individually tuned set of coils for each channel.
- (2) Removable polystyrene coil-mounting contact panels.
- (3) A single 6AK5 for maximum usable gain.
- (4) A built-in power transformer (not AC-DC — no "hot" chassis).
- (5) Selenium rectifier for long life.
- (6) Channel selector and fine tuning in a single, easy-to-operate, dual-purpose control.
- (7) Pilot light illuminates selected channel.

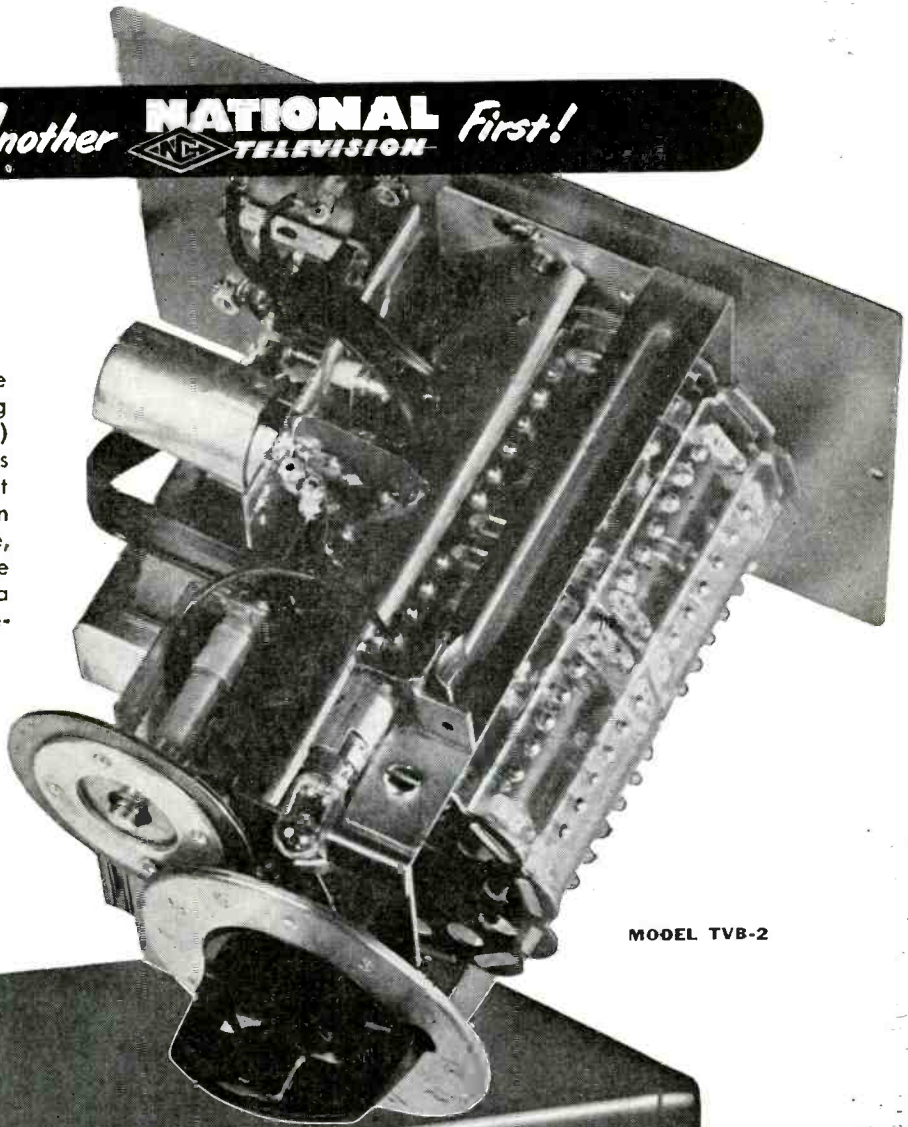

MODEL TVB-2



The new National Booster is housed as beautifully as it performs in a smart, modern, metal cabinet finished in special wear-resistant mahogany enamel, with a handsome brass and plastic tuning knob.

**\$39.95**  
list price

P.S. No other booster has a turret tuner!

**national**  
EST. 1914  
**NATIONAL COMPANY, Inc.**  
MALDEN, MASSACHUSETTS

RADIO-ELECTRONICS for

# THESE LEADING SET MAKERS

Emerson Admiral Westinghouse  
 hallicrafters PHILCO STROMBERG-CARLSON  
 Motorola Spartan TRAV-LER GAROD SETHCELL-CARLSON, INC.  
 airOking Sentinel Majestic  
 CROSLLEY

Seen these Hytron firsts in popular new TV sets? The prominent TV set makers shown are using them. And the list is growing.

DuMont, for example, now uses the 1X2 and 6BQ6GT. You'll see many more of these famous tubes. And many more new Hytron types designed for low-cost TV for the mass market. When you buy these Hytron firsts, follow the leading set manufacturers. Buy the original. Buy Hytron!

choose one or more of  
 THESE HYTRON TV FIRSTS

HYTRON TV FIRST  
 1X2 compact, high-voltage TV rectifier.



HYTRON TV FIRST  
 6U4GT high-performance damping diode.



HYTRON TV FIRST  
 16RP4 original rectangular TV picture tube.



HYTRON TV FIRST  
 6BQ6GT, 258Q6GT extra-performance deflection amplifiers.



HYTRON TV FIRST  
 12BH7 twin-triode sweep amplifier with superior efficiency.

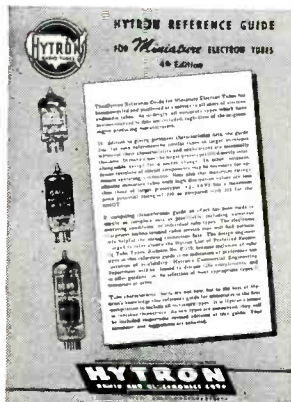

## NEW 4th EDITION Hytron Reference Guide for Miniature Electron Tubes

Miniature types are multiplying fast. You need this Hytron Reference Guide. Originated by Hytron, it is unique. Lists all miniatures to date, regardless of make. Six pages of pertinent data. 132 miniatures — 41 of them new. 70 basing diagrams. Lists similar larger prototypes. Free from your Hytron jobber. Get your copy of this old friend brought up to date — today.

OLDEST MANUFACTURER OF RECEIVING TUBES  
**HYTRON**  
 RADIO AND ELECTRONICS CORP.

MAIN OFFICE: SALEM, MASSACHUSETTS



# **NOV!** Convert 10"-12½"

**Quickly, Profitably, Easily with**

**NEW! NORELCO DUO-VUE**  
world's first dual-purpose TV offers  
3' x 4' picture — \$199.50 list\*

**NEW! PROTELGRAM "CONVERSION PACKAGE"**  
makes possible huge 234 sq. in.  
picture for trade-in buyers



This 2½" 3NP4 is smallest projection tube on market, is lowest in cost (\$19.50 retail), produces largest home picture (3' x 4').

NORTH AMERICAN  
PHILIPS  
COMPANY, INC.



**PROTELGRAM**

North American Philips has really **BIG PROFIT NEWS** for you—and **BIGGER, BETTER PROTELGRAM** TV pictures for your customers, up to 3' x 4' in the sensational **NORELCO DUO-VUE** now making its world premiere at \$199.50 — more television picture for less money than ever before offered!

What is there in it for you? **PROFITS** from **PROTELGRAM's** Four-Way Plan described on the right.

Philips makes it easy and profitable for you to—

1. Sell **PROTELGRAM** to set builders interested in bigger pictures — 13½" x 18".

2. Sell **PROTELGRAM** for custom-built, large-screen installation, up to 3' x 4' for homes, clubs, bars, hotels, etc.

3. Sell **NORELCO DUO-VUE**, television's newest, finest and biggest picture used with the customer's direct-view table set to produce 3' x 4' pictures on a home-movie screen. A flip of a switch selects either picture, and you can connect **DUO-VUE** to almost any table-model receiver in less than an hour.

4. Sell **PROTELGRAM** in a conversion cabinet to customers wanting to convert their 10 or 12½" direct-view receivers to a picture larger than a 20" tube gives. And you can make the conversion in less than one hour following the simple, straightforward instructions provided.

Right now is the time to make extra profits with **PROTELGRAM**. Read every word of this ad. Then get in touch with your distributor or send the coupon now for all the facts.

*\*Prices slightly higher west of Rockies. Connection charges extra.*

**NORTH AMERICAN PHILIPS COMPANY, INC.**

100 E. 42nd Street, New York 17, N. Y.





EDW. H. GUILFORD,  
Vice President

I can train you to pass your FCC License Exams in a few short weeks if you've had any practical radio experience — amateur, Army, Navy, radio servicing, or other. My time-proven plan can help put you, too, on the road to success.

Let me send you **FREE**  
the entire story

Just fill out the coupon and mail it. I will send you, free of charge, a copy of "How to Pass FCC License Exams," plus a sample FCC-type Exam, and the amazing new booklet, "Money Making FCC License Information."

# How to Pass FCC *Commercial* Radio Operator License Exams

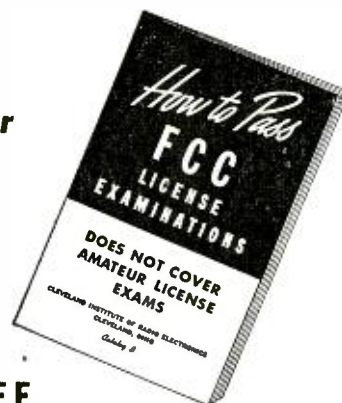

**FREE**

Tells where to apply for and take FCC examinations, location of examining offices, scope of knowledge required, approved way to prepare for FCC examinations, positive method of checking your knowledge before taking the examinations.

**Get your FCC ticket in a FEW SHORT WEEKS**

**IT'S EASY IF YOU USE CIRE SIMPLIFIED TRAINING AND COACHING METHODS AT HOME IN YOUR SPARE TIME**

**Get This Amazing New Booklet**

1. Tells of Thousands of Brand-New Better Paying Radio Jobs Now Open to FCC License Holders.
2. Tells How We Guarantee to Train and Coach You Until You Get Your FCC License.
3. Tells How Our Amazing Job-Finding Service Helps You Get the Better Paying Radio Job Our Training Prepares You to Hold.

Get your license easily and quickly and be ready for the jobs open to ticket holders which lead to \$3000 to \$7500 (average pay reported by FCC nationwide survey). Employers often give preference to license holders, even though a license is not required for the job. Hold an FCC "ticket" and the job is yours!

**CIRE Job-Finding Service  
Brings Amazing Offers of Jobs!**

"I am working at WRJM as transmitter engineer. Received this position in response to one of the employment applications sent me upon completion of my course and the receiving of my Diploma. I received my 1st class Radiophone License on March 2, 1949. George Hugo, New Haven, Conn.

"Thanks for the Application for Employment you recently prepared for me. I found satisfactory employment. I submitted 57 letters, enclosing the resume you supplied. I received 17 letters indicating my application was filed for future reference, 3 telephone calls, and 1 letter requesting personal interviews. "As a result, I am employed in a development engineering capacity."—Kenneth Forsberg, Cambridge, Mass.

Ours is the Only Home Study Course of Coaching and Training Primarily Planned to Lead Directly to an FCC Commercial License.

**Get ALL THREE FREE**

**YOUR FCC TICKET IS ALWAYS RECOGNIZED IN ALL RADIO FIELDS AS PROOF OF YOUR TECHNICAL ABILITY**

**Don't Waste Valuable Time  
MAIL COUPON TODAY!**

Don't put off getting this valuable information. Good jobs in radio need men like you. You can earn higher income, have a bank account, enjoy vacations, and have easier and better living. But you must have your FCC License. Hurry! Fill out the coupon right now and mail it. There is no obligation. You owe it to yourself to get the full story NOW.

**CLEVELAND INSTITUTE OF RADIO ELECTRONICS**  
Desk RE-17 4900 Euclid Bldg., Cleveland 3, Ohio

Approved for Veteran Training under the "G.I. Bill of Rights"

**CLEVELAND INSTITUTE OF RADIO ELECTRONICS**  
Desk RE-17 4900 Euclid Bldg., Cleveland 3, Ohio  
Address to Desk No. to Avoid Delay

I want to know how I can get my FCC ticket in a few short weeks. Send me your FREE booklet, "How to Pass FCC License Examinations" (does not cover exams for Amateur License), as well as a sample FCC-type exam and the amazing new booklet, "Money-Making FCC License Information."

NAME.....

ADDRESS.....

CITY..... ZONE..... STATE.....

Veterans check for enrollment information under G.I. Bill.



# The Future of Electronics

. . . *The greatest art in History is still in its infancy* . . .

By HUGO GERNSBACK

**M**OST of our human activities during the next half century will be affected in increasingly greater impact by electronics than by the peacetime uses of atomics and atomic energy, according to William C. White, scientist of General Electric Research Laboratories.

In a paper delivered recently at Rochester, N. Y., before the Institute of Radio Engineers, Mr. White declared that the world is embarking on a technological revolution which will be equivalent in its impact to the Industrial Revolution of the past century.

Here are a few highlights of Mr. White's address: "The industrial revolution made muscle power obsolete while the technological revolution now under way, wherein routine work is being taken over by electronic machines, will make unnecessary jobs where a person performs repetitious operations as a mere reflex, without thought.

"Electronic-science now has at its disposal all elements needed to make machines capable of doing non-thinking jobs.

"As a prime example of such a job, take mail-sorting. If a system of addressing letters with certain code markings were adopted, an electric eye could scan mail. Then signal sorting machinery would route pieces of mail to their proper slots—even into the mailbag of the proper mailman.

"Routine jobs now done by human beings couple one or more of the senses with muscular reflexes. Electronics provides quick and accurate responses, controlling machinery with precision. Moreover, every day brings news of new instruments which can duplicate, and usually excel, human senses.

"The social implications of this trend are, of course, tremendous. It is something humanity will have to adapt itself to, for it cannot easily be stopped.

"Ultimately, it will mean more freedom for mankind, just as the industrial revolution made men more free. Unquestionably, this revolution, well on its way, will have a much greater effect on our ways of life than peacetime uses of atomic energy."

Mr. White's thought-provoking observations of course only scratch the surface of the future of electronics. There is no visible end to the magic of the young art—the more electronics expands the greater the vistas it reveals.

For those who have not followed closely the intricate and complex mazes of electronic developments—even now on the engineering and designing boards—we may add the following:

**Manless robot factory.** Certain factories where work has been standardized will in the near future be run practically without human workers. There will be only a few technical supervisors to check the output of the machines and see that the quality is up to par. The raw material comes in at one end of the plant, the finished product—packed in boxes, barrels, or other suitable containers—leaves at the other side of the factory. No human hands touch the product. The

machines, controlled by electronics, do all the intricate work, better, faster and more efficiently than humans.

There are indeed such plants in existence even today, but they are specialized ones. New and more complex robot factories are coming into use continually. It is even possible today to run huge printing plants, that print magazines such as the one you are reading now, in manless robot printing establishments. While the money investment to build such a plant is formidable, the cost per finished magazine would be almost halved. The reason: cost of labor today is over half the total cost of a magazine.

**Electronicked Automobiles.** The human can no longer cope adequately with his high-speed car. His reactions are now far too slow to prevent the majority of accidents. By the time he has perceived the danger and decided to circumvent it,  $\frac{3}{4}$  second has elapsed. During that time the car has traveled over 75 feet, (at 68 mph) and the usual crash has occurred.\* Electronics, it is believed, could do away with over 75% of all accidents. A combination of radar, *capacity effects between cars*, plus photo-electric cells could automatically steer cars to prevent most collisions. Electronic "perception" has practically no time lag—in moments of danger an electronic robot would take over the steering and brakes, thus preventing most collisions. Obviously all cars would have to be electronicked to make autoing reasonably safe.

**Electronic Fishery.** The world's population now increases faster than at anytime in history, yet our greatest source of food—the ocean—is hardly touched. Fish is still expensive albeit our most abundant and healthful food. The reason is we still are catching fish as they were caught by the Phoenicians 5,000 years ago—with prehistoric nets (one of the oldest of man's inventions). Recently—using sonar and other electronic means—we have learned how to catch fish efficiently—not by waiting for the fish to come to the fishing vessels, but by going to where the fish congregate in schools by the thousands, often by the millions. But we catch only a puny few with our small nets—our effort compares to catching with a butterfly net the billions of locusts that swoop down on us during a plague. Clearly, specially engineered ships of a fairly large size—over 15,000 tons—that *use no nets* are needed. Instead such a ship would have heroic sized extensible telescopic tubular scoops which could reach down over one hundred feet below the ocean's surface. Huge powerful pumps would then suck up water and fish into the ship's hold where electronic instruments would automatically assort and classify the various types and sizes of fish, then store them in large tanks. On a single trip such a "fish-factory" could catch from 5,000 to 7,500 tons of fish—against the few tons of the present-day fishing vessels. This would bring down the cost of fish to a fraction of what it is at present, yet leave the operators a high profit.

\*The *average* reaction time for a healthy driver is about  $\frac{3}{4}$  second. A few drivers show a reaction time down to  $\frac{1}{2}$  second, but if the traffic problem ahead becomes complicated, his reaction will take longer.



# Review of TV Boosters

**Preamplifier units often improve weak stations and reduce much interference**

**M**ANY TV set owners within the service areas of TV stations fail to receive acceptable pictures because of inadequate antennas or poor receiving locations. Others live in fringe areas where signals are too weak to produce good pictures. Under such adverse receiving conditions, a booster or preamplifier used in conjunction with the best possible antenna increases the possibilities of reliable reception.

In addition to improving the signal-to-noise ratio, a good booster will minimize or eliminate adjacent-channel

interference; fundamentals, images and harmonics from amateur, commercial, FM, and public service transmitters; and spurious radiations from nearby TV and FM receivers. Regardless of the design of the TV receiver, its performance depends largely on its proximity to TV broadcast stations and on the efficiency of its antenna system. Because the booster is connected between the antenna and the set, it can be considered as part of a good antenna system.

A number of boosters are available to the consumer. Nine of these have

been reviewed and are discussed in this article. A number of features are common to most of them. All have filament or power transformers which must be operated from 117-volt, 60-cycle lines. The booster which does not have a selenium rectifier and a 6AK5 amplifier tube is a rare one. Unless noted, the boosters do not have direct connection to the a.c. line.

## Anchor ARC-101-50

The circuit of this preamplifier (Fig. 1), is similar to that used in several boosters to be described. It covers the TV spectrum in two bands. Permeability-tuned input and output circuits are changed by a bandswitch.

The input and output circuits have 300-ohm impedances. A novel impedance-matching device is supplied with the unit. It consists of a 24-inch length of 300-ohm ribbon split 12 inches down the center. The unsplit end is connected to the antenna posts on the receiver. The split ends are wrapped around each other for one or two turns, then connected to the output posts on the booster.

The number of turns to be used is determined by tuning the set and booster to channel 7 or 8 and adjusting the matching line for the best picture. Tune the booster and set to channel 13. If dark bars appear, the booster is oscillating and turns must be taken off

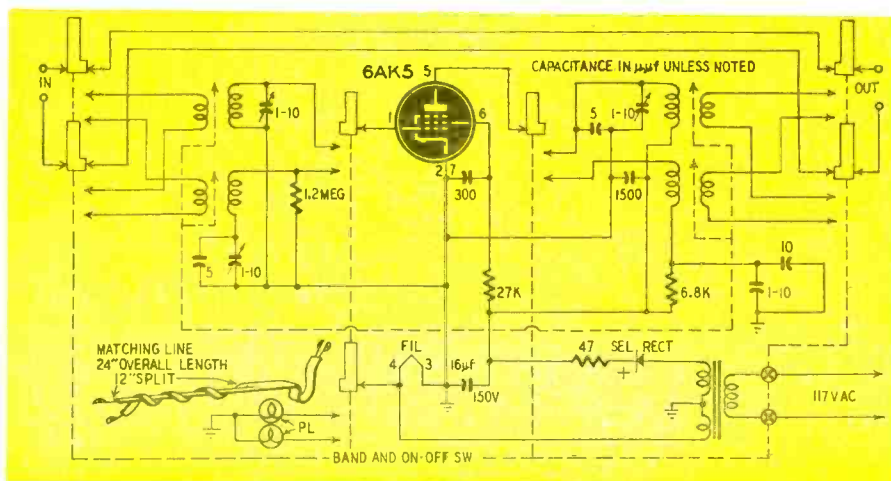

Fig. 1—The Anchor ARC-101-50 is permeability tuned on high and low bands.

the line until oscillations cease. When the booster is matched to the receiver, it will not oscillate on channel 13. There will be a noticeable gain when both units are returned to channel 7 or 8. The matching line is shown below the schematic in Fig. 1.

The ARC-101-50 has a brown, leatherette-covered, metal cabinet 8½ inches wide, 4 inches high, and 4½ inches deep. A single tuning control is ganged to separate slide-rule dials for each band. The dial in use is illuminated by a pilot light.

**Astatic AT-1**

Called Channel Chief, the Astatic AT-1 booster has more tubes than any of the others. This unit, shown in Fig. 2, uses two cascade-connected 6AK5's for each band. Separate ganged controls are used in the grid circuits of the first and second amplifiers. The plate circuits are broad-banded. Band-switch and power switch are combined. The unused amplifiers are turned off by removing voltage from their screen grids. Gain is controlled by varying the screen voltage on the tubes in use. The chassis is connected to one side of the a.c. line so it may be hot under some conditions. However, it is almost impossible to touch the chassis while it is enclosed in its cabinet.

The Channel Chief is built into a mahogany-finished, slope-front, wooden cabinet 8½ inches wide, 6½ inches high, and 7¾ inches deep at the bottom. The neon-type pilot lamp is visible through a small aperture in the front panel.

**Jerrold Model TV-FM (Series B)**

The series B TV-FM booster is similar to an earlier model described in the article "Television Accessories for Improved Reception" in the March, 1949, issue. The principal difference between the models is that the later one has a built-in impedance-matching device called the *Match-A-Trans* which matches the output impedance of the booster to the input impedance of the set. The plate circuit of the series B is peaked by varying the position of a slug inside one of the coils instead of using a trimmer capacitor as in the earlier model.

The series B is a single-ended 6AK5 amplifier having switch-tuning in the input and output circuits. A trimmer type tuning capacitor is in the grid circuit for fine tuning. The tuning switch has one position for each low-band channel, one for FM, one for channel 7, and three positions for channels 8-9, 10-11, and 12-13, respectively. It has no pilot light, so the user may forget to turn it off when it is not in use.

This booster is in a brown, plastic case, 7 inches wide, 4½ inches high, and 6½ inches deep overall.

**Masco MTB-13X**

This booster has separate 6AK5 am-

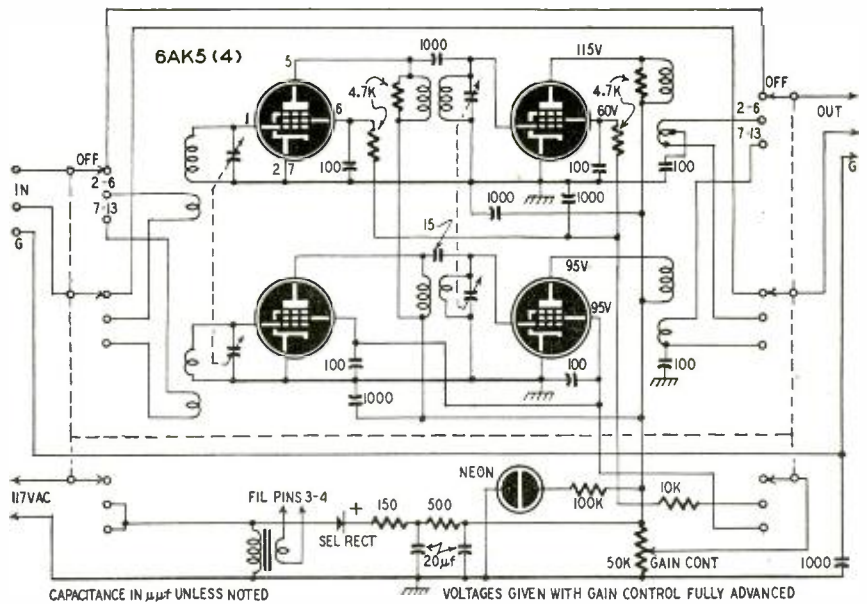

Fig. 2—The Astatic AT-1 has two separately tuned 6AK5's for each band.

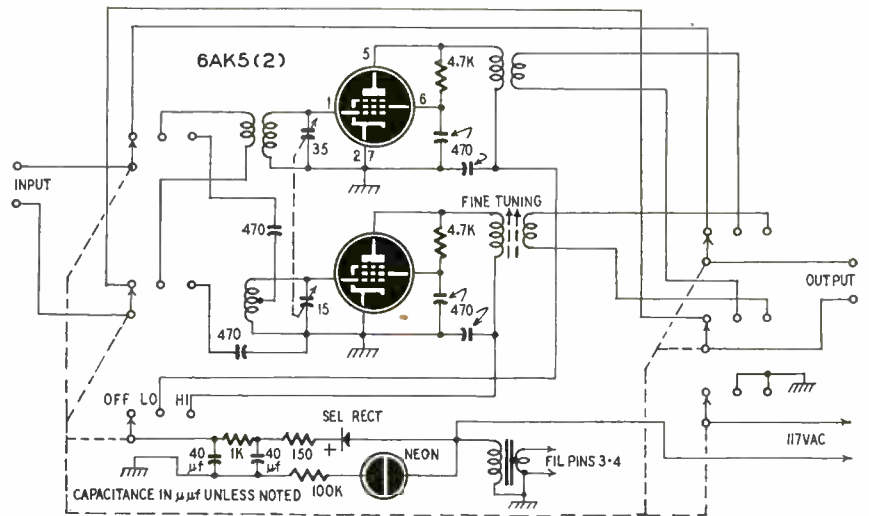

Fig. 3—High-band fine-tuning control peaks the permeability-tuned plate circuit.

plifiers for high and low bands. Both tubes are used in circuits which are neither triode or pentode connections. See Fig. 3. Note that the screen voltage is taken from the plates through 4,700-ohm resistors. Inductive coupling is used between the antenna and grid coil on the low band and capacitive coupling is used on the high band. A high-band fine-tuning control peaks the permeability-tuned plate circuit. The low band does not have a fine-tuning control.

The input and output impedances are not given. The manufacturer states that if the booster does not improve performance of the set on the low band, it may be necessary to reverse the leads at the output terminal of the booster. To improve reception on the weakest high-band channel, instructions are to grasp the antenna lead-in close to the booster. Observe the picture as you slide your hand along the line. There will be two points at which there

is no change in the picture. Measure the distance between these points and shorten the lead-in by this much. Use the same procedure on the line between the booster and set.

Although one side of the a.c. line is connected to the chassis, there is little danger of shock so long as the unit is in its cabinet. Two metal screws recessed into the back cover are hot and should be avoided. It is reported that these are insulated in later models.

The MTB-13X is in a walnut-finished wooden cabinet 5½ inches wide, 5½ inches high, and 5 inches deep. A neon-type pilot lamp is used.

**Regency DB-213**

The Regency DB-213 (Fig. 4), is the only booster reviewed which uses triode amplifiers. A 6J6 is used as a neutralized, push-pull, r.f. amplifier on each band. Capacitive coupling is used between the antenna and grid circuits of each amplifier. The input and output

Circuits of each amplifier are tuned by varying the position of a slug inside the coil forms. Tuning slugs for each band are ganged and brought out to a separate control on the panel. Provisions are made at the input and output for balanced 300-ohm lines or 72-ohm coaxial cables.

The DB-213 is housed in a gray,

Turning the control to ON puts the booster in operation by applying plate voltage, and connects the amplifier between the antenna and receiver.

Input and output connections shown in the diagram are for 300-ohm lines. For 72-ohm output or input impedances, cut the jumper between the eyelets. Connect jumpers between the eyelets

bined tube and wiring capacitances. The coils and tuning control are ganged to an illuminated slide-rule type dial. See Fig. 7. The unit uses a 6AK5. A diode-connected 6C4 is the rectifier for the unit.

**Telekit**

This booster, like most of the others, uses a 6AK5 pentode. It has a switch-type tuner with a capacitor-type fine-tuning control. This is the only one-tube model which has an r.f. gain control. Sensitivity is controlled by varying the screen voltage.

No provisions are made for bypassing the booster when it is not being used. It must be used at all times that the set is in operation or the antenna will have to be connected directly to the set.

The input and output circuits are loaded with 300-ohm resistors to provide a match for 300-ohm lines. One side of the a.c. line is tied directly to the chassis. Two large holes in the back of the 8 1/4 x 6 3/4 x 4 3/4-inch wooden cabinet present a shock hazard whenever the unit is moved while it is plugged in.

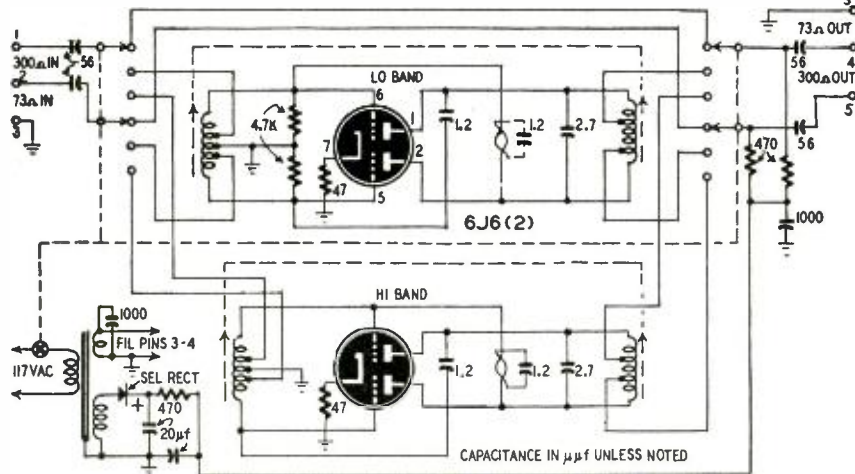

Fig. 4—The Regency DB-213. The 1.2-µf capacitors are simply twisted wires.

hammer-tone-finished, metal cabinet 5 1/4 inches wide, 4 inches high, and 3 3/4 inches deep. There is no pilot light so it may be left on by mistake.

**RMS SP-4**

This is a single-tube, bandswitching, permeability-tuned booster having a circuit and physical construction similar in many respects to the Anchor ARC-101-50 shown in Fig. 1. The input and output impedances are 300 ohms. The manufacturer supplies a strip of metal foil which is to be wrapped around the lead-in and line between booster and set at points where the best picture is obtained on the weakest channel.

The SP-4 has an illuminated slide-rule dial on the front of an oak-finished wooden cabinet, 8 inches wide, 6 1/2 inches high, and 4 inches deep.

**Standard B-50**

The model B-50 is one of the more unusual of the boosters examined. It tunes from channel 2 through channel 13 without manual switching. The plate and grid circuits are tuned by a wiper which contacts printed-circuit inductors in the input and output circuits. A metal vane, ganged to the wiper, acts as a variable capacitor between sections of the inductor, thus providing a fine-tuning action. The circuit of the model B-50 is shown in Fig. 5 and the printed-circuit tuning elements are shown in Fig. 6.

A novel feature of this booster is that it has a receptacle on the rear for plugging in the TV line cord. The control switch is marked OFF—SET—ON. When the switch is off, the set and booster are disconnected from the power line. When it is turned to SET, the booster filament is lighted and the antenna connects to the televiser.

and screw terminals. Connect the center terminal of the coax to terminal 1 and the shield to terminal 2. A separate ground lead connects to the chassis of

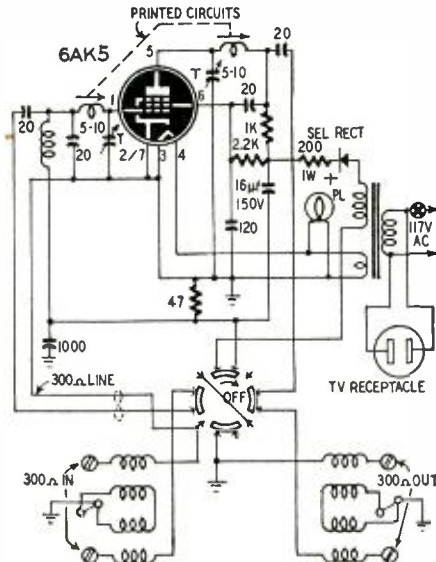

Fig. 5—The Standard B-50 is unusual.

sets having isolation transformers or to ground on transformerless sets.

The B-50 is housed in a brown, hammer-tone-finished metal cabinet 8 inches wide, 4 1/2 inches high, and 5 inches deep. Its illuminated slide-rule dial is calibrated for channels 2 through 13.

**Super Sonic IT4**

This is the only booster which features continuous tuning over both TV bands and the FM band without switching. The tuning elements are spiral-wound coils which are rotated by the tuning control. As the coils rotate, spring sliders move along them to short out turns as the frequency is raised. Both coils are resonated by the com-

**Facts about boosters**

Some boosters may have lots of gain and comparatively narrow bandwidth while others may have wide bandwidth and not so much gain. The booster to be selected will depend on the receiving location. If usable signals are obtained without a booster, a wide-band, low-gain unit will probably give the best results because it will amplify the signal enough to produce an acceptable picture without loss of definition. In locations where the signal is so weak that the sound is received without the picture, or the picture is full of snow and so weak that almost any interference will show in the picture, a high-gain, narrow-band booster may be the best bet. The narrow bandwidth will aid in attenuating interference while bringing the signal up to an acceptable

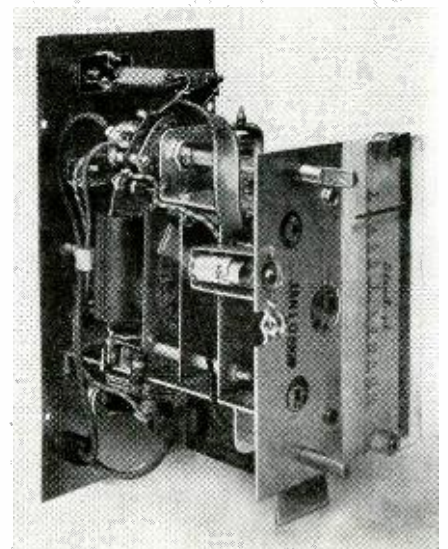

Fig. 6—The B-50 printed circuits can be seen to the left of the pilot light.

level. The loss in definition due to side-band clipping will not be too objectionable in instances where the picture is not acceptable without a booster.

One manufacturer pointed out that most boosters have switches which bypass the lead-in around the booster when it is off. These switches result in a mismatch which may result in con-

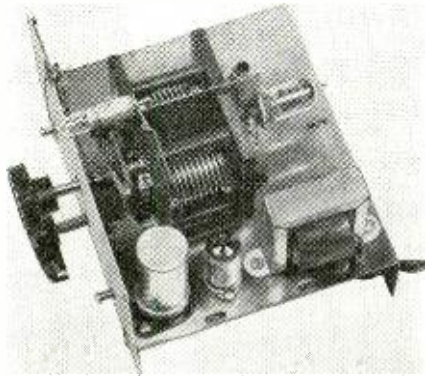
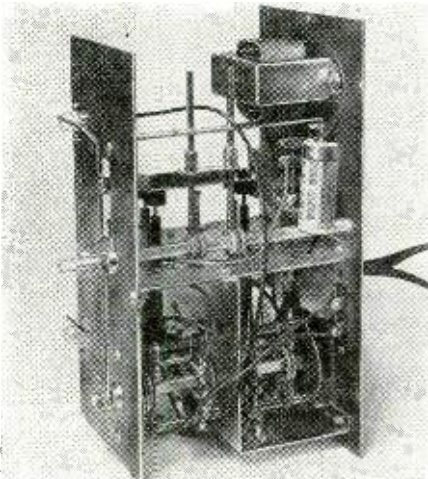

Fig. 7—Spiral-inductance tuned booster.

siderable insertion loss when the booster is off. Therefore, in comparing boosters, the operation should be carried out by comparing the picture with the antenna connected directly to the TV receiver with that obtained with the booster operating between the antenna and set.

In the instruction sheets, manufacturers almost universally recommend the following steps in obtaining optimum performance from a booster:

1. The length of line between the set and booster—including the line from the antenna terminals to the tuner in the set—is critical. In most instances, the over-all length of the line should be a multiple of 2 feet. Try different lengths of line for the best picture on the weakest high-band station.
2. The input and output leads should not cross nor should they be closer than 6 inches apart.
3. Try reversing the leads to the output posts on the booster.
4. Tune the set for the best sound.



Two boosters use this smooth tuning system. Backlash is prevented by attaching the pointer direct to the tuning slugs.

# Spot-wobble Improves TV

By RALPH W. HALLOWS

RECENTLY I enjoyed two hours of the most pleasing television that I have yet seen. The set was one of those giant affairs with a 20-inch picture tube. With some friends who had come with me, I sat about 7 feet from the screen.

"Far too close," say the experts. "The proper viewing distance for a screen that size is about 12 feet. You don't give the set a chance when you sit so close. The quality of the image is ruined by the horizontal lines."

The facts are that we *did* sit at about half the "proper" distance, and there was not the faintest trace of lines in the image.

The reception was so pleasing because we could view such a large screen at close quarters. If you obey the experts and watch the screen of a standard television set from what they say is the correct distance, two things happen: the first is that you are no longer actively conscious of the lines; the second is that in losing the lines by increasing the viewing distance, you also lose some of the detail of the image. If the screen can be made free from these lines, a short-range view of the image is very pleasing.

The process of freeing the set from lines is so simple that I have been taking running kicks at myself for not having thought of it first. Called spot-wobble, the name describes what it does. Instead of moving in straight lines from side to side of the screen, the scanning spot is given an up-and-down movement of very small amplitude but of very high frequency.

As we took our places, I was given a small box connected to the television by a length of cable. An ordinary toggle switch was mounted on the box. In the "on" position, the line removal circuit was in action; turning the switch to "off" cut it out. At 7 feet, the lines are usually very marked on a 20-inch screen, especially in the near-white parts of the image. With the switch at "off", they certainly were; but the lines disappeared completely when the switch was turned to "on".

It was particularly interesting to throw the spot-wobbler in and out of action when the image had such things as clouds in the sky, light-colored backgrounds, or open books, letters, and so on in which the lines are usually most evident. The familiar dark lines show up most when the viewing distance is short and the wobbler is out of action, but they disappear completely the instant it is cut in.

To add spot-wobble to a receiver, nothing is needed but the simple ar-

angement shown in the diagram. I don't give circuit constants—or even circuits in detail—first because I had no opportunity to dig into the bowels of the receiver and note the values of the parts; and second, because the setup is so simple that nearly every reader of RADIO-ELECTRONICS can work out the details himself. I can guarantee the correctness of the general layout shown. The circuit requires no sync, but oscillates independently and requires only one additional tube.

In the British system, there are 405 scanning lines and 25 frames a second. A 10-mc signal was super-imposed on the vertical deflecting field to give the line about 1,000 wobbles per line. In the American system with 525 lines and 30 frames per second, the oscillator frequency would have to be about 15 mc to give a similar number of spot-wobbles per line.

Two points are very important. First, it is necessary to have a switch to cut the wobbler in and out of action. This is required because the set should be focused with the wobbler off. Second, it is most important to be able to control the amplitude of the wobble. If it is too great, there is distortion and a loss of vertical definition. If it is too small, it will not eliminate the lines.

This system is especially noteworthy

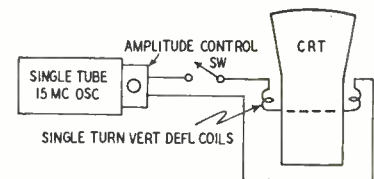

Spot-wobble can be applied very easily.

because it is applied to the output stages of the receiver. If it were applied at the transmitter, it would require a considerable increase in the modulation frequencies. If it were applied to the r.f. or i.f. circuits of the receiver, it would require much greater passbands. As it is, it can be applied to *any* receiver.

The British patent covering this remarkable improvement in TV reception dates back to 1938. It is the property of Cintel Ltd., the J. Arthur Fank subsidiary which is concerned with the development of large-screen television for use in movie theaters. For the demonstration described I am indebted to the research department of the BBC, which is now exploring the possibilities of spot-wobble in black-white, color and stereoscopic television.

# Anything Can Happen in TELEVISION

**W**AY back, somewhere around 1923, when the public mind seethed with the mystery and wonder of radio broadcasting, there were some amazingly weird tales about the new entertainment miracle. For example, there was the chap who claimed he could hear broadcast music with his teeth. Seems that he had a silver inlay in one of his bicuspid adjacent to a gold crown protecting the remnants of a molar. These two dissimilar metals in a slightly acid solution, the saliva, generated a small voltage. With the aid of this "cell" he was able to "hear" stations. It never was made clear how he managed to get the sound—probably a loose filling vibrating at an audio rate. There was also the story of the woman who lived practically next door to a broadcast station. Nothing wrong with that except that her stove gave out with music and commercials. She didn't mind since it didn't interfere with her cooking. The only thing she couldn't figure out was how to tune the darn thing.

We don't make any claim whatsoever that these two stories are true. They might have been, for all we know, but you'll have to do what most everybody did . . . believe them or leave them. However, now that television has become everybody's fancy, some very unusual tales have started cropping up. Like the story of channel 2 and the vase.

The story begins over at Pilot Radio

\* Instructor—Pierce School of Radio & Television, New York, N. Y.



Concealed front end in a flower vase?

By **MARTIN CLIFFORD\***

Corporation where our good friend Ed Wollman, service manager, had just received an unusual complaint. Some woman, resident in the lush Park Avenue section of Manhattan, was annoyed that her receiver could get all channels—all, that is, except channel 2. Ed rushed over with the woman's plaint, "I wuz robbed," ringing in his ears.

**TEN DOLLARS**

Will be paid by **RADIO-ELECTRONICS** for each authenticated report of freak television reception, similar to those described here. Cases must be original and interesting.

Send entries to:

**UNUSUAL TELEVISION TROUBLES**  
c/o **RADIO-ELECTRONICS**  
25 West Broadway, New York 7, N. Y.

When he arrived, he found the woman watching . . . you guessed it . . . channel 2. Ed could have gone back to the factory and grabbed himself some credit for quickly fixing a toughie, but not Ed. He's intellectually honest, and what's more important, curious. He questioned the customer. All he could find out was that channel 2 had come on by itself. Ed decided to investigate. He turned the receiver catty-corner so that he could peek in at the inside works, being very careful in the meantime to remove a very heavy, decorative vase from the top of the receiver. As he did so, he noticed that channel 2 had disappeared. Just like that. He put the vase back on the receiver, and channel 2 came right back. On again, off again. It happened every time. Ed took the flowers out of the vase. They made absolutely no difference. All that set wanted was to have the vase sitting topside in order to get channel 2. The other channels came in the way they were supposed to, vase or no vase. Ed was a wee bit perturbed. How would you like to go back to your boss and tell him that, in the future, a flower vase would have to become part of a TV front end, and should be shipped with all new receivers?

Ed did the only thing he could do. He examined the vase. Maybe there was a concealed front end in it? At the bottom of the vase he found a big lead ring used as a support and weight to keep the top-heavy vase from killing itself. Ed had found the answer. The metal ring was picking up channel 2 and re-radiating it.

You have every right to ask "why", and here's the best answer we've been able to think of, to date. Sometime ago we were measuring the Q of various broadcast coils on a Boonton Q-Meter. By using polyiron slugs and polyiron shells and Litz wire on a low-loss form, we were able to get a Q of about 200. We happened to have a metal ring from an old cable, and just out of wild impulsiveness decided to check the ring for its Q. It was fantastic. That old metal ring had a self-resonant frequency at umpteen-umpteen megacycles and its Q was so great that the meter needle tried to climb out of the case.

Now think of that ring in the bottom of the vase. It was probably self-resonant to channel 2, and with a very high Q (hence high gain) it was re-radiating channel 2 with a vast amount of enthusiasm. We don't say this is the correct solution, but if you've got a better one, we'd certainly like to hear it.

The next case we ran into was the story of the disappearing channel 4. This story comes from Al Friedman, television instructor at the Pierce School of Radio & Television, New York City. Al has a hobby. No, not television. He gets enough of that all day long. Al is wild about antennas, especially TV antennas. Don't ask us why. It's one of those queer foibles that any of us can have.

One of Al's customers, a woman for whom he had done some very fancy indoor antenna work, called him on the phone with a very curious complaint. She wasn't angry, just sort of wondering. Was it customary, she wanted to know, for channel 4 to go off the air every day, promptly at four o'clock. Right in the middle of a program, too! And didn't Al think it was sort of strange, especially when no other receiver in the building did just that?

Al went over that set with a finetooth comb. He also used test instruments. There was nothing wrong. The receiver was perfect and so was the

**RADIO-ELECTRONICS for**

special fixed indoor antenna he had installed. He uprooted the antenna and it went into every conceivable location and into every possible position in that apartment. It worked best where he had placed it originally, with this one very sad exception. Promptly at 4 p.m., channel 4 took off like a frightened rabbit. Disappeared. Vanished.

The mystery began to dissolve when Al happened to look out of the window. It seems that the occupant of the apartment immediately across the court had raised her venetian blinds. This fact, although it seemed to have no connection with the case, stuck in Al's mind, and what is better, bothered him. Was it a coincidence that the blinds were raised at the same time that channel 4 had disappeared? He decided to investigate. Sure enough, next day, at exactly the same time the



No venetian blinds, no channel 4 pix.

blinds were raised, channel 4 disappeared.

Al made an arrangement with the owner of the receiver. "I want you to stand by the window," he told her, "and raise your hand every time channel 4 vanishes." Then he trotted over to the apartment across the way, and got permission from the astounded housewife to raise and lower one of her venetian blinds. That was it, sure enough. His customer waved her hand every time he re-adjusted the blinds. The blind was down all day to keep the sun off the furniture and rug. It was raised at 4 p.m. every day by a very methodical housewife, in order to get more light and air into the apartment.

And now, what is the solution to all this? Simply that the venetian blinds were made of aluminum and were reflecting channel 4 with sufficient gusto to enable it to be picked up. This explanation may be too simple for complicated minds, but there it is.

There are quite a number of things which we must take for granted, otherwise life would become much too complicated. For example, we confidently expect the sun to rise every morning. When we walk down a street, we certainly expect buildings or other

large structures to remain the way they are, and not to change their shapes. And what has all this philosophical meandering got to do with television? Let's investigate the mystery of the increasing and decreasing television signal, told by a chap who prefers to remain anonymous.

The trouble was very simple. The owner of the receiver was very irritated. "I wish," he told the serviceman, "I wish that the operators of channel 11 would make up their minds. Sometimes I get them swell and sometimes they don't come in at all. What've they got? Women engineers, huh?" As events proved, this last remark showed a definite phobia about women and should be disregarded.

It was just as the customer had said. Sometimes channel 11 came in so strongly that the contrast control had to be backed way down. And at other times? Well, channel 11 was there if you had a good imagination and 20-20 vision. And, as usual, the \$64 question—why? Why should channel 11, normally well-behaved and self-respecting, behave in such a flipperty-gibberty fashion? Especially when the receiver was in top-notch operating condition and the antenna installation could be used as a model for all technicians. Nevertheless, the technician in this case gave the roof antenna a thorough checking over. Nothing wrong there, he decided, shoving one foot on a roof ledge and gazing moodily out into space in the general direction of the TV station. He noticed a gas tank somewhat in his line of vision, but since the tank was too small to obstruct the signal, paid little attention to it.

Our hero didn't get the set fixed that day. Nor the next. Nor the next. Finally, in desperation he decided to go in for a completely new type of antenna. He had to do something. During his meanderings around the roof, he noted that the gas tank had apparently doubled its size! This was too much! Now he was seeing things. Perhaps it would be better to admit defeat, give the customer back his money, and go into a nice safe business, like plumbing maybe. Anything, anything would be better than this. Imagine a gas tank increasing in size! Perhaps the best thing to do would be to sit down and wait patiently for the little man with the white jacket.

It was somewhat in the "I know I'm crazy for doing this, but can't help it" spirit that he invested a nickel and called the gas company. "I know this may sound silly to you, but your gas tank has changed size." The gas company wasn't surprised. Seems they had been doing it for a long time. The manager of the gas company thought it was funny. "We regularly get calls about it. Our tanks move up and down, depending on the volume of gas we have stored. Lots of gas . . . big tank. Little gas . . . small tank. Clever, huh?"

Our hero didn't think so. Short of blowing up the gas tank there was nothing he could do. On successive times during the day, he and the set

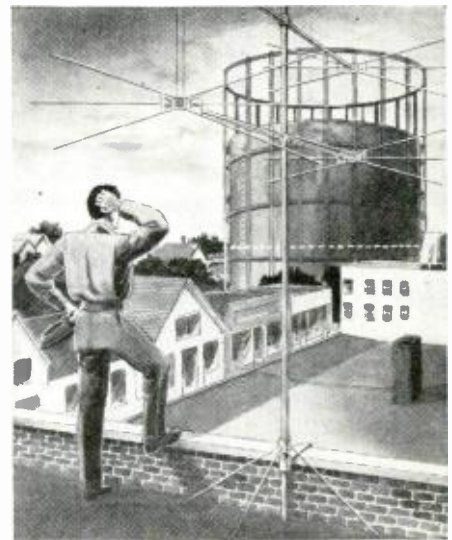

Dotted line shows minimum tank height.

owner went up on the roof to watch a tank that couldn't make its mind up as to what size to be. Oh, yes. The reason why channel 11 did or did not come in? Simple! When the tank was big enough, it blocked the signal. When the tank was small, the unobstructed signal sped through the air with the greatest of ease. What is it that textbooks say about high-frequency r.f.? Quasi-optical? Maybe those books could stand a re-reading.

If you've stayed with us this far, you're in a good position to solve the problem in this last story. Complaint? Set works fine for three, maybe four, days, and then about half of the channels become so weak and emaciated that it's nothing short of pitiful. And then, apparently shaking itself out of the doldrums, the set decides to work swell for several days. This would be fine, if it would only last, but it doesn't. The set sulks, and snow or just a plain raster takes over where good pix are supposed to be. Very discouraging. What would you do, if every check and test of which you know proves conclusively that the set is working right and that the antenna installation is a dream. Go into some other business, maybe, or sniff around to see if something unusual is in the wind. The text book don't give all the answers, you know.

The technician in this case found the answer. Not too quickly, mind you, but he found it. Seems that the set owner lived near a large pier. Once a week a big ship would come in and tie up at said pier. That big mass of iron and steel soaked up TV signals like a sponge that hasn't had a drink for a month. If you want to go "engineering" on us, you can say that the ship disturbed the normal field-strength intensity pattern, that it radiated a signal whose angle was out of phase with the original signal, thus causing cancellation at the antenna. We like our own answer because every time that ship took off for parts unknown, that little receiver worked right.

# Master Television Antenna Systems

**Final answer to multiple-dwelling antenna problems**

**By IRA KAMEN\***

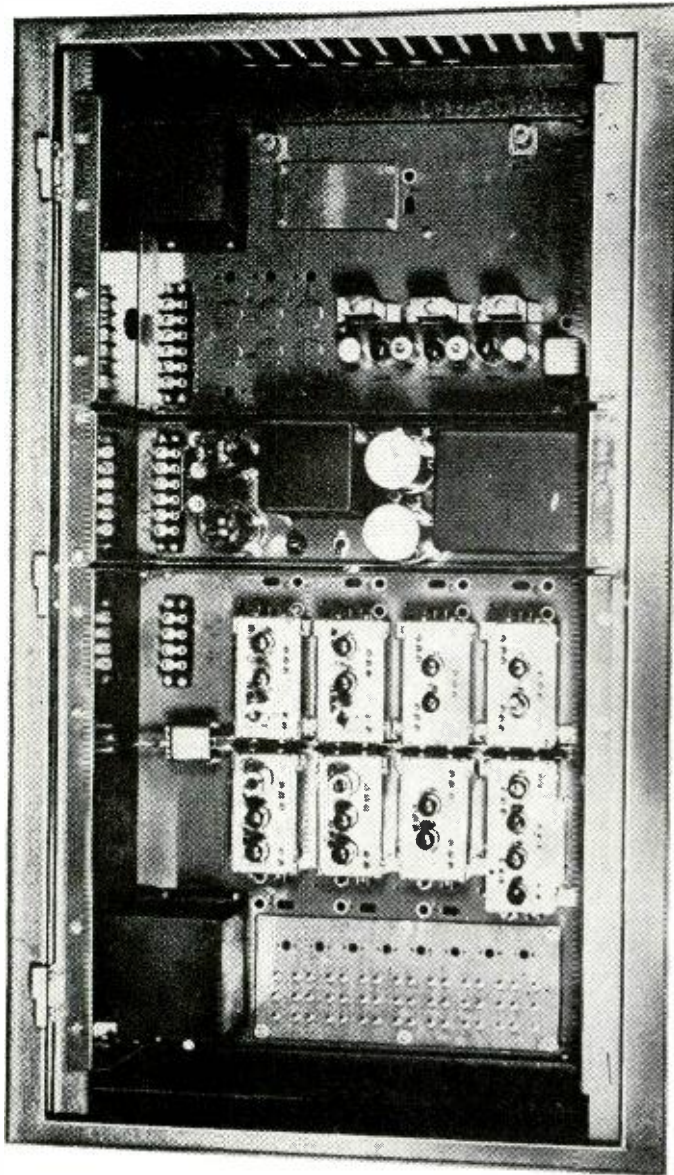

Fig. 1—In this installation an amplifier is used for each channel.

**T**ELEVISION signals are quasi-optical (having qualities similar to light) and cannot be made to pass through steel structures in spite of the best engineering skills of the greatest sales and advertising managers in the field. For this reason, master television antenna systems in fire-proof (steel-wall) buildings are necessary when a large number of TV sets are to be installed. A master antenna system must solve five problems in urban installations. To demonstrate these problems, the author will review a specific installation of the RCA Antnaplex master antenna system at the

\*Manager, Television Dept., Commercial Radio Sound Corp., N.Y.C.

Hotel Commodore in New York City.

The Hotel Commodore is at 42nd Street and Lexington Avenue, and six New York TV stations are received from six different directions. Therefore, the first problem is to receive ghost-free signals from each of the stations. Tests were made on the roof of the Commodore with an individual directional array for each television channel. The six locations were found, and three-, four-, or six-element Yagis installed. The locations were found by two men and a good 400-line-definition television receiver. Tests began in the most practical locations for a television antenna, but sometimes the best picture can be found only in less desirable

parts of the roof. The search for pictures does not stop until a good signal free from ghosts and interference is found. Reflected signals from solid steel buildings are dependable, but reflected signals from palisades, cliffs, and hills cannot be considered a stable source of signal. The presence of ice and snow on these earth-type structures may completely change the character of the reflected signals.

The second problem is to get strong signals of not less than 3,000 microvolts for each television receiver in the system to overcome or swamp any signals from external sources.

An amplifier shown in Fig. 1 with a pretuned booster for each television channel is installed. Antennas for each channel feed their signals to the amplifier unit, and the individual pretuned boosters increase the signal level to approximately 1 volt for each channel. A mixer network in the amplifier combines the outputs of the six boosters so they can be distributed over a single cable.

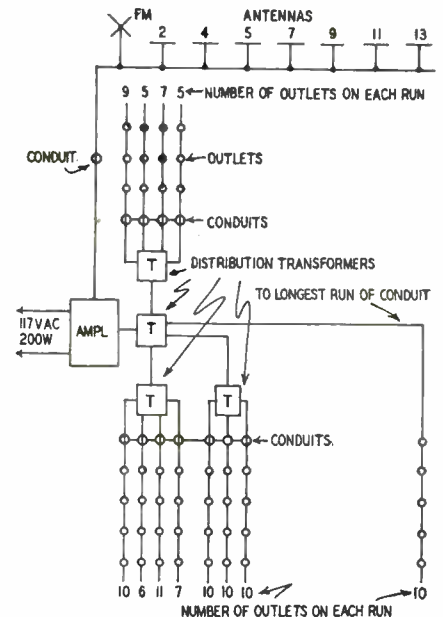

Fig. 2—A typical distribution system.



Distribution of the television signals to feed many outlets is the third problem. In the Hotel Commodore installation, facilities were desired for television in both public places as well as in private rooms.

The amplifier output is fed through a 72-ohm coaxial cable to an r.f. (50-220 mc) distribution transformer

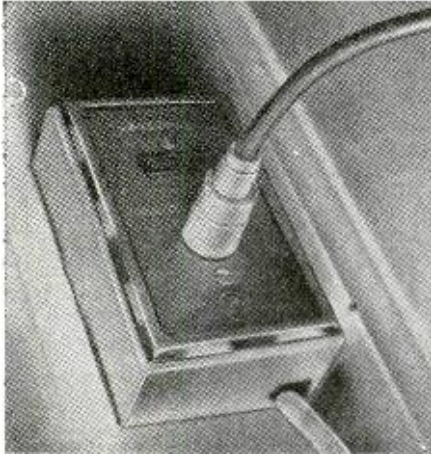

Fig. 3—Appearance of receiver outlet.

which provides four 72-ohm outputs from its one 72-ohm input. The four outputs of the first distribution transformer can then be fed to four other transformers which in turn can feed a total of 16 outlets. This method can be expanded to many more outlets.

When all the outlets can be one next to the other, the best method of distribution is to tap the coaxial lines from the first distribution transformer. It is also possible to combine the two methods of distribution when the layout of the building is suitable. Fig. 2 shows how this is done. Notice that the longest runs of cable go directly from the first distribution transformer, while shorter runs can be distributed further.

Radiation from the local oscillator of the front end of the television receiver is the fourth problem. Television receivers in New York are tuned to channels 2, 4, 5, 7, 9, 11, and 13 and their local oscillators radiate to some extent on channels 5, 11, and 13.

The outlets on either the transformer or tap distribution system are isolated from each other partly by resistive networks within the outlet and partly by attenuation in the coaxial cable between the outlets. The coaxial cable losses may be appreciable in the transformer distribution method. In the Hotel Commodore installation there is more than 500 feet between some of the outlets, adding 20 db to the loss in the system.

Connecting all types of television receivers to the outlets without altering the outlet or the television receiver is the last problem.

A coaxial fitting on the front plate of the outlet (Fig. 3) offers the television signal at an impedance of approximately 72 ohms, which can be connected directly to the input of nearly all the television receivers which use Inductuners, elevator transformers, or

other input coil arrangements which allow direct connection to coaxial cable. For early model television receivers which require a balanced input, there is a special transformer which converts the unbalanced coaxial signals to signals balanced to ground which match a 300-ohm input.

In either system, it is important that the coaxial cable be terminated with the proper impedance. Fig. 4 shows the receiver outlet circuit for both types. In the transformer system, each outlet provides the proper 50- or 72-ohm impedance to the line; but in the tap system, only the last outlet on the line has the required terminal impedance, and all other outlets present a high impedance to the line. Both outlets have a high-pass filter (40-mc cutoff). AM and shortwave signals are taken directly from the coaxial cable through a 1,000-ohm series resistance which prevents the AM receiver from loading the cable.

FM may be added to the master antenna system, and an additional channel 13 from Newark may also be added if it can be received with adequate signal strength. All Antenaplex amplifiers

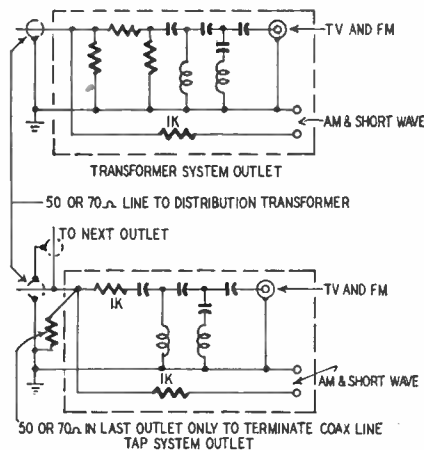
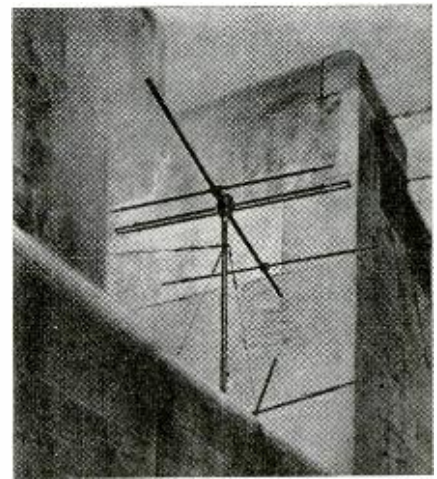

Fig. 4—Networks at receiver outlets.

are designed for continuous operation of the tubes.

Large dealer establishments and department stores can use similar systems to solve their demonstration prob-



One Hotel Commodore antenna location.

lems, enabling all receivers to operate under common conditions. The customer can make a fair analysis of all the television receivers and pick the one which performs to his liking. At present, many customers make unfair comparisons between receivers operating from separate and often quite different antennas.

While new construction jobs are confined to the electrical contractors in most areas, the servicing dealer and television installation companies can install master systems in existing buildings.

In some localities the dealer will aid in financing antenna system installations to open new markets for television receivers.

Business organizations who finance installations of master antenna systems in buildings operate like telephone companies and make an initial connection charge and a monthly service charge to the tenants in the building. Systems for this type of financing are usually installed so that the antenna service can be disconnected without entering the tenant's apartment.

The cost of installing a system depends on the quality of local reception, the number of outlets and their location, and the accessibility of conduits and shaftways in the building.

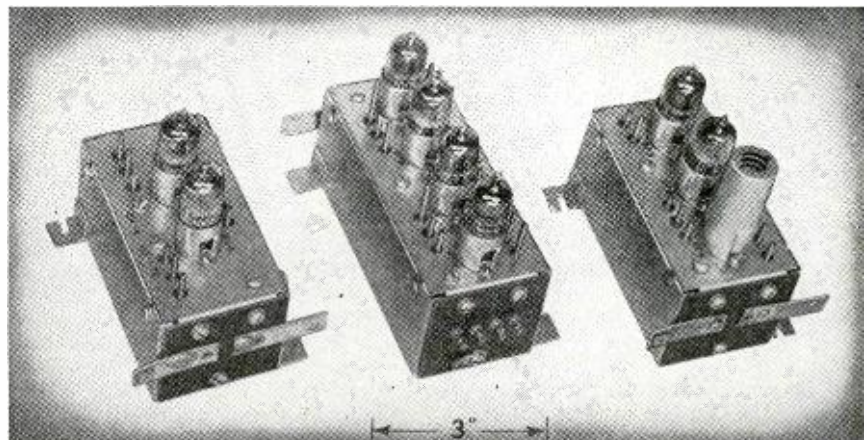

Left to right—Amplifier for channels 2-6, FM amplifier, unit for channels 7-13.

# A De Luxe Televiser

## Part V—Alignment and adjustments of the video and the sound i.f.'s

By

CHARLES A. VACCARO

IF YOU have constructed the deluxe televiser described in the January, February, and March issues, you are now ready to align the video and sound i.f. strips. Refer to the complete schematic in Fig. 17 (March issue) for the frequencies of the coils and transformers and for the location of the tuning slugs.

There are a number of preliminary adjustments which must be made before alignment is begun. The table gives settings for the various controls, the resistance being measured between the arm (center terminal) and one of the numbered outside terminals or to another point in the circuit.

After making the adjustments, turn the adjusting screws approximately halfway into each end of the automatic sync discriminator transformer. Screw the core of the width control in approximately halfway. Set the D.S.C.-A.S.C. switch in the A.S.C. position. Now install the picture tube and its socket. *Always hold or support the tube by the cone. Never allow any pressure to be exerted on its thin neck.* Adjust the deflection coils until the assembly is tight against the cone and adjust its mounting so the grounding springs are bearing lightly on the external conductive coating of the tube.

Adjust the mountings so the focus coil is about  $\frac{1}{8}$  to  $\frac{1}{4}$  inch from the deflection coil and centered about the neck of the tube. If you are using a tube that requires an ion trap, install the trap so the magnets are over the flags which can be seen through the neck of the tube. The large magnet must be toward the base of the tube. When a 10FP4 or 12KP4 is used, the ion trap is not required. Connect all cables, plug the linecord into a convenient outlet and turn the chassis on its side so that it rests on the high-voltage supply box. Put a book between the mounting ring and table if there is any tendency toward wobbling.

Turn the TV-OFF-RADIO switch to TV position and measure the voltages between 225- and 400-volt power supply terminals and receiver chassis. DO NOT measure to the power supply chassis as these values will be different. If there is much variation from 225 and 400 volts, check to see that all tubes are in and review the power supply data in the March issue if trouble is encountered.

Make sure that the line voltage is

about normal (117 volts) before making any of these changes. The closer the subject voltages are to 225 and 400, the easier it will be to compare circuit voltages on the schematics.

Now there should be some indication of a raster on the screen. If an aluminumized screen tube such as the 10FP4 is used, vary the focus control and adjust the focus coil to obtain fine horizontal lines focused as evenly as possible over the entire raster. If a tube such as the 10BP4 is used, move the ion trap back and forth and from side to side until a position is found where the intensity of the raster is maximum without being shadowed on either side. Re-adjust the focus coil and focus control if necessary to obtain evenly focused horizontal lines. The raster can now be centered by tilting the focus coil. Finish the horizontal centering by adjusting the horizontal centering control on the rear of the chassis.

### Aligning the video i.f.

If you yielded to the temptation of seeing a station come in, turn the channel selector switch to the blank position between channels 6 and 7.

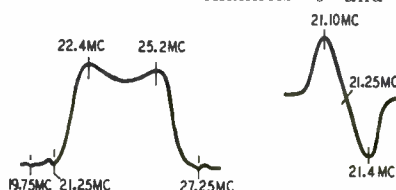

Fig. 20, left—Response for video i.f.  
Fig. 21, right—Response for sound i.f.

This cuts off the oscillator and prevents r.f. from coming through the front end.

Turn the adjusting screws approximately three-fourths of the way into the 19.75- and 21.25-mc traps and the screws on the other coils all the way out. *The video i.f. adjustments are on the bottom and the trap adjustments on the top of the strip.* Now connect an oscilloscope, output meter, or a v.t.v.m. between the junction of the 6AC7 video peaking coils and ground. Connect a .05- $\mu$ f capacitor and 10,000-ohm resistor in series with the inner conductor of a low-capacitance shielded cable if the indicator does not already incorporate a capacitor.

Connect the signal generator to the grid of the mixer and to chassis ground using approximately 200  $\mu$ f in series with the hot r.f. lead.

Turn on the internal modulation. If it is adjustable, turn it up to about 50%. Set the dial to 25.0 mc and increase the output until a slight increase is noted on the output indicator. If there is no increase turn up the contrast control until wide black and white bars appear across the raster. Screw in the core of the last i.f. coil, tuning for a maximum indication. Note occasionally if the black and white bars are getting too black. When the entire raster is black, it indicates the video amplifier and possibly the i.f. amplifiers are being overloaded and the signal generator output and the contrast control, or both, should be reduced. Adjust the signal generator output and the contrast control when necessary so the black bars appear slightly gray or about the same width as the white bars.

After adjusting the 25.0-mc coil, set the signal generator at 25.3 mc and adjust the core of the next coil forward to give a maximum output indication. Repeat with the next stages working toward the mixer, retuning the signal generator and tuning the coils to maximum output at the frequencies indicated on the schematic.

Now set the generator to 21.25 mc and advance its output control and the contrast control of the receiver until a good deflection is noted on the indicator. Adjust the top core on the first i.f. coil to obtain a minimum deflection. Still at this setting, adjust the core in the cathode trap to a further minimum. It may be necessary to move the signal generator to the grid of the first or second i.f. amplifier to see a good indication of a minimum response from the cathode trap.

Set the generator to 19.75 mc and reconnect it to the grid of the mixer if it was changed in the last step. Adjust the core of the 19.75-mc trap to minimum and repeat the procedure for the 27.25-mc trap. There being some interaction between cores on the same forms, touch up the adjustments of the video i.f. coils by repeating the alignment and making sure that each is tuned for maximum output at its proper frequency. *Make sure that this section of the alignment is followed closely, as a poor job done at this stage will impair the quality of the final picture.* The alignment can be checked by rotating the generator dial slowly from 18 to 28 mc and comparing the

output indications with the response curve in Fig. 20.

The output should show an increase following the upward slope of the curve and remain fairly flat across the top and decrease as the slope decreases at the right side. A closer comparison can be made by plotting the output indications versus the frequency at several settings of the frequency dial. If a large difference is noted in the curves, check the values of the grid and plate resistors and change any that are off more than 5%. If any of the cores on the i.f. strip do not have enough range to tune to both sides of the maximum point, remove them and check them against the dimensions given in Fig. 4.

### Aligning the sound i.f.

Set the signal generator frequency to 21.25 mc and check that the *minimum* response of the *video* i.f. amplifiers at 21.25 mc agrees with this setting. Now, without touching the signal generator, adjust the *audio* i.f. transformer cores to obtain maximum output from the speaker. This can be done by ear, using a low level of audio or connecting the indicator previously used across the 6V6 audio amplifier. Now adjust the bottom (primary) core of the discriminator transformer for maximum output. The peak will be broad. Next adjust the top (secondary) core of the transformer to obtain a null. When the null is found, the amplitude modulation can be cancelled out completely with further careful adjustment. Detune this core about one quarter turn or until sound is heard again and readjust the other cores again for maximum sound from the speaker. Then retune the top core of the discriminator transformer to the null position or minimum sound. Now tune the generator first to approximately 21.35 mc and then to 21.15 mc, noting the audio output. The output should be as nearly equal as possible at these two points. (See Fig. 21.) Touching up of the audio i.f. transformer and discriminator primary adjustments will help to make these equal.

### Additional adjustments

Remove the output indicator and the signal generator and we will proceed to bring in a picture. The antenna should be temporarily placed so that it is about broadside to the direction of the transmitters and should be connected to the receiver with 300-ohm line.

Turn the intensity control to obtain a good visible raster and turn the contrast control about halfway. Now switch the station selector switch to a channel where the station is known to be on the air. If the coils were spread to the dimensions indicated in Fig. 14 and the wiring of the front end was followed exactly, some sort of signal or picture should be seen on the screen.

If nothing is seen, turn the contrast control up higher and repeat the switching. If the raster goes black, it is an indication of excessive signal and the contrast control setting should be reduced.

If the preliminary adjustments were made as outlined earlier, you probably have a pattern on the picture tube screen with black and white diagonal or nearly horizontal bars or lines. Adjust the primary core of the sync discriminator transformer that protrudes from the rear of the chassis. As the adjustment is brought closer to resonance, the diagonal lines will be

### Preliminary Adjustments for Aligning.

Control	Setting
Intensity	100,000 ohms to No. 1
Contrast	400,000 ohms to ground
Volume	One half rotation
Vert. hold	140,000 ohms to No. 1
Tone	One half rotation
Horiz. Lin. No. 1	60,000 ohms to pin No. 3 or 6 of 6AS7-G
Horiz. Lin. No. 2	82,000 ohms to No. 1
Horiz. centering	6 ohms to ground
Focus	200 ohms to No. 3
D.S.C. Horiz. hold	85,000 ohms to No. 3
A.S.C. Horiz. hold	38,000 ohms to pin No. 5 of 6F6 osc.
Vert. Lin. No. 1	7,000 ohms to pin No. 8 of 6V6 vert. output
Vert. Lin. No. 2	5,300 ohms to pin No. 8 of 6V6 vert. output
Height	950,000 ohms to No. 3

come more and more vertical until the picture becomes synchronized. Adjust the vertical hold control on the front panel if the picture is slipping up or down. At this point don't worry if the sound cannot be found or the picture quality is poor. Turn the contrast control down until retrace lines are visible and then advance it to a point just beyond that at which the white retrace lines disappear.

If a test pattern is being received well enough, the linearity adjustments of the receiver can be made at this time. Return to this after the r.f. alignment if the test pattern cannot be received well enough.

Assuming that the controls were preset as outlined in the table, very little additional adjustment will be required. The vertical linearity control No. 1 expands the upper and contracts the lower section of the test pattern when turned in one direction and vice versa in the other direction. Vertical linearity control No. 2 mainly affects the top edge of the picture. Moving past the correct setting in one direction will result in squeezing of the top few lines and in the opposite direction of the control they will be spread apart. The height control and the vertical linearity control affect each other slightly, so it may be necessary to readjust the vertical linearity No. 1 and then the vertical linearity No. 2 control if the height control is

changed. Adjust these so the top and bottom sections of the test pattern are equal in size. The horizontal linearity and width controls affect the picture in the horizontal direction and are a little more critical than the vertical controls. Adjust the horizontal linearity control No. 1 until the picture is as wide as possible without squeezed or expanded sections (vertical bars lighter or darker than the rest of the raster), and until the test-pattern wedges on both sides are the same size. Repeat with control No. 2 which keeps the lighter or darker bars out of the left side of the raster. Adjust the width control by screwing in the core to increase the width of the raster.

The direct sync control (d.s.c.) system should be adjusted before the r.f. alignment is started. Temporarily short out the tuned circuit in the cathode of the horizontal multivibrator with a jumper across the coil. Switch the A.S.C.-D.S.C. sync control switch to d.s.c. position and, if necessary, readjust the d.s.c. horizontal hold control (on the back panel) to bring the picture back into horizontal synchronization. (Note that when the switch is thrown, it will be necessary to readjust the focus and contrast controls slightly as the plate supply currents from the power supply have been decreased.) adjust this horizontal hold control accurately and make sure the picture stays synchronized in this position.

Lack of low-frequency response may make it unstable because the front end is not yet aligned. It can be made more stable by trying a different position of the fine-tuning control. When you are sure that no better adjustment of the hold control can be made, remove the jumper from across the tuned circuit and adjust the core of the coil until the picture is again synchronized and the test pattern is fully on the screen. Do not touch the horizontal hold control while making the core adjustment. Once this core is set it usually requires no further adjustment during the alignment procedure.

Proper alignment of the video i.f. stages is extremely important for good pictures. The details of the picture are contained in the higher frequencies of the picture signal, and if there is any attenuation of these frequencies, the picture will have poor horizontal detail, as can be seen on a test pattern.

If the sound trap is not adjusted correctly, the sound signals can mar the picture. The sound signal will beat with the picture signal, and if the beat frequency is less than 1 mc, horizontal bars may appear in the picture.

Another type of sound interference is caused by the FM signal being converted to an AM signal by the sloping response of the video i.f. If this occurs, the sound signal is coupled to the video amplifier and will also appear as bars in the picture.

# Voltage Multipliers in Television

Basic multiplying circuits that are often found in TV receivers

By C. W. PALMER

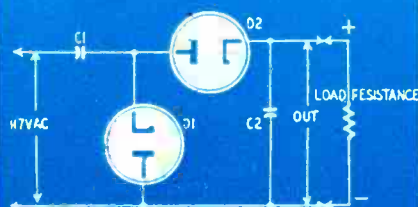

Fig. 1—The simplest form of doubler.

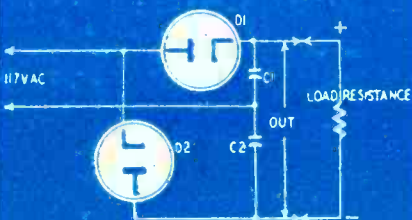

Fig. 2—Widely-used full-wave doubler.

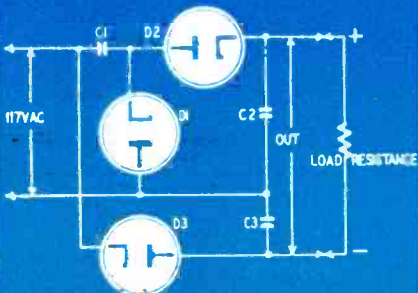

Fig. 3—Another diode makes a tripler.

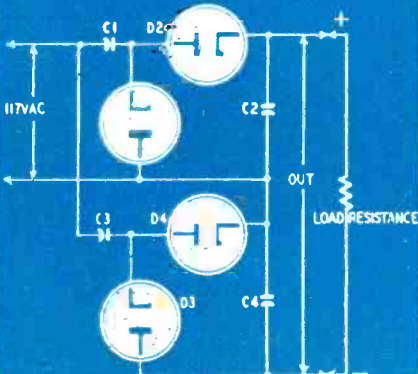

Fig. 4—Two doublers make quadrupler.

**K**NOwn for many years, voltage multiplying circuits have been used in a variety of ways to step up and rectify line voltage without using power transformers. The midget radio receiver brought voltage doublers into wide use.

The voltage doubler, tripler, and quadrupler have now found new utility in television receivers where space and weight are important considerations. Voltage multipliers are employed in both low- and high-voltage supplies in some of the latest TV sets.

Because of this trend, it will be of value to the radio and television technician to review the basic principles of these multipliers and to look at a few of the current TV receiver circuits in which they are used.

The simplest form of voltage doubler and the one most widely used consists of two diodes and two capacitors C1 and C2 as shown in Fig. 1. In this circuit, when the voltage from the a.c. line is of such polarity that the rectifier D1 plate is positive, current passes through this rectifier and capacitor C1 is charged to a voltage equal to the peak voltage of the a.c. line (1.4 times the r.m.s. voltage) minus the voltage drop through the tube D1. During this time, rectifier D2 is not functioning, as its plate is negative.

When the polarity of the a.c. line reverses at the end of the half cycle, the voltage on C1 is added to the line voltage and the total is applied to rectifier D2, thus charging capacitor C2. This capacitor, being connected to the load, immediately starts discharging through the load, so that its charge never quite reaches the peak voltage of the line plus capacitor C1 voltage. For this reason, the voltage impressed on the load is not quite twice the peak a.c. line voltage.

The larger the capacitance of C1 and C2, the nearer this voltage approaches twice the peak line voltage. On 60-cycle lines, the capacitors should be not less than 16  $\mu$ f.

This circuit has all the characteristics of a half-wave rectifier of standard

design except that the regulation (the change in output voltage with a change in load) is not as good. This poor regulation is characteristic of voltage multipliers and is one of the limiting factors of this type of circuit. In circuits that are sensitive to voltage change, some form of voltage regulation must be added to compensate for the poor regulation.

A voltage doubler popular in midget radio sets is the full-wave doubler shown in Fig. 2. Here diode D1 charges capacitor C1 when the plate of D1 is positive. On the other half cycle, capacitor C2 is charged by diode D2. Since the load is across the two capacitors in series, the voltage applied to the load is the sum of the charges on the two capacitors and is nearly twice the peak line voltage. It does not quite reach twice the peak line voltage, because one of the capacitors starts to discharge into the load through the other as the line polarity changes. To say this another way, the two capacitors are charged separately to the same d.c. voltage and are discharged in series to the load. Here again, the size of C1 and C2 determines the output voltage and the regulation.

As in standard half-wave and full-wave rectifiers, the ripple frequency of the full-wave doubler rectifier is twice the line frequency, while that for the half-wave doubler rectifier is equal to the line frequency. For this reason the full-wave type is much easier to filter, requiring smaller values of inductance and capacitance than the half-wave type.

The voltage multiplying action explained above can be carried beyond that of doubling. Practical power supplies have been made using up to 12 doubler stages in cascade. This is an extreme case, and in most TV sets the multiplying action is not carried beyond the quadrupler stage.

A voltage tripler is shown in Fig. 3. Three diodes in a half-wave rectifier combination are used. Diodes D1 and D2 with capacitors C1 and C2 are a half-wave doubler applying twice the line voltage across C2. This is added in series with the voltage across C3 which

is charged by diode D3. The result is a voltage across the load resistance almost three times the applied voltage. D3 carries twice the current of D1 and D2.

The ripple frequency of the voltage tripler is the same as that of a half-wave rectifier because of the unbalanced arrangement. Capacitors C1, C2, and C3 should be at least 16  $\mu\text{f}$  as in the previous doublers. The voltage regulation of the tripler is better than that of the doublers described above because, while the voltage has been tripled, only one multiplying action is present so that the "straight-through" rectifier D3 adds a stabilizing action to the complete circuit.

Fig. 4 shows a voltage quadrupler consisting of two half-wave doublers connected in cascade. The action here is the same as in the half-wave doubler, and the sum of the two doublers is discharged through the load in series. This same action can be cascaded by adding as many doublers as needed.

The regulation with varying loads of typical doublers, triplers, and quadruplers is shown in Fig. 5. A single 25Z6 connected as a half-wave rectifier is used as a comparison with the voltage multipliers. The 25Z6 dual-diode is used in all the circuits, the individual diodes being combined to keep the number of tubes at a minimum. The regulation of the voltage tripler is better than that of either the doubler or quadrupler and is almost as good as a single half-wave rectifier of like size.

The Emerson model 571 TV receiver uses a voltage quadrupler in the low-voltage power supply composed of five 25Z5 tubes arranged as shown in Fig. 6. A filament transformer for certain tubes in the set has an autotransformer primary supplying 125 volts to the voltage quadrupler and to the five 25Z5 filaments in series. Tubes V23 and V24 make a half-wave doubler with two pairs of diodes paralleled to increase the power output of the rectifier. The positive terminal of this

rectifier is grounded to the chassis.

Tubes V20, V21, and V22 form another half-wave doubler with three pairs of diodes in parallel. The negative terminal of this rectifier is grounded.

By connecting terminals 1 and 3 to an ungrounded load (with 1 as the negative and 3 as the positive terminal) a voltage quadrupling action for the sweep circuits is achieved.

The Motorola model VT-71 receiver uses two selenium rectifiers in a half-wave doubler circuit. Some of the tubes of the receiver are connected in series across the power supply to act as the voltage divider for the power supply. The circuit of the doubler for this set is shown in Fig. 7.

A voltage doubler and tripler are used in the low-voltage supply of the Hallicrafter model T54. As shown in Fig. 8, the selenium rectifier with one half of the 25Z6 tube forms a half-wave doubler, supplying a voltage at 1 equal to the line voltage minus the rectifier and filter drop and at 3, a voltage equal to almost twice the line voltage. The output of this doubler is fed to a half-wave tripler consisting of a 6X5 tube and condenser C57B, giving over 300 volts at 5.

The circuit is slightly different than the one in Fig. 3. When the top line of the a.c. input is positive, the selenium rectifier conducts and C60A is charged to almost line voltage. When the line polarity reverses, this voltage, in series with the line voltage, is applied to C58B through the 25Z6, charging it up to twice line voltage. At the next alternation, the line voltage is applied to the 6X5 in series with the voltage across C58B, tripling the original voltage.

The second side of the 25Z6 V15 is a straight half-wave rectifier with positive ground which added to the tripler provides a total voltage step-up equal to almost four times line voltage.

These circuits are representative of the multiplier circuits used in the low-voltage B-supplies of some of the modern TV sets. Variations of these circuits are found in many other makes and models, but all are based on the fundamental circuits shown in Figs. 1 to 4. A study of these basic circuits will be valuable to the technician in isolating power supply failures.

Several manufacturers have used voltage multiplication in the high-voltage power supplies. The Philco model 48-2500 TV receiver is an example, applying some 20,000 volts on the TP400 projection type tube with a voltage tripler.

The horizontal sweep output of the set is applied to an autotransformer which steps up the positive pulse developed by the horizontal retrace to about 7,000 volts. This is applied to a tripler consisting of three diodes as shown in Fig. 9. The output is the sum of the voltages developed across C100, C101, and C102, each of which is approximately 7,000 volts.

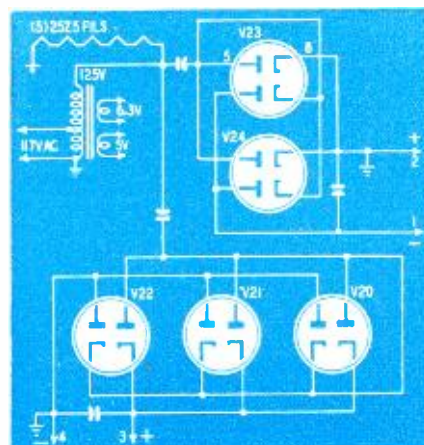

Fig. 6—This supply has two doublers.

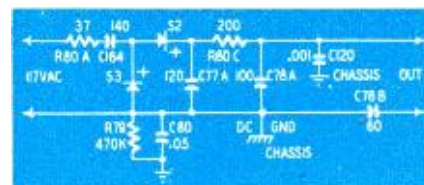

Fig. 7—A doubler using selenium cells.

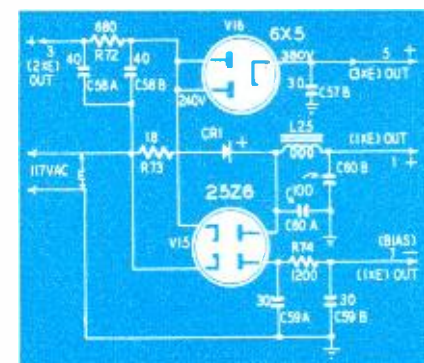
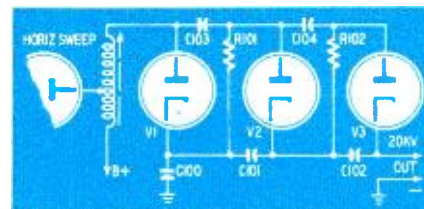

Fig. 8—This supply has four outputs.



ALL CAPACITORS  $\pm$  VALUES IN  $\mu\text{f}$  UNLESS NOTED  
Fig. 9—A 20,000-volt tripler supply.

The action is as follows: The positive going pulse from the horizontal sweep circuit is applied to the autotransformer and is stepped up to approximately 7,000 volts. This causes diode V1 to conduct and charge capacitor C100 to 7,000 volts. At the same time, the plates of V2 and V3 are also made positive to approximately 7,000 volts through condensers C103 and C104 because of the positive pulse applied to these circuits. This charges condensers C101 and C102, which are in series with the cathodes of V2 and V3, to approximately 7,000 volts. C100, C101, and C102 being in series, they discharge in series through the load. The action repeats on each positive retrace pulse, thus maintaining the voltage on the TP400 tube at some 20,000 volts.

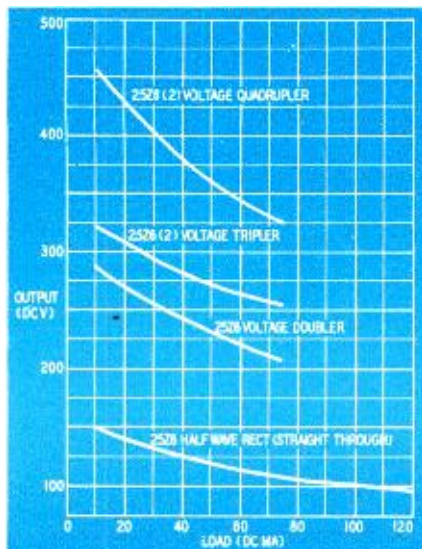

Fig. 5—Multiplier regulation is poor.  
MAY, 1950

# Television Dictionary

(Continued from page 33 of the April issue)

**Monochromatic**  
Single-color.

**Monoscope**  
A tube used to generate a fixed television image, usually a resolution pattern. It is used primarily for test and adjustment purposes.

**Mosaic**  
A photosensitive surface consisting of a large number of individual caesium-silver globules. (See Iconoscope.)

**Multiple scanning**  
The process of scanning an image in two or more individual fields, each containing a fraction of the total picture information. It is also referred to as interlaced scanning or multiple interlace.

**Multiplier**  
A short name for the electron multiplier tube.

**N**

**Negative image**  
A reversed television image in which the dark portions of the televised scene appear bright, and the bright portions appear dark.

**Negative transmission**  
Modulation of the picture carrier in such a manner that the dark portions of the image cause an increase in radiated power, and the bright portions cause a decrease.

**Nipkow disk**  
A rotating disk containing a series of openings or windows and used for mechanical scanning.

**O**

**Odd-line interlace**  
A scanning system in which each field contains an extra half line. In the standard 525-line picture, each field contains 262.5 lines.

**Orthicon**  
A type of television pickup tube using a low-velocity scanning beam to reduce secondary emission from the caesium-silver globules. (See Shading.)

**P**

**Panning**  
Scanning a field of view by moving the camera in a horizontal plane.

**Pedestal**  
A pulse, such as the blanking pulse, used in television systems. (See Blanking pedestal.)

**Persistence**  
The afterglow of the screen chemical of a cathode-ray tube. (See Afterglow.)

**Persistence of vision**  
The ability of the eye to retain the impression of an image for a length of time after the image has disappeared from view. It is this property of the eye which enables it to fill in the dark intervals between successive images and to produce the illusion of motion.

By ED BUKSTEIN

**Phosphor**  
The chemical coating deposited on the face of a cathode-ray tube. This chemical produces light when bombarded by electrons. Various chemicals are employed in practice to produce different colors.

**Phosphorescence**  
Light given off by a phosphor after the exciting light or electron stream has ceased to act. The same as persistence and afterglow.

**Photocell**  
A device for converting variations of light intensity or color into equivalent electrical variations.

**Photoconductive**  
The name applied to a substance which changes its electrical conductivity under varying degrees of illumination. Selenium, for instance, has approximately eight times as much resistance in the dark as in the light.

**Photoemissive**  
The name applied to a substance which emits electrons when struck by light. Caesium and rubidium are examples.

**Photosensitive**  
The name applied to a substance which exhibits photoelectric properties, that is, converts light variations into electrical variations.

**Photovoltaic cell**  
A type of photocell which produces an electromotive force when struck by light. Photovoltaic cells, also called barrier-layer cells, find their greatest application in light measuring devices.

**Pickup tube**  
A tube used in the television camera for the purpose of converting the optical image into its electrical equivalent. (See Camera and Iconoscope.)

**Picture frequency**  
The same as frame frequency. In standard practice the picture frequency is 30 per second.

**Picture tube**  
The cathode-ray tube used in a television receiver. As the spot sweeps across the fluorescent screen, the incoming video signal varies its intensity and produces the dark and light portions of the image.

**Positive transmission**  
Modulation of the picture carrier in such a manner that the bright portions of the televised scene cause an increase in radiated power, and the dark portions cause a decrease. Positive transmission is also called positive modulation.

**Principal axis**  
An imaginary line extending from the center of a lens or mirror and passing through the focal point. (See focal length.)

**Prism**  
A piece of glass having a triangular cross section. White light, in passing through a prism, is separated into its component colors. (See Dispersion.)

**Progressive interlace**  
A system of interlaced scanning in which the first line of the picture is scanned as the first line of the first field, the second line is scanned as the first line of the second field, the third line is scanned as the first line of the third field, etc. (See Sequential interlace.)

**Projection-type receiver**  
A television receiver in which the image is optically projected from the cathode-ray tube to a special viewing screen.

**Q**

**Quadruple staggered interlace**  
A system of interlace in which each frame consists of four fields, and in which the fields do not follow in a progressive order. In this system, line one is the first line of the first field, line three is the first line of the second field, line two is the first line of the third field, and line four is the first line of the fourth field.

**R**

**Raster**  
The rectangular area scanned by the electron beam in the picture tube.

**Reflection**  
The throwing back of images or waves by an object; for instance, the light returned from a mirror. The law of reflection states that the angle at which a ray of light is reflected from a mirror is equal to the angle at which it strikes the mirror. In other words, the angle

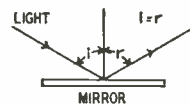

of reflection is equal to the angle of incidence.

**Refraction**  
The bending of a ray of light as it passes from one medium to another of different density. Because of such refraction, an underwater object appears to occupy a position other than that which it really occupies. In passing from a more

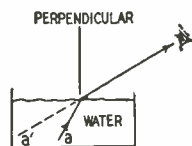

dense to a less dense medium, the light is bent away from the perpendicular. (An object at a appears to be, at a'.) In passing from a less dense to a more dense medium, the light is bent toward the perpendicular.

**Reinsertor**  
A circuit for establishing the d.c. level of a waveform. (See Clamping.)

**Resolution**  
That quality of a television image which enables an observer to distinguish fine detail.

**Resolution chart**  
A test pattern containing a number of converging lines. The point on the screen where these lines seem to merge into one, determines the maximum resolution of the image. Resolution is normally indicated as the number of lines which can be distinguished as individual.

**Resolution pattern**  
Same as resolution chart.

**Retentivity of vision**  
The ability of the eye to retain the impression of an image after the image has disappeared from view. (See Persistence of vision.)

**Retrace**  
The return trace of the spot after it sweeps across the fluorescent screen. Also called flyback.

**Retrace ghost**  
An image produced during the retrace period. It may be due to improper blanking of the iconoscope at the transmitter.

**Return period**  
The time required for the spot to return after each sweep. It is also referred to as return time.

**R.F. power supply**  
A type of high-voltage power supply sometimes used in television receivers.

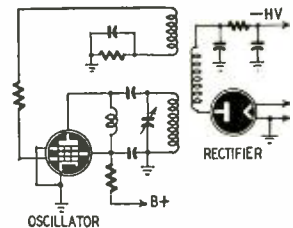

It consists of an r.f. oscillator whose output is fed through a step-up transformer to a rectifier. The output of the r.f. power supply can be filtered with relatively small values of filter components. This ease of filtering results from the low current drain and the high frequency of the ripple. Oscillator frequencies generally used are from 30 to 500 kc. Voltages as high as 5 to 10 kv are obtained directly with this type of supply.

**S**

**Sawtooth**  
A voltage or current waveform which rises linearly to its peak value and then drops rapidly back to its starting level. The sawtooth waveform is used extensively for sweep or scanning in oscilloscopes and television equipment. If the sawtooth is not linear, the spot will move across the fluorescent screen at a varying rate and the pattern will appear to be crowded toward one side. (See Linearity control.)

(To be continued)

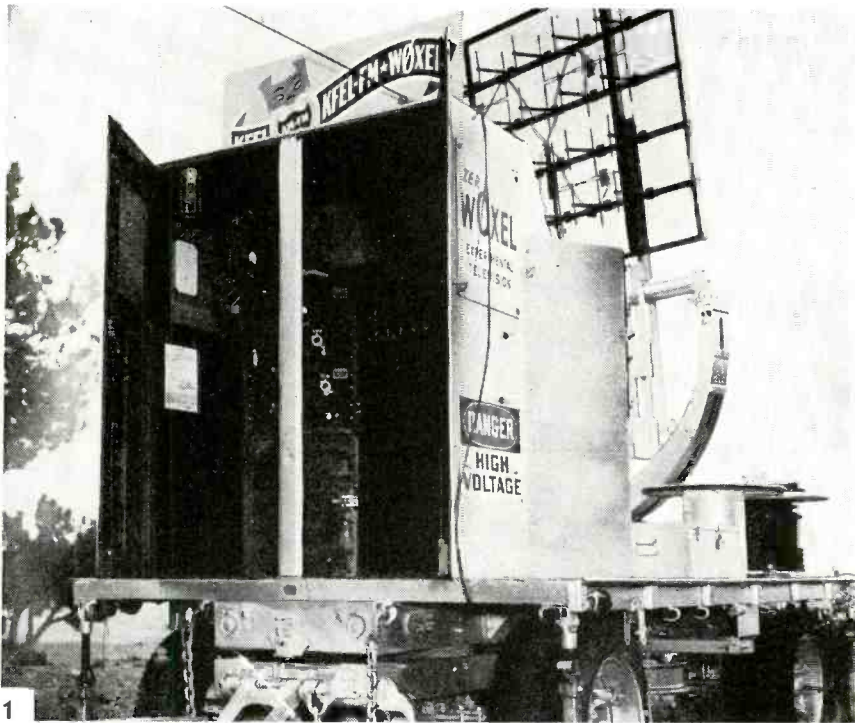

# KFEL TESTS SITE

By EUGENE A. CONKLIN

**K**FEL, DENVER, faced the problem of selecting the best possible site for its proposed new television station. Height especially was necessary for a large service area—long line-of-sight path. Freedom from surrounding buildings was also a major goal, to help reduce possibilities of ghost reception. The final selection was Lookout Mountain, 7,000 feet above sea level and about 2,000 feet above Denver.

The height of the site has another advantage in that a high tower is not necessary. Aside from the economy in cost, that means a long transmitter-to-antenna transmission line, with its losses, will be avoided.

To survey all the possible sites, KFEL used a mobile "test set" mounted in a motor truck. This mobile test station (Photo 1) includes, among other components, a surplus SCR-533 500-watt radar transmitter (capable of generating up to 200 kw on peaks).

Photo 2 is a closeup of the antenna. It has 48 elements and is mounted on a rotating support.

Photo 3 was taken from the doorway of the radio trailer and shows the components of the SCR-533. The transmitter is at the left, the monitor scope and antenna controls in the center, and the power supply and monitor receiver at the right (partially hidden by the doorpost).

If and when the FCC authorizes the use of directional antennas, KFEL will be ready, for they already have such an antenna plotted. It will beam the signal north, south, and east, and will prevent wasteful scattering of power into the unreceptive Rocky Mountains.

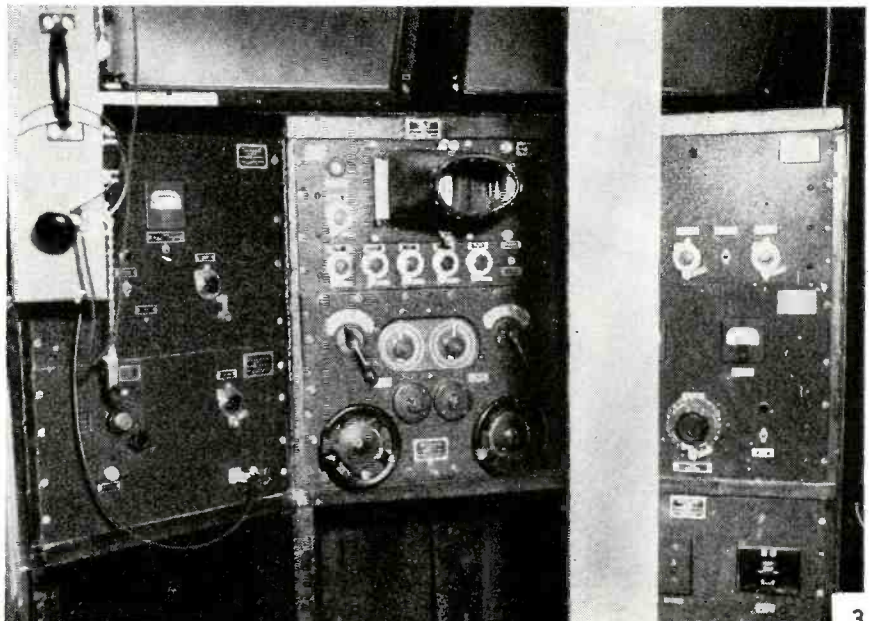
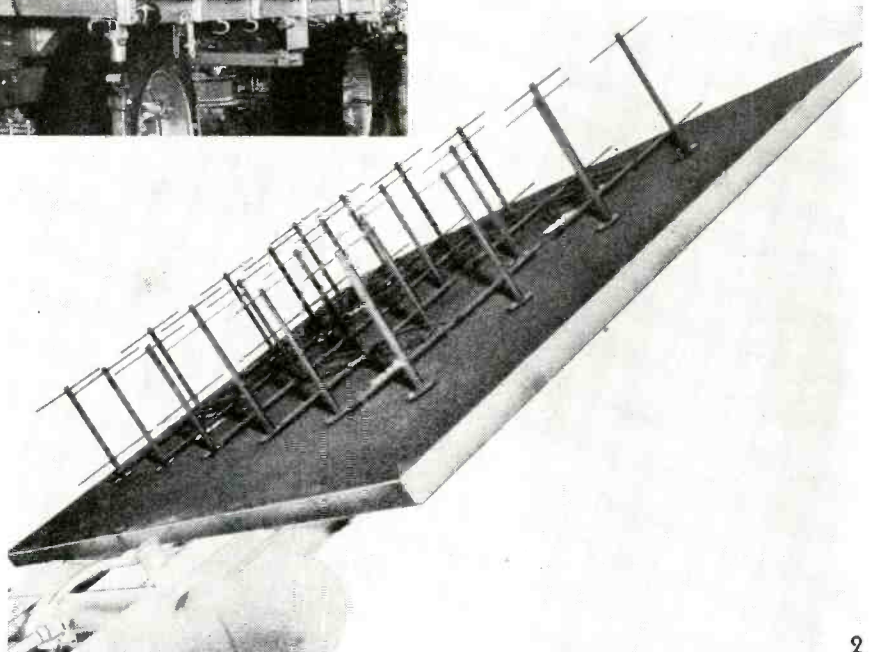

# IRE "Accents The New"

*New principles, new equipment and new methods revealed at meeting of the Institute of Radio Engineers*

**N**EW super-low-loss waveguides that look like—and are—ordinary pieces of enameled magnet wire, a new portable-radio speaker eight times as efficient as present types, practical magnetic amplifiers, a miniature magnetron to work on voltages between 80 and 120, and a new crystal triode called a fieldsistor, which uses a genuine grid surrounding the emitter electrode with a concentric ring of points but not touching the

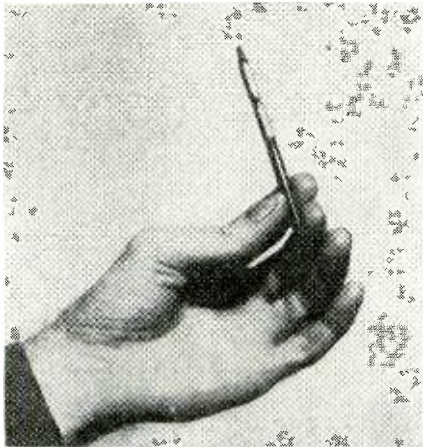

The little tube is a genuine magnetron.



RCA's new miniature television camera.

collector—these were the highlights of the IRE convention and exposition at New York the first week of March.

Other developments were almost as exciting, and some may have been even more important. The world's most powerful radio tube—a 500-kw "beam triode"—was on display. Two industrial television systems were demonstrated—both alike in that they operate on closed circuits, but otherwise vastly different. Du Mont's industrial color television system is designed to a specification of 18 mc bandwidth, 525 lines, at 180 fields per second, producing a color picture with nearly four times the definition of standard black-and-white. RCA's Vidicon system produces black and white pictures comparable in definition to those obtained on standard television receivers. Its features are miniaturization of the equipment and the Vidicon tube which makes it possible. The Vidicon is like an ionoscope in that it uses a mosaic coated on one side of a nonconducting layer, the other side of which is maintained at a steady positive voltage. This layer in the Vidicon is nonconducting only in darkness, and if an image is focused on it, the light portions become "leaky" and permit part of the positive charge to be placed on the particles of mosaic opposite the light portions of the image. The mosaic is scanned in standard fashion. The sensitivity of the tube makes multipliers unnecessary and permits great simplification of equipment.

The Army Signal Corps' surface-wave transmission line is, as the photograph shows, simply a piece of wire. It is coupled to a source of ultra-high frequency with a small horn, and carries it with approximately 10% of the losses of similar lengths of coaxial cable. The action, so strangely different from that of an ordinary conductor carrying current, is due to the dielectric (enamel) on the wire's surface, which reduces the velocity of the waves and tends to "bind" them to the wire. With ordinary sizes of wire and reasonable dimensions of matching equipment at the ends, the system is practi-

cal for frequencies from 300 mc upward.

Another approach to practically the same result was made by Bell Telephone Laboratory scientists in a paper which described artificial dielectrics in waveguide-like structures. In its fundamental form a row of metal discs strung on a rod or wire, this waveguiding device may become a longitudinal row of short transverse dipoles. Corrugated or threaded rods used for the same purpose were described by the Air Force Research Laboratories. Although the exact type or mode of wave transmission may not be identical for each of these structures, the underlying principles appear to be the same, and they all represent a hitherto-unknown way of carrying electricity on a wire, with possibly startling possibilities in future communications, television and other applications.

The portable-set speaker was described by Dr. Harry F. Olson of RCA. Intended to compensate for the low power output of the battery portable, the horn principle was used for its greater efficiency. But a horn of the reduced dimensions necessary in this case would have a higher cutoff fre-

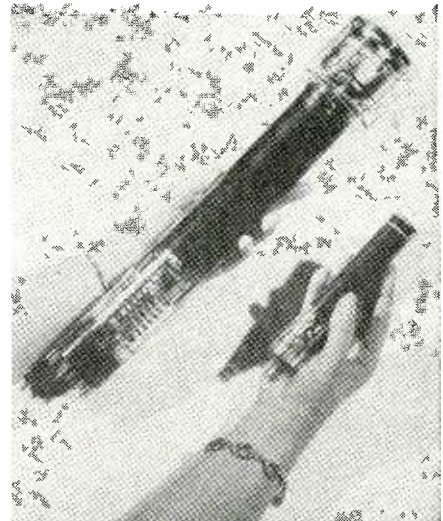

The Vidicon and image orthicon compared.

RADIO-ELECTRONICS for



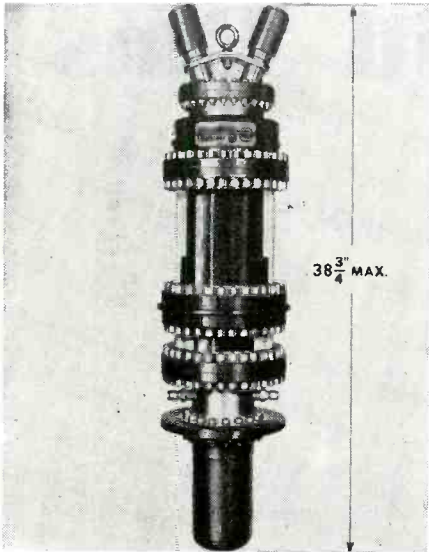

The super-powerful 500-kw beam triode.

quency than could be permitted, even on a portable. So the bass-reflex principle was used to increase the low-note response. In one of the experimental models, a vent was made in the case, and in another V-shaped cutouts in the side of the horn help to keep up the low-note output. A small cone with an air-gap of high magnetic intensity powers the unit.

The 500-kw tube (RCA-5831) is in effect a circle of 48 triodes mounted in slots in a beam-forming cylinder. Thoriated tungsten rod filaments in each of these sends a beam of electrons between two grid rods to the anode. The plate current of this tube is over 20 amperes at 10,000 volts, and the 6-volt filament draws 2,220 amperes.

At the other end of the bigness scale is the *fieldsistor* developed by the Air Force. A crystal triode, its grid element consists of a cylinder of wires surrounding the catwhisker. Their points approach—but do not quite touch—the crystal surface to which the catwhisker is welded. The field created around these points acts as a control over the output, the unit resembling both a transistor and a triode radio tube. It is a crystal like the transistor, but the



The Olson speaker on an RCA portable. V-shaped cutouts act as reflex ports.

control signal is applied in a manner more reminiscent of the action of a triode vacuum tube.

To obtain the extremely small spacing required, the wires are placed in small glass capillary tubes. The tubes are then heated and drawn, reducing the spacing between the wires while retaining the same proportional thickness of wire and insulation. Spacings of almost microscopic dimensions have been achieved by this method.

The magnetic amplifiers exhibited by the Navy received a tremendous amount of attention. Plastic boxes smaller than most midget radios, they have extremely high gain and require no attention nor maintenance throughout their life. While applicable chiefly to such circuits as servos, gun directors and other control devices, it was stated that a magnetic amplifier, powered with a 50-ke a.c. supply, has been used to amplify music, with results which might be described as encouraging, though hardly satisfactory from the standpoint of the high-fidelity enthusiast.

A new miniature transmitter-receiver for air-sea rescues has been developed by the Air Materiel Command's laboratories at Wright Field, Ohio.

Known as the URC-4, the midget set is not much larger than a ration kit and can be held in one hand. It operates with a range of up to 80 miles on a v.h.f. and a u.h.f. channel and can be switched from one to the other instantaneously. Power is supplied by a mercury-type battery in a separate unit. A rubberized cable attaches the battery to the transmitter-receiver section, and the cable is long enough so the battery can be kept in a pocket when the set is in use.

The entire unit is impervious to salt

water and it will stand temperature extremes from -50 to +169° F. The set is designed for ruggedness, and its engineers claim that nothing short of a drop from an aircraft at 10,000 feet is likely to damage it.

These were the highlights of the show as seen by one observer. Another might consider the transistor transmitter more interesting than any of the items mentioned above. In the more than \$7 million worth of equipment exhibited, there was meat for all types of technical minds, and at least one reporter came back with a story of little else but new television test equipment, oscilloscopes, and interference-chasing apparatus.

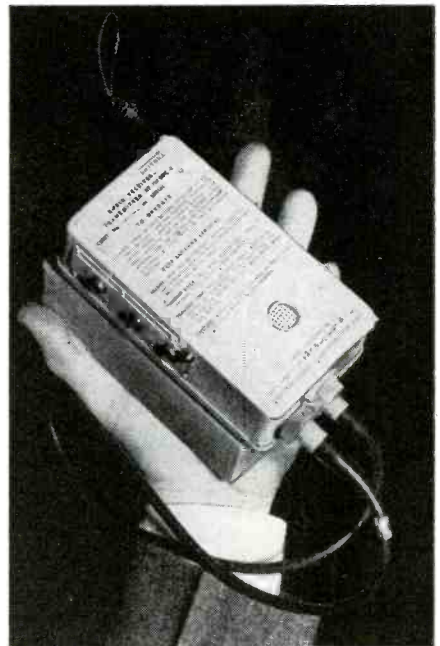

The URC-4 midget rescue transceiver.

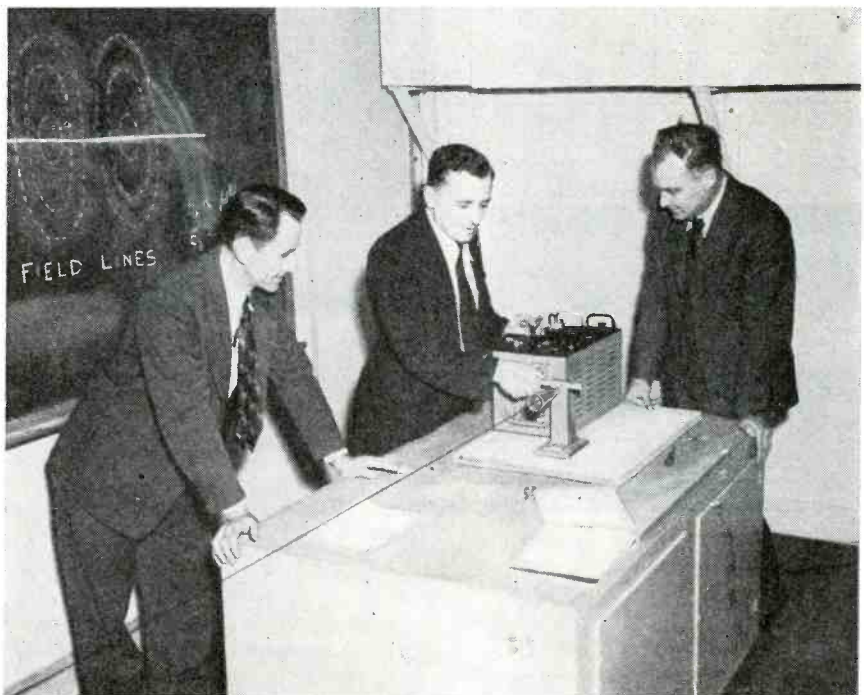

Dr. George Goubau (center) explains his novel surface-wave transmission system.

# Vacuum-tube Grid Bias

**Variety of grid bias circuits that will improve vacuum-tube operation**

By H. B. DAVIS

**A**N ELECTRON tube can operate properly only when the relation between the element voltages is correct. Frequently the only difference between two circuits performing unlike functions is the values of the bias voltages on the grids. The importance of the correct bias voltage is not always appreciated. Effects of wrong bias voltage may appear as distortion, low power output, low voltage gain, overheating, and inefficient detection, to list but a few.

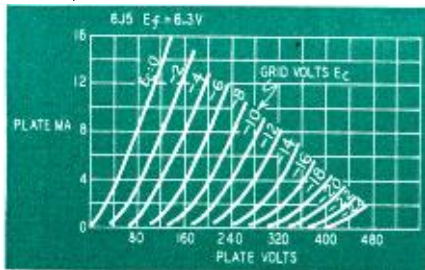

Fig. 1—Curves show relationship between tube's grid voltage and plate current at various plate voltages.

Choice of a bias method may be controlled by the circuit for which it is designed. For example, if plate-supply voltages are low, cathode bias is undesirable, because it lowers the plate voltage still further. The bias methods described here are useful in a variety of circuits. Extremely simple in themselves, they may suggest new answers to otherwise difficult problems.

In Fig. 1 is a family of curves of the plate characteristics of the 6J5. These curves show the plate current that will flow for different plate and grid volt-

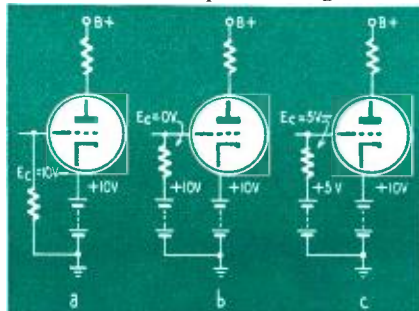

Fig. 2—Bias depends on grid-return point and not grid-to-ground voltage.

ages. The point often overlooked is that the plate voltage is the voltage between the plate and the cathode of the tube and that the grid voltage is the voltage between the grid and the cathode. The cathode-to-ground voltage

may or may not be the grid bias, depending upon the point to which the grid is returned. For example, in Fig.

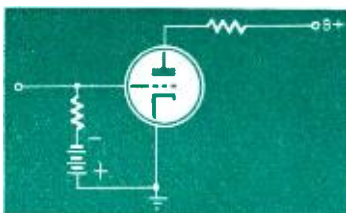

Fig. 3—Elementary type of battery bias.

2-a with the cathode 10 volts above ground and the grid returned to ground, the grid bias is -10 volts because the grid is 10 volts negative with respect to the cathode. In Fig. 2-b, however, the bias on the tube is zero because the grid and cathode are at the same potential. In Fig. 2-c the bias is -5 volts, the grid being 5 volts lower in potential than the cathode. This can be an advantage when the grid must be directly coupled to a point having a d.c. voltage above or below ground.

There are two general methods for obtaining bias voltage: using a separate voltage source or applying to the grid

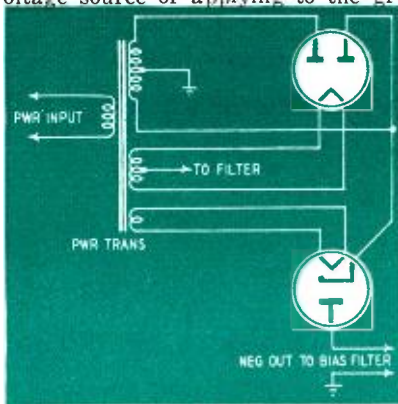

Fig. 4—Separate rectifier supplies bias.

the voltage drop developed across a portion of the circuit.

### Separate Bias Sources

In the early days of radio a common system of bias was that shown in Fig. 3. The cathode or filament was returned to ground, and a battery was connected to make the grid negative with respect to the cathode. This bias method is still used in some circuits today, usually with miniature bias cells in circuits in which no grid current is expected. The same bias would be obtained by putting the bias battery in the cathode circuit,

making the cathode positive with respect to ground as in Fig. 2-a. This is not done, however, because the cathode impedance of the tube would increase with use due to battery aging and the battery ages faster because it carries the entire plate current.

A common method of obtaining bias from the power supply is shown in Fig. 4. With this circuit the negative voltage is determined by the voltage of half the transformer secondary wind-

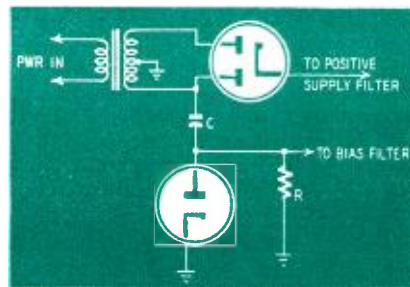

Fig. 5—Shunt diode reduces heat losses.

ing. This is usually too high for bias use and must be reduced by a voltage divider or other means, resulting in loss of power in heat.

A system offering several advantages is the shunt-diode circuit. With the circuit of Fig. 5<sup>1</sup> a voltage divider is formed by the R-C circuit, allowing the desired output voltage to be delivered without the high heat loss present in dropping resistors. C is made only large enough to deliver the desired voltage. The excess voltage appears as a drop across the capacitive reactance, which does not produce heat. Low-voltage components may be used in the

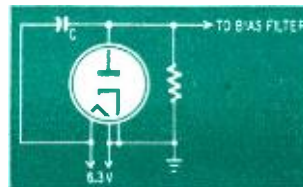

Fig. 6—Filament supply furnishes bias.

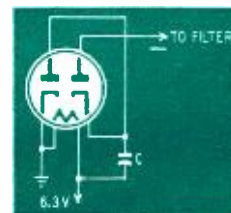

Fig. 7—Voltage-doubler bias arrangement that provides up to 18 volts.

filter, and the heater may be supplied from the winding serving the other tubes.

The shunt-diode system may also be used as shown in Fig. 6 to provide up to 9 volts bias from the 6.3-volt heater supply. A voltage-doubling arrangement such as that shown in Fig. 7 may be used for voltages up to 18 volts from the 6.3-volt supply.

A clever circuit for developing a fixed bias voltage, patented<sup>2</sup> in 1945, is shown in Fig. 8. The bias is developed by rectifying the heater voltage with the diodes in the tube itself. The bias voltage appears across R and is filtered by C. This circuit has the advantages of providing a bias voltage independent of the signal level or tube current and of requiring no more parts than are

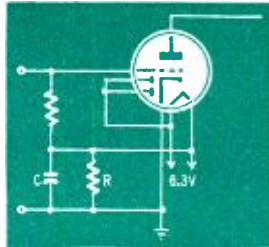

Fig. 8—Internal diodes rectify the bias.

required for conventional cathode-bias systems. No part of the filament-transformer winding should be grounded.

**Self-bias systems**

One of the most popular circuits utilizing the second general method of developing a bias voltage is that of Fig. 9. In this circuit the bias voltage is developed by the plate current of the tube flowing in the cathode resistor R. The current flow is in such a direction as to make the cathode positive with respect to ground. The tube is then biased in the same manner as was

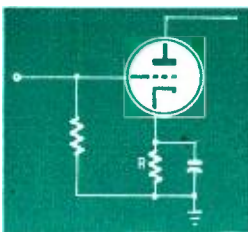

Fig. 9—Common variety of self-bias.

shown in Fig. 2-a. The capacitor from cathode to ground is necessary to prevent the cathode resistor from introducing degeneration. The bias voltage  $E_c$  is  $E_c = RI_p$ , where  $I_p$  is the total cathode current. Bias derived from the cathode current is satisfactory only when the average cathode current is constant, as in class-A amplifiers. In push-pull class-A circuits it must be remembered that the  $I_p$  of the equation becomes the total quiescent current of two tubes, since both tubes operate simultaneously.

In class-C amplifiers or grid-leak detectors (Figs. 10-a and 10-b) there is initially no bias. The tube draws grid current on the positive half-cycle of the input signal. The positive grid swing

causes current to flow in the grid-cathode circuit, through the grid resistor in such a direction as to develop a negative voltage at the grid and charge the grid capacitor sufficiently to maintain the bias during the negative half-cycle of signal swing. This circuit was very popular years ago when grid-leak detection was used almost exclusively.

A system, sometimes known as the back-bias method, for developing bias voltage for the output stage of battery amplifiers is shown in Fig. 11. Bias for

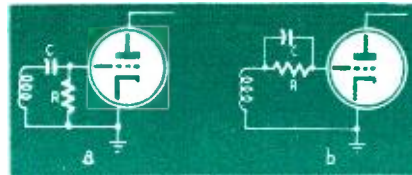

Fig. 10—Two circuits for grid-leak bias.

the grid of the tube is provided by the voltage drop across R. Bias for preceding stages may be taken from appropriate points along R.

In some circuits the bias voltage is developed by floating the negative power supply lead below ground and grounding the bleeder resistor at the point necessary to give the proper bias voltage. A circuit of this type is shown in Fig. 12.

The plate voltage of the tube is reduced by the amount of the bias voltage whenever self-bias is used. That is why separate bias supplies are often used where large bias voltages are required.

A system which does not reduce the

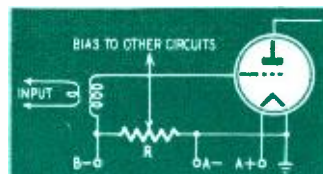

Fig. 11—Total B-current develops bias.

plate voltage is shown in Fig. 13. The bias is obtained by placing the filter choke in the negative d.c. lead and utilizing the voltage drop across the filter choke. The voltage developed is equal to the product of the choke's resistance and the total load current. R and C form a hum filter, necessary because the grid is returned to an unfiltered point in the power supply.

Frequently the grid of a tube must be operated at a relatively high d.c. voltage with respect to ground. A commonly used method of obtaining the proper bias is shown in Fig. 14. If -5 volts bias is required for a tube operat-

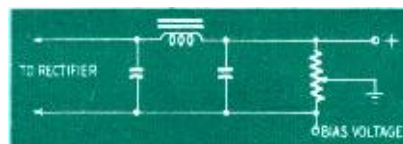

Fig. 12—Bleeder tapped, tap grounded.

ing with its grid at 20 volts above ground, a bleeder network R1-R2 may be used to bring the cathode to 25 volts above ground. The grid is then 5 volts

negative with respect to the cathode. Capacitor C is the usual cathode bypass.

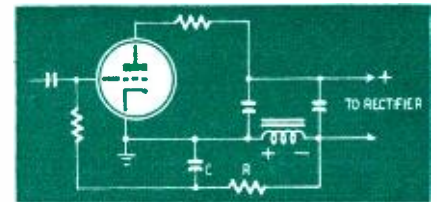

Fig. 13—Choke placed in negative lead.

Although the circuits shown have assumed tubes using cathodes, the same circuits may be used on filament tubes operating from filament transformers by assuming the center tap of the transformer to be the cathode. For example, the circuit of Fig. 9 would become that of Fig. 15. The two capaci-

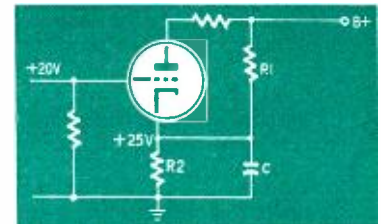

Fig. 14—R1 and R2 are voltage divider.

tors across the filament bypass the signal currents across the inductance of the transformer winding.

Some battery portables have the filaments connected in series across a 6-volt battery; by connecting the grids at desired points along the filament line, from zero to nearly 6 volts may be applied to such grids as require bias. A variation of this system is occasionally found in some three-way sets. The plate current through the output tube used for a.c. operation is used to supply filament current for the other tubes. Thus their filaments become the cathode resistor (or part of the cathode resistor) of the output tube. A few

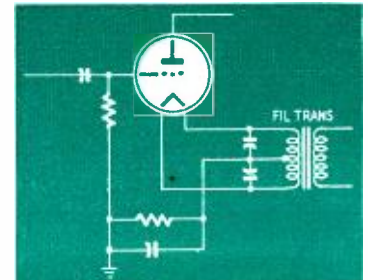

Fig. 15—How to bias a filamentary tube.

battery portables have used bias from the oscillator tube for the output tube. The oscillator of a superheterodyne uses a circuit like that of Fig. 10, and a small current flows through R. By making part of R the grid leak (or part of the grid leak) of the output tube, bias may be obtained without robbing the B-battery as would be necessary if the circuits of Figs. 11 or 14 were to be used.

**References**

- 1 "Use of Shunt Diode for Supplying Bias Voltage," *Electronics*, September, 1945.
- 2 Patent No. 2,75,877 issued to Orville I. Thompson, assigned to DeForest Training, Inc.



# A Signal Tracer and V.T.V.M. Combined

By HARRY HATFIELD

This combination unit provides versatility at low cost.

A VACUUM-TUBE voltmeter and a signal tracer are probably the best instruments for tracking down intermittents quickly, measuring gain and distortion, and making many tests.

This instrument traces a signal from the antenna to the voice coil, detects hum, distortion, and feedback. It measures d.c. and a.c. voltages, resistance, and capacitance. Lightweight and portable, it costs not more than \$35 to construct. The entire circuit appears in Fig. 1. The signal tracer is a three-tube audio amplifier with a self-contained speaker. The output tube is a 6V6 that delivers about 2½ to 3 watts. Biasing the 6V6 is a 500-ohm potentiometer, the bias being used as a d.c. source for the ohmmeter.

A 6SF5 tube is used for the voltage amplifier, having a stage gain of 50. The grid lead should be short and run direct to the signal-tracer volume control. It must be kept away from the heater and power wires, as it is sensitive to hum pickup. A closed-circuit phone jack (labeled LOW GAIN in Fig. 1) is used for most signal tracing.

When the probe is not in the LOW GAIN jack, a high-gain 6J7 amplifier is automatically switched into the circuit. The 6J7 plate and grid leads should be very short and kept clear of (and if necessary shielded from) any hum, feedback, or noise-producing circuits. The grid is run to a closed-circuit jack (labeled HIGH GAIN) which grounds the grid when the probe is not inserted. By using the HIGH GAIN input, signals down to 100 µv or less may be traced.

The probe consists of a shielded lead from a phone plug to a large test prod. A blocking capacitor and a 1N34 crystal-diode detector are placed inside the test prod. A piece of test-lead wire with a clip on one end is soldered to the shield of the probe inside the test prod, and brought out. The clip connects to the chassis or the B-minus lead of the set.

At a and b in Fig. 2 are two variations of a signal-tracer probe. The author has used both arrangements satisfactorily. It is recommended that both arrangements be tried, and the preferred one assembled permanently.

### The v.t.v.m.

A 6SN7-GT is used in a bridge-type vacuum-tube volt-, ohm-, and capacitance-meter circuit. It measures a.c. and d.c. volts with little or no effect on the circuit under test. It will measure inductance also, if allowances are made for the resistance of the coil.

If the v.t.v.m. is built from standard radio parts, it may be accurate to about 8%; but by using 1% resistors, ceramic switches, etc., the error can be reduced to approximately 4 or 5%.

The nine voltage-divider and ohmmeter-comparison resistors are mounted on the 11-position rotary selector switch. The values are based on a 3-volt grid swing in the first (top) triode

of the 6SN7-GT. All the ranges are given in the Range Table.

The 6SN7-GT cathodes are connected together and grounded through an un-bypassed cathode resistor. The change in plate current in one triode produces a potential change across the common cathode resistor which changes the bias on the other 180 degrees out of phase with the grid change in the first. The balanced-bridge output is affected little by B-supply variations, since such changes do not affect the amplification factor of the tube; being in phase and of equal amplitude on each triode, they cancel out. The one-megohm grid resistor is used only to equalize grid input impedance over all ranges, except the 3-volt, 10-megohm range, where some variations will be expected.

The 33,000-ohm resistors are the loads for the 6SN7-GT and the remaining two arms of the bridge (the tubes themselves are the first two arms).

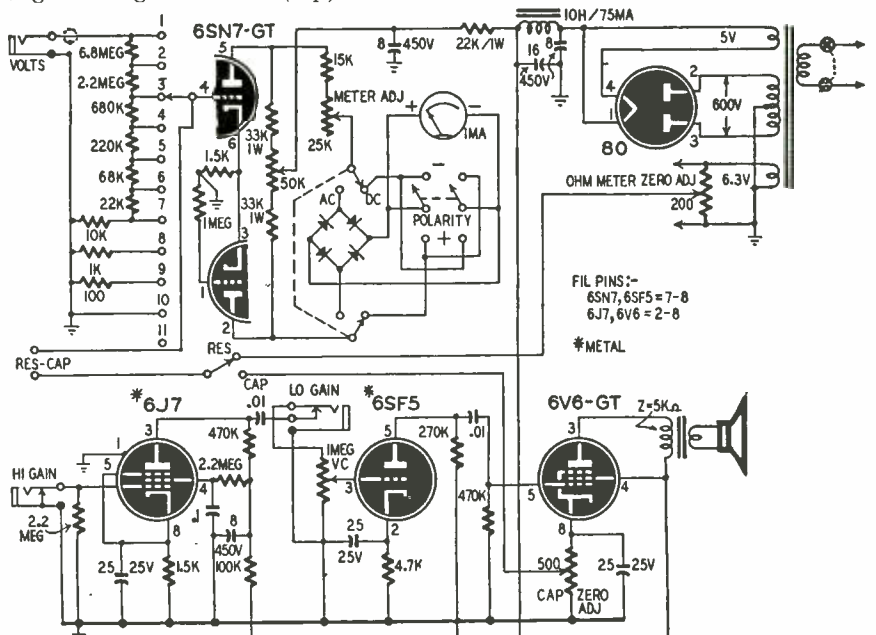

Fig. 1—Complete schematic of the combined signal tracer-v.t.v.m. multimeter.

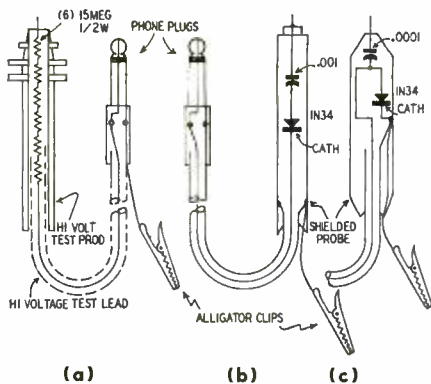

Fig. 2—Probes for tracer and v.t.v.m.

The bridge equalizing potentiometer (50,000 ohms) is adjusted so that the two plate potentials are equal indicated when the meter is at zero. The meter is connected between the plates of the 6SN7-GT in series with the variable 25,000-ohm meter calibration resistor and a fixed 15,000 ohms.

The AC-DC switch places a bridge-type meter rectifier into the circuit for the a.c. and capacitance ranges. The polarity switch permits the reading of either positive or negative direct voltages. The 8- $\mu$ f capacitor and 22,000-ohm resistor form a decoupling network to prevent interaction between the v.t.v.m. and other circuits.

To obtain an a.c. voltage for capacitance, and inductance measurements, a 200-ohm potentiometer was connected across the 6.3-volt filament winding, with one side grounded. The arm is connected to the RES-CAP switch, which selects either an a.c. voltage from the filament potentiometer or a d.c. voltage for measuring resistance from the cathode bias resistor of the 6V6. The conventional power supply requires no explanation.

A high-voltage test probe is constructed as shown in Fig. 2-c. The prod is a large, long, high-voltage insulated test prod with 90 megohms resistance enclosed in the form of six 15-megohm, 1/2-watt resistors in series. A high-voltage-insulated, shielded test lead connects the prod to a phone plug

Range	D.c. volts	A.c. volts	Ohms			Capacitance		
			Min.	Center	Max.	Min.	Center	Max.
1	2.5	3	0.2 meg	10 meg	100 *meg	stray	.00013	.001
2	6	9	—	—	—	—	—	—
3	30	30	20,000	1 meg	50 meg	.0001	.0013	.01
4	100	100	—	—	—	—	—	—
5	300	300	2,000	0.1 meg	5 meg	.001	.013	0.1
6	1000	1000	—	—	—	—	—	—
7	—	—	200	10,000	0.5 meg	.01	0.13	1
8	—	—	20	1,000	50,000	0.1	1.3	10
9	—	—	2	100	5,000	1	13	100
10	— GROUNDED —		— GROUNDED —					

\*—Higher values unreadable.

for insertion into the voltmeter jack. A piece of test-lead wire tipped with an alligator clip is connected to the ground terminal of the phone jack to connect to the low voltage side of item being tested. This probe multiplies all voltage ranges given in the Range Table by 10.

The parts are laid out on the chassis so that the sensitive input circuits of the v.t.v.m. and the 6J7 high-gain signal-tracer tube are far removed from the rectifier and power transformer. The 25,000-ohm v.t.v.m. adjustment needs changing only if a tube or meter is changed; therefore, it is mounted on the chassis inside the cabinet. Copy the meter scale of Fig. 3 or paste it on your meter if it will fit.

**Calibration**

To calibrate the meter, turn the 25,000-ohm v.t.v.m. adjustment to maximum resistance and turn on the power. Set the RES-CAP switch to RES, the AC-DC switch to DC, and the meter polarity switch to +. Set the ohmmeter zero adjust to minimum. Balance the bridge by adjusting the bridge balance control until the meter reads zero. Set the range switch to position 3 and short the ohmmeter terminals.

Connect an accurate multimeter to the RES-CAP jacks and adjust the ohm-

meter zero control until the multimeter reads 3 volts. Set the meter adjustment for maximum meter movement (full scale).

Turn the AC-DC switch to AC, RES-CAP switch to CAP, and capacitance zero adjust to minimum. Short the RES-CAP jacks and connect a multimeter as before. Turn the capacitance zero control for full-scale meter deflection. The multimeter reading should be 3 volts. If it is only slightly off, set the meter adjustment for a satisfactory compromise between d.c. and a.c. readings. Seal it with speaker cement.

Remove the test leads from the RES-CAP jacks. Insert the v.t.v.m. probe into the voltmeter jack; set the AC-DC switch to DC, and the RES-CAP switch to RES. Turn the range switch to position 1. Insert the v.t.v.m. probe tip into the jack that connects with the ohmmeter zero adjustment. Place one multitester test prod on the chassis and the other on the probe tip. When the ohmmeter zero settings are varied, the readings of the two meters should agree on the 2 1/2-volt meter scale.

Turn the range switch to the next position and check the 6-volt range. The lower ranges will read slightly different from the "3" and "10" scales of the higher ranges due to space-charge effects in the 6SN7-GT.

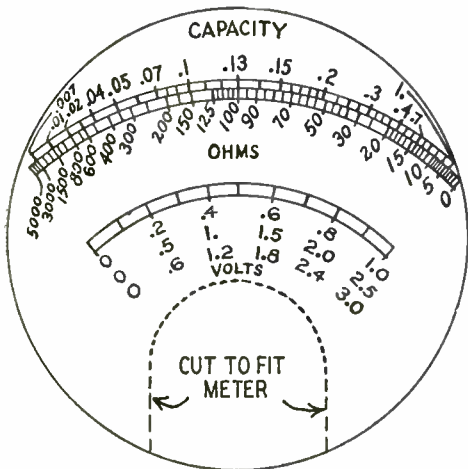
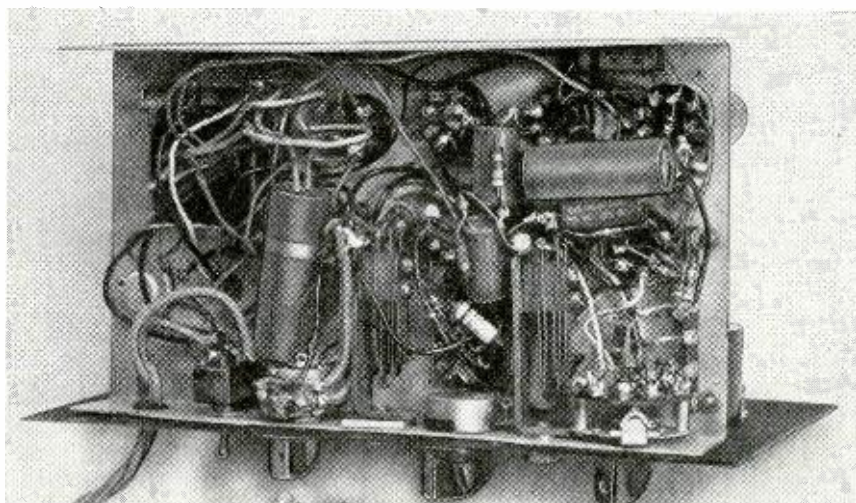

Fig. 3—Cut-out for the meter face. MAY, 1950



Under the chassis. Wiring is point-to-point, with low-level a.f. shielded.

# Fundamentals of Radio Servicing

## Part XV—Sound and Loudspeakers

By JOHN T. FRYE

"The music goes 'round and 'round,  
And it comes out here!"

**N**EVER do I hear the words of that song of a few years back without grinning and thinking they might well be a beautifully brief description of the whole complicated business of radio.

Certainly the music *does* go 'round and 'round from the moment it enters the microphone of the broadcast studio and is transformed into a weak audio-frequency current.

By the time the signal reaches the receiving antenna, it is so enfeebled by its journey that once more it must be nursed back to health before it is ready for the operation of being separated from the carrier. Nurses R.F. Amplification, Conversion, and I.F. Amplification have charge of this building-up process; and Doctor Detection performs the operation. After that, the audio signal must still be passed through the audio amplifier of the receiver before it "comes out here."

The "here" that actually releases the captive sound from the magic spell of electricity is the *loudspeaker*. It might be called a microphone in reverse, for, just as a microphone is a device for changing sound waves into electrical currents, a speaker is a device for changing electrical currents back into sound waves. The speaker is at the very end of the whole process of radio reception, in which it has the very last word. So it stands to reason that it is a most important piece of apparatus. Unless it does its job well, the good work of all the other units goes for nothing.

### Brief review of sound

Since a loudspeaker is a sound device, let's review briefly some of the properties of sound before examining its operation:

Sound is "the sensation produced by a stimulation of the auditory nerves by vibrational energy." Suppose we strike the tuning fork of Fig. 1 and start it vibrating. As a prong of the fork moves back and forth, it alternately causes the molecules of air next to it to be pushed together and to be spread apart. These *compressions* and *rarefactions* travel through the molecules of air. To understand *how*, imagine

that we have several croquet balls lined up in a shallow trough and separated by equal lengths of large-diameter coil spring. If we strike a ball at one end of the trough, it will compress the spring between it and the next ball. That ball will pass this shove along to the next, while the first ball is being thrust backward by the first compressed spring. In this manner the

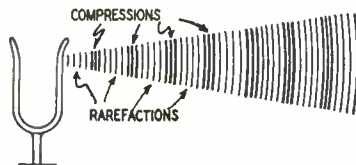

Fig. 1—Vibrating fork sets up waves. motion originally given to the first ball will travel through the whole string, causing each ball first to move closer to its neighbor and then to spring away from it.

In exactly the same way, the thrusts that the tuning fork gives to the surrounding air is transmitted to the ear, and these tiny variations in pressure cause the eardrum to move back and forth with the tuning fork. In that instant, vibration becomes sound.

A compression and an accompanying rarefaction make up a *sound wave*. If we could see these waves moving from the fork to the ear, we would notice that, when the fork vibrates slowly, only a few waves pass in front of us in a given space of time; so we might say that the *frequency* or *pitch* of the sound is low. Moreover, we would notice that the distance between two adjacent compressions is quite great, or that the sound wave is *long*.

On the other hand, when the fork vibrates rapidly, the number of waves passing before us is greatly increased. We say that the sound now has a higher frequency or pitch. At the same time, the wavelength would be noticeably shorter.

When the fork vibrates violently, it gives much stronger shoves to the air molecules than it does when moving through a small arc. The varying amount of energy thus imparted to and contained in the sound waves is referred to as the *intensity* or *amplitude* of the sound. The ear recognizes this difference in intensity as a variation in the *loudness*.

The current that is delivered to the speaker is an *electrical* reproduction of the *physical* sound that fathers it. This current is alternating in nature, but the frequency is not monotonously fixed as it is in the 60-cycle light mains. Instead, it is free to vary from instant to instant so that the electrical cycles per second are exactly equal to the number of sound waves per second striking the microphone. At the same time the power of the alternating current goes up and down in accordance with the intensity of the sound waves. A weak 1,000-cycle tone will produce a weak 1,000-cycle alternating current at the output of our receiver; but a loud 5,000-cycle sound will produce a powerful 5,000-cycle current at the same place.

### The dynamic speaker

Now we are ready to see how a loudspeaker changes this alternating current back into sound. Take a look at Fig. 2, a drawing which illustrates the elements of a loud speaker mechanism.

The *field coil* consists of thousands of turns of wire wound in many layers around the doughnut form that fits snugly around the cylindrical soft-iron *pole piece*. This pole piece is firmly fastened to the rear of the heavy, soft-iron *frame* and projects through the exact center of a hole in the front of this

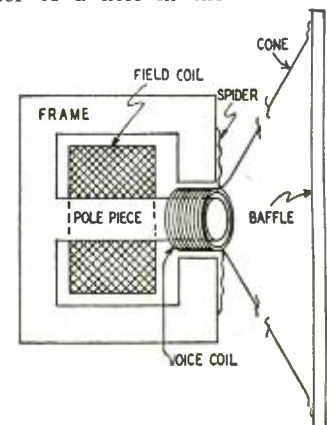

Fig. 2—Cross section of a loudspeaker.

frame, leaving a small space between the pole piece and sides of the hole. A tube of paper with a coil of wire wound in two or four layers around it is slipped over the pole piece and rests in

this space. This is the *voice coil*. It must not touch either the pole piece or the frame; therefore, a flexible brace, called the spider, holds the voice coil centered in the narrow space, allowing it to move freely backward and forward on the pole piece. A paper *cone* is cemented to the voice coil, and the outer edge of this cone is also flexibly supported so that it may move back and forth with the voice coil.

Suppose we pass a direct current through the field coil. From our study of magnetism we know that this will magnetize the pole piece. The lines of force of its field will flow out the front end of the pole piece cross the gap between it and the frame and then return to the rear of the pole piece through the soft-iron frame. There will be a very concentrated steady magnetic field in the small air gap in which the voice coil rests.

Suppose we pass another current through the turns of the voice coil. This current will produce a magnetic field of its own, and we shall have two different sets of magnetic lines of force. The interaction between these two magnetic fields will cause the voice coil to move back or forth on the pole piece. The direction of movement will depend upon the direction of current flow through the voice coil, and the amount of movement will depend upon the strength of the current.

Stopping right here, can't you guess what will happen when we connect the output of our radio receiver to the voice coil? Remember this output is an alternating current whose frequency varies with the pitch of the sound producing it and whose power reflects the loudness of the original sound. Since the direction of movement of the voice coil depends upon the direction of current through it, an alternating current will cause it to move back and forth, exactly in step with the frequency of the reversing current through the coil. Here we have a *vibrating* object that can produce sound! A stronger current will cause the coil to have a greater movement than a weak current; thus a *violent* swing of the tuning fork will produce a *loud* sound that will result in a *strong* current that will cause a *violent* movement of the voice coil and cone and produce a *loud* sound.

The whole thing sounds rather like a dog chasing his tail, but it establishes the point that the sound from the speaker is almost exactly the same as that in the broadcast studio—and that is our goal.

A comparatively recent tendency in this *field-coil dynamic* type of speaker has been to get rid of the field coil. This coil was needed only to create a strong magnetic field in the space in which the voice coil works. (However, radio engineers made a virtue of a necessity and also used the field coil for a filter choke.) In the last few years we have learned how to make powerful, compact, permanent magnets many times stronger than formerly believed possible. When a permanent

magnet is used to replace a section of the pole piece, the speaker works just as it did with the field coil; but a great saving has been made in cost and weight, and we no longer need a source of field coil current. Such speakers are called "permanent-magnet dynamic speakers" or, less formally, "PM speakers."

The human ear cannot hear vibrations of all frequencies. Any frequency between 15 and 20,000 cycles is called an audio frequency, but the range of hearing of most people is probably between 30 and 16,000 cycles per second. What is more, the response of the ear is similar to the spelling of Ohio: "round on the ends and high in the middle," as is shown in Fig. 3. Sounds of equal actual intensity seem much louder in the range between 500 and 3,000 cycles than when pitched either above or below this range.

**Low-note difficulties**

If the ear is to hear low-pitched tones at all, the speaker must move a considerable mass of air to produce the necessary changes in pressure with the comparatively slow-motion movement of the voice coil. That is why the cone is attached to the coil. It acts like a piston and allows the voice coil to set a large quantity of air into motion.

Even this advantage is largely lost at low frequencies without the use of a baffle. As the cone moves forward, it compresses the air in front of it and lessens the pressure behind it. At low frequencies, this cone movement is comparatively slow, and the pressure being built up in front simply slides over the edge of the cone and reduces the partial vacuum we are trying to create behind. It is like trying to use a 3-inch piston in a 4-inch cylinder: most of the pressure simply escapes past the sides of the piston, and the net result is very little change in pressure front or back.

The remedy is to lengthen the path the pressure or sound wave must travel in going from in front of the cone to the back so that by the time it gets there all ready to do its dirty work, the cone has started back and the arriving pressure wave actually contributes to the pressure the backward-moving cone is starting to build up behind the speaker. The name *baffle* is given to the means used to lengthen this path; and the whole baffling subject is discussed at some length in the article by A. G. Sanders on page 31 of the December, 1949, issue of RADIO-ELECTRONICS.

While a large cone and voice coil help to reproduce the low frequencies, the increased mass of these items seriously interferes with the reproduction of high frequencies. If you have trouble in understanding *why*, just reflect on how much easier it is to flutter a handkerchief than a bed quilt! By making the cone out of flexible material we can help the situation, for then the whole cone will move back and forth at the low frequencies while just the inner

portion will follow the rapid vibrations necessary for high-frequency reproduction.

The best solution is the use of two speakers: a small "tweeter" especially designed for the highs, and a large "woofer" that is intended to reproduce the low frequencies. Both of these speakers are often contained in a single unit. A device known as a crossover network separates the frequencies be-

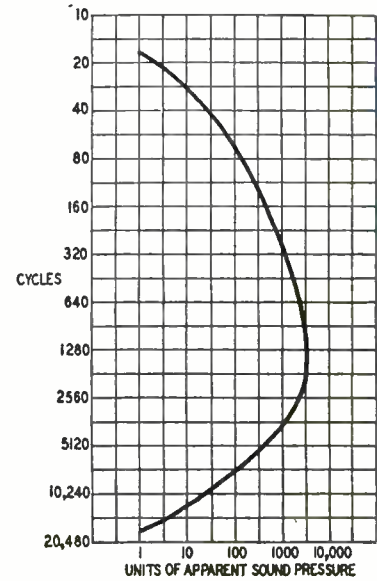

Fig. 3—Apparent sound pressure curve.

low the crossover frequency—usually somewhere between 400 and 2,000 cycles—from those above it and feeds each set of frequencies to the speaker which is best able to reproduce them.

**Repair problems**

Most of the troubles which appear to originate in the speaker of a receiver are actually in the output transformer usually attached to the speaker. A burned-out primary is responsible in nine out of ten cases, and can easily be detected by checking with an ohmmeter. A red-hot screen in the output tube is another indication of an open plate lead and points unerringly to the burned-out transformer primary.

Real speaker troubles consist of shorted or open voice and field coils, of voice coils that are not properly centered and so rub on the pole piece or frame, of breaks in the flexible leads that connect the output transformer to the voice coil, and of cracked, worn, and warped speaker cones. Good speakers have provisions for recentering the voice coil by shifting the spider. The best repairs for the other faults mentioned is simply to replace the defective parts. Small faults in the cone can be repaired with speaker cement; but extensive use of this expedient will result in a cone that is not uniformly flexible and cannot perform as intended. A new cone is a much better repair.

All in all, speakers that have not been excessively abused give very little trouble and in no way deserve the suspicion that radio owners always direct at them when their sets go dead.

# Compact Unit Tests Everything

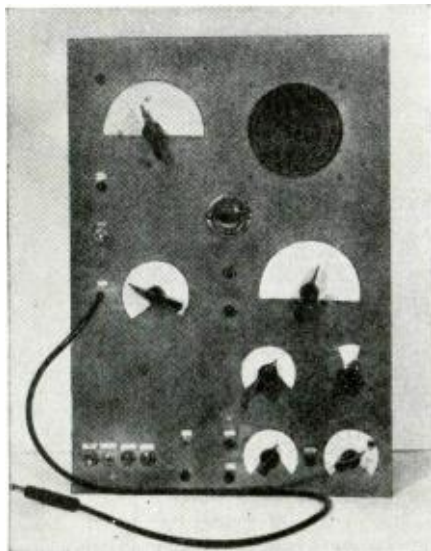

Front view of the instrument. Pointers are used with hand-calibrated scales.

Signal tracer, capacitor tester, signal generator and tuner on one panel.

By WESLEY NEELANDS

RADIO repairing started as a hobby with me. My radio repair equipment consisted of a simple one-tube regenerative rig for a signal generator. When radio repairing had become a part-time occupation, it still didn't justify expensive equipment, but something more elaborate obviously was needed to turn out better work in less time. I leafed through the last two years' copies of this magazine and found that most testers were either too complicated or too simple to suit me, but I picked up some good ideas and put them together.

The test panel devised contains four units: a simple tuning unit, a capacitor tester, a signal tracer, and a signal generator. Fig. 1 shows the complete circuit.

The tuning unit is exceedingly simple. It brings in local stations with good volume and is very dependable and useful for providing music in the work shop; for checking the output of

the signal generator (with a dead radio on the bench one sometimes wonders if the generator is operating); and for checking distortion.

The tuning unit will pick up the output of the signal generator. The r.f. or i.f. signal is heard in the speaker and can be adjusted for modulation and pitch. Distortion is checked by feeding a good voice or music program to the tuning unit and applying the output of the tuning unit to the first audio stage of the signal tracer. The output of the signal tracer then provides an audio signal to use for distortion checks.

The capacitor tester provides a test for all capacitors commonly used. Insert the capacitor between the neon bulb and B-plus. One flash when contact is made and another (on the opposite neon element) when the capacitor is grounded indicates a good unit. No flash shows an open, and a steady glow a shorted or leaky capacitor. For low voltage capacitors, use a voltage divider inserted between B-plus and ground.

The signal tracer is a simple audio amplifier that needs little explanation. The combination of a 6SQ7 and a 6V6 gives very good sensitivity for a triode-pentode combination, having a high-mu triode and a beam-power output. Use shielding as indicated, short leads in plate and grid circuits, no crowding, and adequate filtering in the B-supply. The result is a quiet, stable amplifier.

Two probes, shown in Fig. 2, are required. One a simple shielded probe with an alligator clip for picking up audio signals. For example, it can be clipped to one side of the voice coil with the other side grounded. The tracer then acts as an output meter. The other probe contains a 1N34 germanium crystal. With it, signals can be traced from the aerial to the detector stage. No provision is made in this probe for a return r.f. path and the circuit itself must provide a path or a more elaborate probe is required. The speaker can be switched off to avoid confusion between the output of the test speaker and that of the radio under test. A short circuit switch for the output transformer is needed when the speaker is out or enough signal will leak across the switch to be troublesome.

The 6E5 eye is valuable for alignment, output tests, and comparison of gain from stage to stage. For the latter, it is helpful to set up a chart using different types of good radios that come to your shop. The point on the tester volume control at which the eye closes should be noted as the tracer is put on each test point. The simplified diagram shown in Fig. 3 may be used and the test positions, as numbered, incorporated into the chart.

The signal generator has no plug-in coils and no coil switching. The complete audio range, from a few cycles per second to the inaudible frequencies,

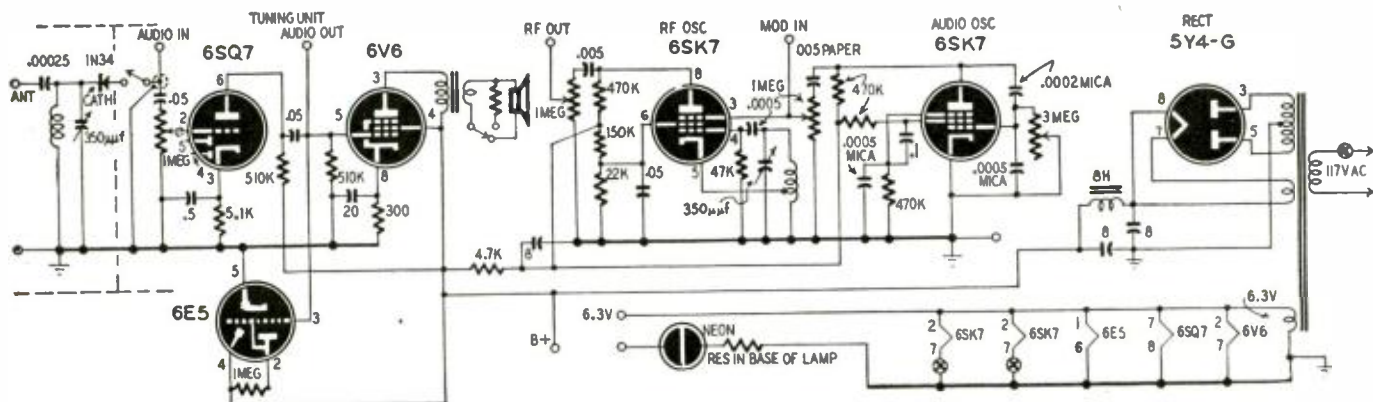
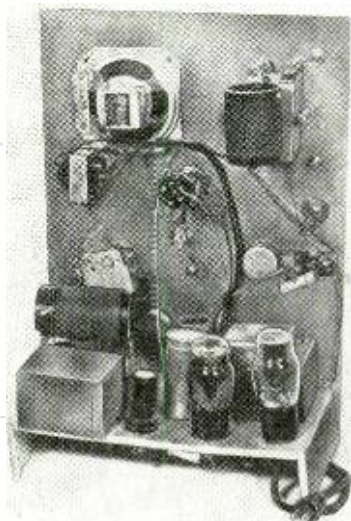

Fig. 1—There are three units—tuner-tracer, sig gen and power pack. Pin jacks permit many tests and supply various voltages.





The instrument as viewed from the rear.

is available at the turn of a knob. The r.f. and i.f. range covered is from 456 to about 1450 kc. The r.f. can be modulated with any desired audio note at any desired percent modulation. The r.f. or i.f. can be modulated by the output of the 6SQ7 or from an outside source. When this is done, the filament of the audio generator is switched off and the a.f. output jack becomes the modulation input jack.

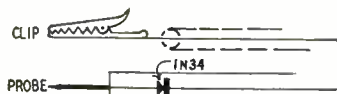

Fig. 2—The r.f. and a.f. signal probes.

One fault with this generator is that the audio signal from this type of oscillator is a sawtooth wave and is difficult to interpret on an oscilloscope. For all other purposes it is just as good as a sine wave. The stability and range of the audio wave are affected by the values of the plate to grid capacitor, the screen resistor, and the screen to suppressor capacitor. The values given should prove satisfactory.

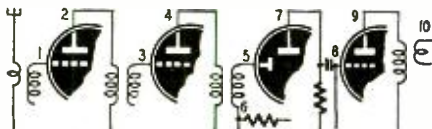

Fig. 3—Rough signal tracing procedure.

To cover the required i.f. and r.f. frequencies, I had intended to switch in a small trimmer capacitor and made provision for this on the panel. I was surprised to find it possible to wind a coil that covers from just below the required i.f. of 456 kc. to almost the top of the broadcast band. Thus all the commonly required frequencies are available with one twist of the wrist. The tuning coil is 85 turns of d.c.c. copper wire wound to nearly 2 inches on a 2-inch form, and the oscillator coil has 104 turns of d.c.c. wire occupying 2½ inches on a 2-inch form with the cathode tap at 38 turns above ground. No. 26 d.c.c. wire is roughly correct without noticeable spacing. I plan to

use the switch for switching in short wave coils if needed.

The large, heavy aluminum panel effectively shields a radio from signals radiated directly from the coil, but, with a probe inserted, a strong signal is radiated. If used close to other radios, it might cause interference. The circuit of the r.f. generator is the familiar Hartley electron-coupled oscillator. Too large a grid leak may cause instability. That is, the oscillator may squeal at certain settings because of grid blocking. The screen voltage must be kept at a moderate figure.

It may pay to experiment with the location of the tap on the coil. Do not be satisfied until you have a signal

which is inaudible until modulation is added or the signal beats against some other r.f. signal. In either case the signal should be quite loud.

Most of the layout can be seen from the photograph of the panel. Coils are mounted on the backs of the capacitors and the output transformer is on the speaker. The chassis is 11 x 7 x 2½ inches, allowing plenty of room for the power transformer, tubes, can-type filters, and the filter choke. The panel is 12 x 17 inches.

The only other equipment necessary to repair radios even on a part-time basis is a volt-ohmmeter (a.c.-d.c.), a tube tester, and a thorough knowledge of radio.

## Capacitance Measurement with Signal Generator

CAPACITANCES below .0005  $\mu$ f cannot be measured accurately with ordinary bridge circuits. A signal generator in connection with a standard radio solves the problem simply and accurately with no extra drain on the pocket.

Nearly every radioman has this instrument and one who has not may construct one.

A problem arose concerning some nonstandard coded micras of low capacitance stores. With no further waste of time and money, I thought of a way to use my signal generator to solve the difficulty. I connected a .0005- $\mu$ f linear-type variable capacitor in parallel with a signal generator log-type tuning capacitor with the shortest possible plug-in leads so that the original calibration would not be affected when this extra unit is disconnected. There being 100 divisions on the linear unit dial, the signal generator dial was marked for each degree by spotting the signal on the radio receiver in turn with the calibrating capacitor and the signal generator's own. In this way the signal generator capacitor was calibrated in terms of the linear one.

The capacitance for each division marked will be .0005  $\mu$ f divided by 100. The calibration, of course, will be crowded on the low-frequency end of the dial and may be marked for convenience. With a big dial, the task will be easy and more accurate.

To test a given capacitor, set the signal generator variable capacitor for minimum capacitance and plug in the capacitor under test. Tune in the signal on the radio receiver on the appropriate band. Unplug the capacitor and leave the radio receiver as tuned. Tune the signal generator in to spot the signal on the radio. The pointer on the signal generator will now directly indicate the value of the capacitor under test. Care should be taken to distinguish fundamentals from harmonics when

measuring a capacitor by this method.

This method also provides a quality test. If the signal cannot be tuned, it may be due to large leakage stopping the signal generator. Should it be open, stray capacitance will deviate the signal very little. (For low capacitances, the h.f. band will be more accurate and convenient.)

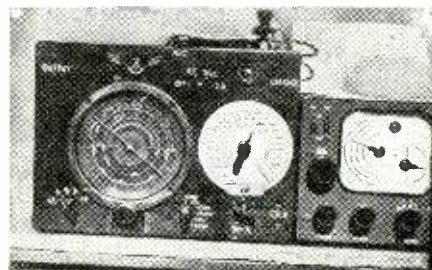

Dial is calibrated in capacitance units.

Interelectrode capacitance of tubes also can be measured by this method, and by comparison with good tubes, an open element can be found easily.

I constructed the signal generator (see photo) from an article, "Better Signal Generator" in the 1946 Radio-Electronics Reference Annual. It was supplemented with a capacitance and resistance checker bridge circuit described in the same Annual. By combining two in one, the power supply cost was cut down. Of course, an additional winding of 60 volts on the power transformer for the bridge circuit was required. The 6E5 tuning eye in the bridge is a null indicator and also has been used as a low-range v.t.v.m. and for a.v.c. checking and alignment work.

The instrument also has been used as a Morse code practice set as well as with a receiver to provide modulated signals. Thus maximum returns have been achieved with minimum of cost. Hope that the setup will encourage readers toward home-made test instruments.—Raojibhai J. Patel

# Servicing Vibrator Power Supplies



A full-wave non-synchronous supply.

**S**ERVICING automobile receivers and other equipment with vibrator-type power supplies is no harder than servicing a.c. apparatus, yet many technicians don't like to tackle this type of equipment. They usually feel that extra test equipment and batteries will be required, and that work on vibrator supplies is tedious or tricky.

Neither of these ideas is necessarily true, although a 6-volt storage battery

are open, the energy stored in the magnetic field of the primary winding tries to keep the current flowing in the coil. Since the resistance of the vibrator contacts has changed from zero when closed to almost infinity when open, the voltage across the winding rises to an extremely high value (1,000 volts or more) in the attempt to keep the current flowing across the contact gap.

Since this inductive surge will damage the transformer or ruin the vibrator points, a buffer capacitor is placed across the transformer secondary to absorb the voltage peaks. When the vibrator contacts are closed, the capacitor charges. The inductive surge is opposite in polarity to the charge on the buffer capacitor so that it must reverse the charge on the capacitor

brates very feebly. The longer contact periods of the vibrator points cause saturation of the transformer and sparking occurs.

If the secondary current drain is excessive, the vibrator current also is excessive and the vibrator is slated for early failure. Although the secondary winding actually contains a form of alternating voltage, the rectifier tube draws current only if this voltage has a certain polarity. This amounts to forcing pulsating d.c. through the secondary, and the inductance of this winding acts like a choke and limits the amount of current which can be drawn through it. The practical limit is about 30 milliamperes at 180 volts.

The action just described can be understood more clearly by referring to the voltage and current waveforms in Fig. 2. When the square-topped portion of the voltage waveform has the correct polarity to be passed by the rectifier tube, the energy transfer is high. If the rectifier draws power from the *bottom* of the wave, the output is being obtained only from the energy stored in the transformer core. The result is low output and poor vibrator operation. This condition can be corrected by reversing the battery leads.

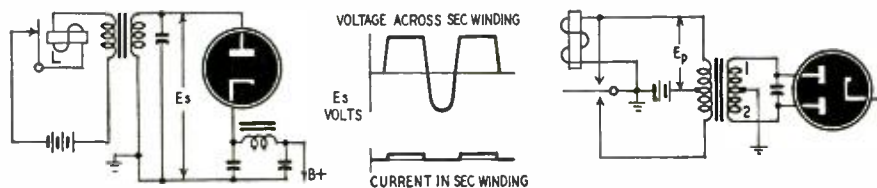

Fig. 1, left—Half-wave vibrator supply. Fig. 2, center—Voltage and current half-wave supply waveforms. Fig. 3, right—Full-wave, non-sync. vibrator.

or battery eliminator is desirable if much work is to be done on auto receivers or battery-operated PA systems. Servicing both synchronous and nonsynchronous power supplies is quite simple once the underlying principles are understood.

## Basic theory

Three general types of vibrators are in use today: half-wave nonsynchronous, full-wave nonsynchronous, and synchronous. The half-wave type is shown in Fig. 1. Voltage applied to the vibrator's series electromagnetic coil makes and breaks the circuit about 85 times per second. The pulsating current thus produced in the transformer primary induces an a.c. voltage in the secondary, which depends on the turns ratio of the transformer and the vibrator frequency.

When the vibrator contact points

before it can begin charging in the opposite direction. By this time the inductive surge has been used up or reduced to only a few volts.

The half-wave circuit in Fig. 1 has several disadvantages because of the series vibrator coil and single secondary winding. Since the coil is in series, the current through it depends on the current load placed on the secondary winding. If the current falls below a certain value, the efficiency of the vibrator varies and it flutters or vi-

## Full-wave circuits

Full-wave nonsynchronous circuits avoid the above disadvantages (see Fig. 3). Here, the vibrator coil is connected in parallel with the vibrator contacts instead of in series, and draws a constant amount of current regardless of the secondary load. This full-wave circuit is actually two half-wave circuits placed back-to-back so that each alternately supplies half of the output wave. This keeps the output voltage polarity correct, so that each

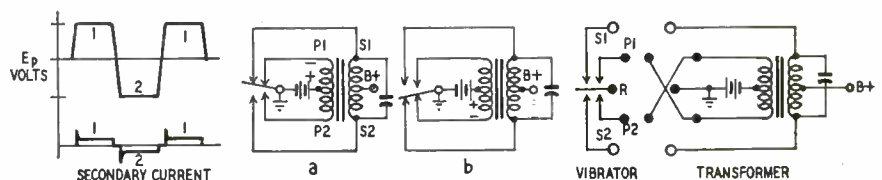

Fig. 4, left—Full-wave supply increases efficiency. Fig. 5, center—Synchronous supply eliminates rectifier. Fig. 6, right—Reversing plug for vibrator.

half of the rectifier conducts, and there is no need for observing battery polarity.

Since one-half of the transformer secondary is always providing d.c. output, the inductive surges in each half balance each other. No d.c. is drawn through the secondary, and the voltage output may be increased as much as desired simply by increasing the turns ratio, the only limit being the eventual overloading of the vibrator if this is carried too far. The increase in efficiency is shown in the voltage and current waveforms in Fig. 4.

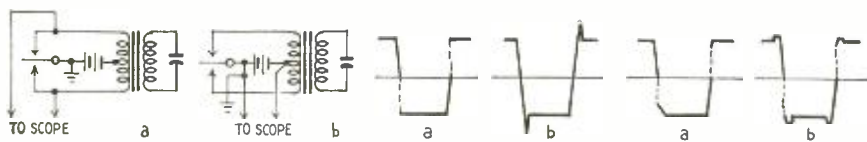

Fig. 7, left—Oscilloscope connections for waveform observation. Fig. 8, center—Non-synchronous supply waveforms. Fig. 9, right—Synchronous waveforms.

The synchronous vibrator supply permits a simpler, more compact circuit arrangement since the rectifier tube and socket are eliminated. In Fig. 5-a, the battery voltage is applied across the primary winding of the power transformer. This voltage is positive at the centertap and negative at P1. The transformer produces a high positive voltage at the secondary centertap and the secondary winding is negative at S1. (The negative return is grounded through the vibrator reed.) When the reed is in the position shown in Fig. 5-b, the primary centertap is again positive, and this time P2 is negative. The secondary voltage still is positive at the centertap, but is now negative at S2. Thus the output voltage at the secondary centertap is always positive d.c., regardless of the position of the vibrator reed.

The main disadvantage of this circuit is the necessity of observing battery polarity. The wrong polarity will damage both the vibrator and the filter capacitors if allowed to remain for even a short time. Some manufacturers provide for reversing vibrator polarity in different makes of automobiles by equipping the vibrator with a special six-prong base; polarity is reversed by removing the vibrator from the socket, rotating it 180 degrees, and re-inserting (see Fig. 6). Some of the older receivers did not make such provisions, and polarity had to be reversed by reversing the primary leads of the power transformer.

**Servicing methods**

Two good methods of checking a vibrator supply are waveform and voltage and current measurements. Both are simple and take up little time. Useful information can be obtained by observing both the voltage and current waveforms with an oscilloscope. The voltage waveform shows the condition of the vibrator itself and whether it is electrically matched to the circuit, and the current waveform indicates the condition of the circuit and whether the vibrator is correctly connected to

it. Oscilloscope connections for observing waveforms are shown in Fig. 7. The voltage wave (7-a) can be checked by connecting the vertical scope leads to any convenient point across the power transformer primary, usually at the vibrator socket. The current waveform (7-b) is obtained by connecting the vertical leads of the scope at any convenient point between the A hot line and ground. (Since the vibrator draws a pulsating current from the battery, the voltage drop in the battery line will have exactly the same waveform as the current.)

The vibrator must operate smoothly both before and after the tubes have warmed up. A full-wave nonsynchronous vibrator should have the waveform shown in Fig. 8-a as soon as the receiver is turned on. This form should not change appreciably when the full load is applied. If it resembles that of Fig. 8-b, either the vibrator is badly worn or the buffer capacitor has insufficient capacitance. The vibrator should not be replaced until the buffer has been checked or replaced. The buffer

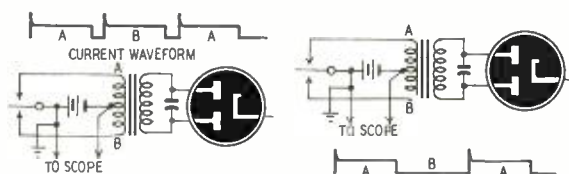

Fig. 10, left—Proper full-wave load balance. Fig. 11, center—Open at B upsets balance. Fig. 12, right—High-resistance joint in secondary unbalances current.

should be replaced as a safety measure each time a new vibrator is installed, even if it checks good.

A synchronous vibrator in good condition has a waveform across the primary similar to Fig. 9-a before the load is applied. This is essentially the same as Fig. 8-a. When the tubes have warmed up, this waveform has the pips or "ears" seen in Fig. 9-b. These ears are normal, because the secondary points on the vibrator are set wider than the primary points and do not place any load on the vibrator until slightly after the primary points have made contact.

Suppose the vibrator has short life, although it appears to operate smoothly and the current drain is about normal. A check of the current waveform will show whether the load is equally distributed between each set of contacts. In the normal full-wave vibrator, each contact feeds one plate of the rectifier tube and the load is shared by the two contacts. Proper load balance is indicated when the height of each consecutive current pulse (A and B in Fig. 10) is equal.

**Current waveform tests**

In some tests, the current waveform is more helpful than the voltage waveform. For example, suppose half the transformer primary winding is open (Fig. 11). The output voltage waveform may be almost normal, but the fault will be apparent immediately in the current waveform. Since no current can flow in contact B because of the open winding, there will be a long "off" period between adjacent current pulses (compare A with B in Fig. 11). This will cause short vibrator life because one set of points is forced to carry the entire load. This same thing can happen if one of the rectifier plates is weaker than the other. The shape of the current waveform in this case will resemble that in Fig. 12-a. Note the decreased height of current pulse B as compared with the pulse A. The same waveform could be caused by a high-resistance joint in the secondary winding or at the tube socket. If the secondary winding is open at B, the waveform will have the slope as shown in Fig. 12-b.

Note the small peaks which appear at the front edge of each current pulse. These are caused by a charging current for the buffer capacitor and should be no higher than two or three times the height of each current pulse under normal load. It is not necessary that each peak be exactly the same, but a value higher than normal indicates ex-

cessive buffer capacitance and will result in short vibrator life. Excessive charging peaks will also cause hum in the speaker by being induced into the voice coil by way of the field coil of the speaker.

Too large a buffer capacitor will give the voltage and current waveforms shown in Fig. 13. The waveforms in Fig. 14 are usually the result of using a vibrator designed for a high-frequency unit at low frequencies. The waveforms show a saturated power transformer as the result of the vibrator contacts being closed for too long a period. This should not occur if the manufacturer's recommendations for vibrator replacement have been followed.

**Current drain**

The current drain of the set should be checked against the manufacturer's specifications. If these are not available, check the vibrator current by allowing the tubes to warm up and taking a current reading of the battery with the vibrator in the circuit, then with it removed. The difference in

readings is the vibrator current.

Roughly, this current should be 2 amperes for each power tube in the receiver,  $\frac{1}{2}$  ampere for the converter tube, and  $\frac{1}{4}$  ampere for each of the other tubes. The rectifier is not included, since it draws no current from the vibrator. If the actual vibrator drain is much more than the above approximations, the various components should be checked.

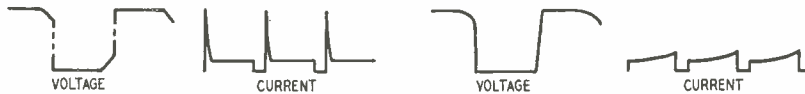

Fig. 13, left—Too large a buffer capacitor peaks the current. Fig. 14, right—High frequency unit used at low frequencies saturates power transformer.

Most likely causes of trouble are: high leakage in the filter capacitors, leaky or shorted coupling or bypass capacitors in the output stage, defective output tube, or a faulty resistor or capacitor in the cathode bias circuit. Defective parts in other stages may also contribute to the excessive current drain.

In nonsynchronous circuits, the trouble can be isolated quickly by removing the rectifier tube; in synchronous circuits by disconnecting the centertap of the transformer secondary. The current drain through the vibrator under these no-load conditions should be 1 ampere or less. If more,

the trouble is in the vibrator, buffer capacitor, or power transformer. If replacing the first two does not reduce the current drain to normal, the transformer itself is defective and must be replaced.

The input current can be checked without removing the receiver from the car by making up an adapter like the one shown in Fig. 15. This adapter consists of a standard and a clearance-

type fuse holder and plug, a d.p.d.t. switch (toggle or knife-type rated at 6 amperes or more), for reversing the meter, and a d.c. ammeter (0-15 or 0-20 amps).

The current can be measured directly by connecting the adapter in series with the hot battery lead. The current reading should be taken with the car motor off and with no other load on the battery. The battery voltage should be as close to 6 volts as possible when the readings are made.

#### Vibrator life test

The life expectancy of vibrators which have been in the set for a long

time but are still in good condition can be predicted by making the following tests: First, replace the 0Z4, if one is used, with a 6X5 for the tests. Then, with the set operating, but with no station tuned in, check the plate voltage. This should be within 10% of the manufacturer's rating and should vary not more than 4% (this would be  $\pm 10$  volts at 250 volts plate voltage approximately).

Drop the input to 4 volts by connecting the hot lead across two cells of the battery. Disconnect the set for about 1 second. This allows the vibrator to stop but does not allow the tubes to cool. Then apply battery voltage to the receiver several times in succession. The vibrator should start consistently at 4 volts as long as the

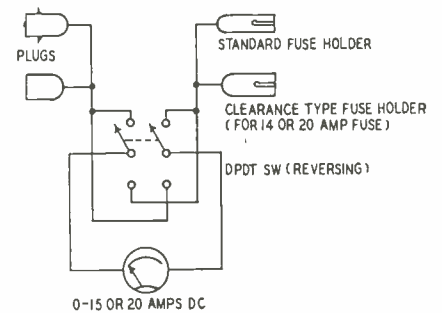

Fig. 15—Adapter for car radio check.

## CURING MODULATION HUM

WHEN hum in receivers and amplifiers is not produced by faulty filtering, stray a.c. fields, and other common faults, it may be caused by heater-to-cathode leakage in one or more of the tubes.

The easiest method of locating the bad tube is by substitution. However, this method is not too reliable unless two or more of each type tube are available.

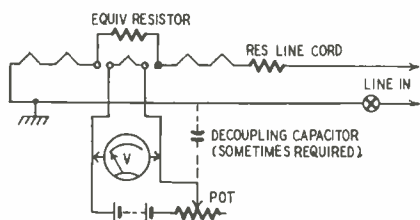

Fig. 1—Series heaters need resistor.

Another method is to disconnect the tube heater from its a.c. supply and use a battery to heat it. The battery should deliver the required voltage and current. A rheostat and voltmeter can be used to adjust the voltage to the correct value. Try this on each tube until the hum disappears. This tube should then be replaced by one of the same type hand-picked for hum-free service.

Fig. 1 shows the connections for a.c.-d.c. type sets having series filament strings. In such sets, the heater string must be completed by a resistor equal to the "hot" resistance of the heater

it replaces. The resistance is equal to the heater voltage divided by the heater current in amperes. Fig. 2 shows the connections for making the test on a.c. sets.

If instability is experienced during—or because of—this test, bypass one side of the heater to chassis or B-minus. Use a .001- $\mu$ f capacitor for r.f. circuits and a .01- $\mu$ f unit for a.f. circuits.

If the hum is strong, start testing tubes at the front end of the set or amplifier. If it is weak, start at the output stage. Do not overlook the rectifier tube. It can cause this trouble just as easily as the others can. Be extremely careful when testing rectifier tubes.

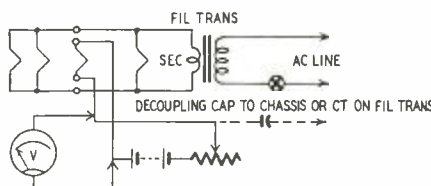

Fig. 2—Rheostat varies the voltage.

This method is especially effective in checking high-resistance leaks between cathode and filament of the power tube in series-filament receivers. The leakage may be so slight as to be undetectable on any tube tester but be very noticeable when it has the whole voltage of the filament string across it.

—Ludwig Furth

tubes are hot. Failure to do so indicates trouble in the near future with normal starting voltage. Although plate voltage with the 4-volt input should be two-thirds normal, the vibrator is still good if the reading is only half normal. In most commercial service jobs, however, it will be safer to replace such a vibrator, as its life is not likely to be long.

Most modern vibrators are treated or hermetically sealed in the can to prevent accumulation of film on the contact points when stored in high humidity for a long period of time.

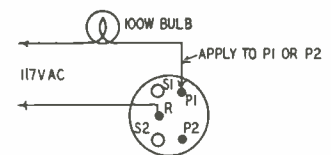

Fig. 16—Circuit for clearing points.

This film often prevents starting under normal conditions. If this happens, turn the set on and allow the tubes to warm up, then snap the switch off and on rapidly several times to start the vibrator. A few minutes' operation should remove the film. If the vibrator will not start, remove it and apply 110 volts a.c. to the points in series with a 100-watt light bulb (see Fig. 16). A half minute of this treatment will clear the film without damage to the vibrator.

Diagrams, material and the photo contained in this article appear in the Radiart vibrator manual and are included with permission of the Radiart Corporation.

# THERE'S ONLY ONE COMPLETE CATALOG FOR EVERYTHING IN RADIO AND TV!

IT'S YOUR **FREE**  
**ALLIED** 196-PAGE  
 VALUE-PACKED CATALOG!

**SEND FOR IT TODAY**



Here's the only *complete* Buying Guide to everything in TV, Radio and Electronics—packed with the world's largest selections of quality equipment at lowest money-saving prices! See the latest in TV, AM and FM receivers; radio-phonos; new Sound Systems and P.A. equipment; high-fidelity custom sound components; recorders and accessories; full selections of newest Amateur receivers and station gear; test instruments; builders' kits; huge listings of parts, tubes, tools, books, diagrams—all in stock for immediate shipment.

ALLIED gives you every buying advantage: speedy delivery, expert personal help, lowest prices, assured satisfaction—plus the most liberal Time Payment plan in radio. Get the 1950 ALLIED Catalog—it will save you time and money. Send today for your FREE copy!

**ALLIED IS YOUR TELEVISION HEADQUARTERS**



You keep up with TV when you depend on ALLIED! Count on us for the latest releases and largest stocks of picture tubes, component parts, antennas and accessories—plus the latest in TV receivers, tuners and kits. If it's anything in TV—we have it in stock! So remember—for TV—it's ALLIED First!

## ALLIED RADIO

THE WORLD'S LARGEST RADIO SUPPLY HOUSE

*Everything in Radio, TV and Electronics*



**WORLD'S LARGEST STOCKS**

*Radio Parts Unlimited  
 Test Instruments—All Makes  
 Television & Home Radios  
 P. A. and Hi-Fi Equipment  
 Amateur Station Gear  
 Experimenters' Supplies*

**QUICK, EXPERT SERVICE**

Send for Radio's Leading Buying Guide

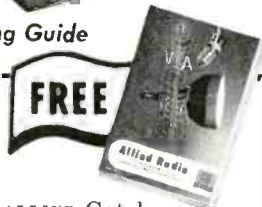

ALLIED RADIO CORP.  
 833 W. Jackson Blvd., Dept. 2-E-0  
 Chicago 7, Illinois

Send FREE 196-page 1950 ALLIED Catalog.

Name .....

Address .....

City ..... Zone ..... State .....

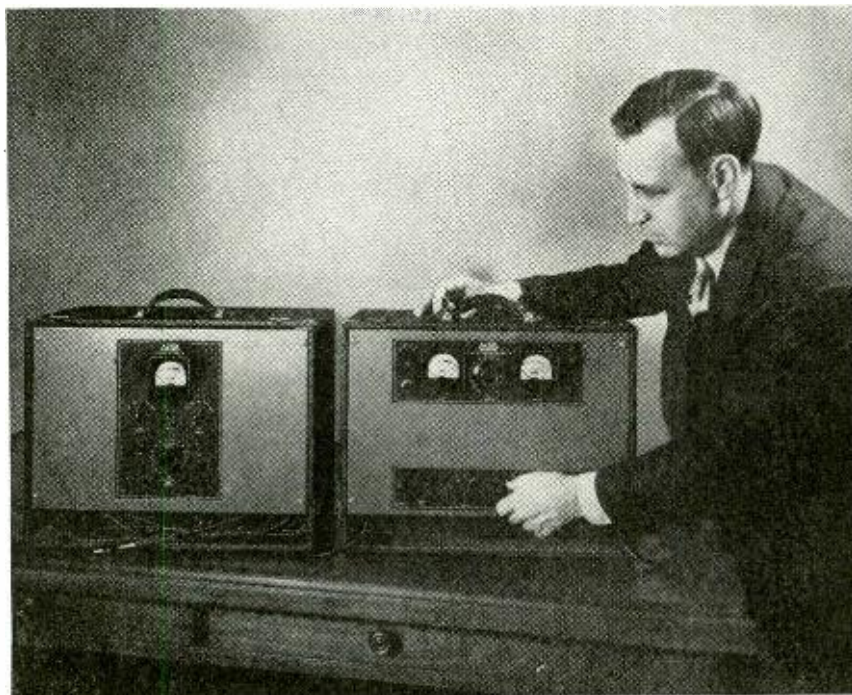

Altec-Lansing's John K. Hilliard adjusts their intermodulation test equipment.

# Intermodulation Distortion Tests

**How what is possibly the most serious form of audio-frequency distortion is detected and measured.**

By **CARL N. SHIPMAN\***

**T**HERE are three ways of measuring the distortion produced in an audio system. Distortion-factor meters and wave analyzers have been used for some time, but intermodulation analyzers are relatively new. Though no objective measurements have yet been devised that can predict accurately whether or not listeners will like the sound of a particular system (the listeners' ears are, after all, the final criterion), intermodulation tests usually seem to give better clues to hearer acceptance.

Distortion-factor meters are still

most common. A single-frequency sine wave is fed into the amplifier and the output is filtered so that the original frequency disappears. The remainder, which consists of any harmonics generated by the amplifier plus whatever noise is present, is measured. The fundamental output is also measured and the harmonics are then figured as a percentage of the fundamental. For good-quality systems 5% is often satisfactory, but nowadays high-precision professional equipment has only 2% or even less.

The wave analyzer works on the same principle; but instead of measuring all harmonics at once, it filters and

measures only one at a time, usually by beating an oscillator with the harmonic to be measured and passing the resultant beat frequency through a very selective filter. The advantage here is that the highly selective filter narrows the bandwidth measured so much that most of the noise is excluded. It also tells just which harmonics are most prominent, giving a clue to the fault, if any, in the system.

The trouble with harmonic measurement is that only distortion in the low-frequency half of the spectrum can be measured; if the fundamental is above the mid-frequency point, all the harmonics fall outside the audio band the equipment covers.

The intermodulation method of measuring distortion is based on the fact that the worst offense to the ears is committed when two or more different frequencies being amplified simultaneously interact due to some non-linearity in the amplifier. While pure harmonic distortion of a single tone merely creates additional frequencies which are exact multiples of the fundamental, interaction between two or more tones produces sum and difference frequencies which may be totally unrelated harmonically to the originals. The effect is a good deal worse than when some members of a musical ensemble play off pitch or wrong notes, destroying the harmonies or chords. Intermodulation measurements, therefore, usually approximate more closely the subjective reactions of a listener and are generally more useful than simple measurements of spurious harmonics.

The intermodulation method employs two tones: one of low frequency—between about 50 and 200 cycles, and one of considerably higher frequency—anywhere from about 1,000 cycles up. Both tones are fed to an amplifier, and an analyzer connected to the output measures the interaction between them.

## The signal generator

Fig. 1 is a block diagram of a typical intermodulation signal generator. The two oscillators produce sine waves, 60 and 2,000 cycles in this example. (The 60-cycle signal may be provided by the a.c. power line instead of an oscillator.) The two tones are combined in a network carefully designed for minimum distortion.

The resultant wave is shown in Fig. 1. It is a 2,000-cycle sine wave, with a 60-cycle sine wave as its axis of symmetry. As a more or less standard condition (though no genuine standards have yet been set) the voltage amplitude of the 60-cycle wave is four times that of the 2,000-cycle wave (12 db greater). With this relationship, the intermodulation distortion percentage is usually roughly four times as high as a straight harmonic distortion measurement would be on the same equipment. The exact ratio varies with the cause of distortion.

The output waveform of Fig. 1 illustrates what happens whenever two or more frequencies are combined—the

\* University of Hollywood

*..this letter speaks for itself!*

## Admiral Corporation

SERVICE DIVISION  
201 E. NORTH WATER STREET - CHICAGO 11 - TELEPHONE MOBILE #14322

Mr. Mel Bushing  
Simpson Electric Company  
5200 West Kinzie Street  
Chicago 44, Illinois

Dear Mel:

This is to tell you how delighted we are here at Admiral with the new Model 303 Simpson Vacuum Tube Volt-Ohmmeter. It certainly is a versatile instrument for television servicing.

The large meter is very legible, and yet the instrument itself is a compact size. I particularly like the AC voltage range, which is the widest I've ever seen on this type of instrument.

Our service engineers think you've done a good job on the Operator's Manual, too, because it is both complete and concise.

Of course, we've used the Simpson Model 260 Volt-Ohm-Milliammeter for years. The "303" is a fine companion instrument to the "260"

Congratulations!

Sincerely yours,

*M. J. Schinke*  
ADMIRAL CORPORATION  
M. J. Schinke  
National Service Manager

MJStar

WORLD'S LARGEST MANUFACTURERS OF RADIO PHOTOGRAPHS WITH AUTOMATIC SEC.  
18-19-20-21-22-23-24-25-26-27-28-29-30-31-32-33-34-35-36-37-38-39-40-41-42-43-44-45-46-47-48-49-50-51-52-53-54-55-56-57-58-59-60-61-62-63-64-65-66-67-68-69-70-71-72-73-74-75-76-77-78-79-80-81-82-83-84-85-86-87-88-89-90-91-92-93-94-95-96-97-98-99-100

# Model 303 VACUUM TUBE VOLT-OHMMETER

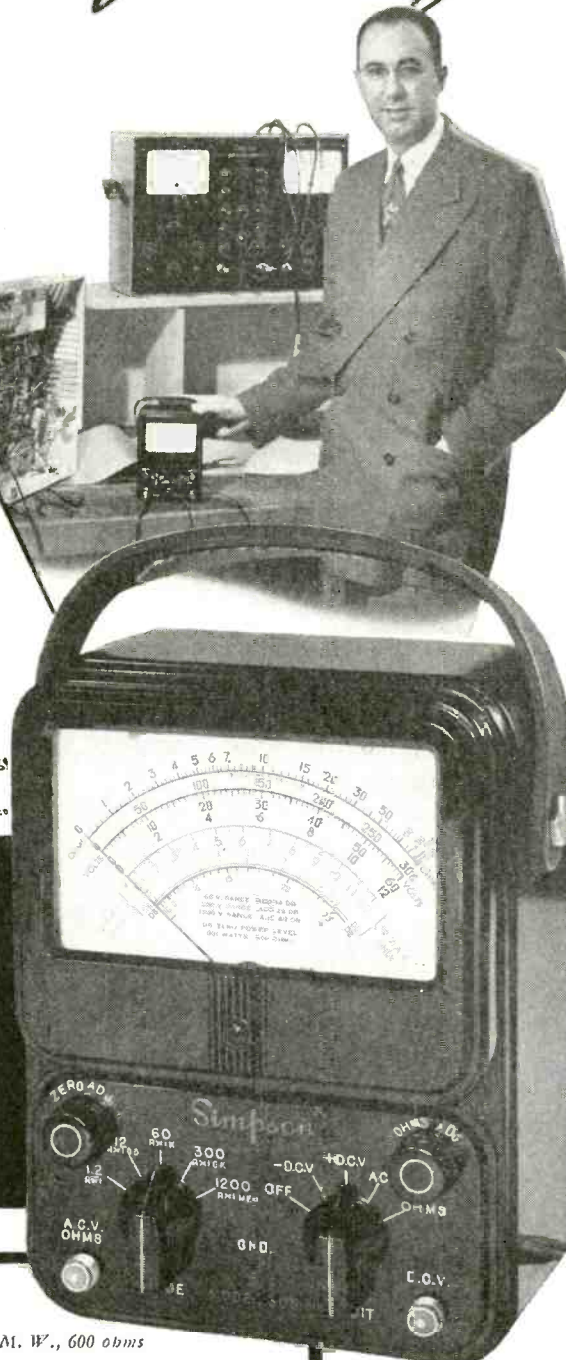

### SPECIFICATIONS

#### DC Voltage

Ranges 1.2, 12, 60, 300, 1200 (30,000 with Accessory High Voltage Probe)

Input Resistance 10 megohms for all ranges

DC Probe with one megohm isolating resistor Polarity reversing switch

Ohms Ranges 1000 (10 ohms center)  
100,000 (1000 ohms center)  
1 megohm (10,000 ohms center)  
10 megohms (100,000 ohms center)  
1000 megohms (10 megohms center)

#### AC Voltage

Ranges 1.2, 12, 60, 300, 1200  
Impedance (with cable) approx. 200 mmf shunted by 275,000 ohms

#### AF Voltage

Ranges 1.2, 12, 60  
Frequency Response Flat to 100,000 cycles

#### Decibels

Ranges -20 to +3, -10 to +23, +4 to +37,  
+18 to +51, +30 to +63

Zero Power Level 1 M. W., 600 ohms

#### Galvanometer

Zero center for FM discriminator alignment and other galvanometer applications

#### R. F. Voltage

(Signal tracing with Accessory High Frequency Crystal Probe)

Range 20 volts maximum  
Frequency Flat 20 KC to 100 M.C.  
105-125 V., 60 cycles

#### Size

5 1/4" x 7" x 3 1/4" (bakelite case). Weight: 4 lbs.  
Shipping Wt.: 6 1/2 lbs.

#### Dealer's Net Price

Model 303, including DCV Probe, ACV-Ohms probe and Ground Lead—\$58.75;  
Accessory High Frequency Probe, \$7.50;  
Accessory High Voltage Probe, \$14.85  
Also available with roll top case,  
Model 303RT—\$64.75

# Simpson ELECTRIC COMPANY

5200 WEST KINZIE STREET, CHICAGO 44, ILLINOIS • IN CANADA: BACH-SIMPSON, LTD., LONDON, ONTARIO

Phone: COLUMBUS 1-1221

lower ones act as axes for the upper ones, a single composite wave being formed. The shape, amplitude, and position of any portion of the wavetrain about the main a.c. axis depend on the original frequencies, amplitudes, and phase relations. To produce undistorted sound output, the composite wavetrain must reach the loudspeaker in exactly the same condition it assumes at the amplifier input. (The exception is that the ear will tolerate a rather large amount of phase change.)

As the composite generator output goes through the amplifier being tested, the low-frequency signal causes relatively large positive and negative grid-voltage excursions at each stage. If every tube operates on a linear portion of its transfer characteristic up to the maximum grid-voltage excursions in each direction, no distortion takes place. But if—as is always the case, since nothing is perfect—a nonlinear region is encountered during the swing in one or both directions, those alternations of the 2,000-cycle superimposed signal which occur while the tube is nonlinear will be either greater or smaller in amplitude than when the tube is operating linearly.

### Typical distortion

As an example, suppose one stage in the amplifier is a resistance-coupled 6J5 with a 50,000-ohm plate load resistor, a 50,000-ohm following grid resistor, and 1,000-ohm cathode-bias resistor. Plate supply voltage is 300. According to the resistance-coupled am-

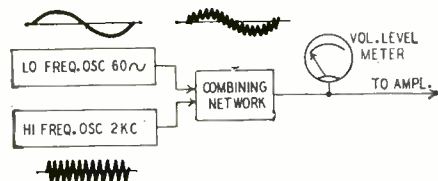

Fig. 1—The intermodulation signal generator combines two basic frequencies.

plifier charts in the RCA tube manual, voltage gain is 13 and maximum a.c. output voltage should be 41. Dividing 41 by 13, we find that maximum signal voltage at the grid should be 3.15.

Assume that the 3.15-volt input maximum is exceeded slightly. On positive input peaks the grid begins to draw current, flattening off the output wave to some extent. Each time the 60-cycle signal reaches a positive peak, therefore, the amplification of the tube effectively decreases somewhat and the 2,000-cycle alternations superimposed on the 90-degree point of the low-frequency wave have smaller amplitude.

It is likely, too, that negative 60-cycle excursions now take the tube into a nonlinear region, especially with such a low tube load resistance. At and about the 270-degree point of the low-frequency wave, therefore, given changes in grid voltage produce smaller changes in plate voltage and again amplification decreases. The result is reduced amplitude of the 2,000-cycle

alternations superimposed on the 270-degree region of the 60-cycle wave.

The composite wave now appears like A in Fig. 2. Comparing it with its counterpart in Fig. 1, the distortion is apparent in the reduced amplitude of the 2,000-cycle waves at the 60-cycle peaks.

Fig. 2 is a block diagram of an intermodulation analyzer. The amplifier output wave at A is fed first into a high-pass filter which removes the 60-cycle component from the composite signal. This leaves only the 2,000-cycle signal. Since the amplitude of the 2,000-cycle signal is no longer constant (because of the distortion in the amplifier), it appears at the filter output as a modulated wave (shown at B). Its amplitude is normal or maximum at the points which correspond to the 0-, 180-, and 360-degree regions of the filtered-out 60-cycle wave, and less than normal at the 90- and 270-degree points.

The wave at B is exactly like the familiar r.f. modulated wave (except, of course, for the actual frequency, which is 2,000 cycles) and can be detected and measured in the same way.

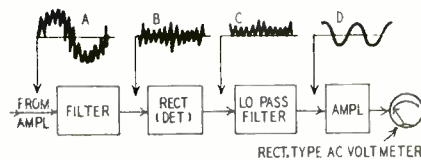

Fig. 2—The analyzer filters the output signal, detects and measures distortion.

It is first rectified (detected) to yield the d.c. wave at C. Then it is fed through a low-pass filter to remove the 2,000-cycle pulsations. The low-frequency modulation envelope remains at D.

Note one important point. The remaining modulation envelope is *not* the original 60-cycle signal. It is the change in amplitude of the 2,000-cycle signal produced by the 6J5 nonlinearities. Since the amplitude was changed twice during each low-frequency cycle (once by the tube's drawing grid current and once by the negative excursion into a nonlinear transfer region), the modulation envelope at D is twice the original low frequency or 120 cycles. If either the negative or positive 6J5 grid excursion alone had caused nonlinearity, that is, a change once per low-frequency cycle, the wave at D would be 60 cycles. Its shape is usually not sine, either, depending on how abruptly the 6J5's characteristic departed from linear.

The wave at D in Fig. 2 is produced solely by amplifier nonlinearity, which affected the relationship between two frequencies. If the amplifier were linear, the 2,000-cycle signal would have remained constant in amplitude as it was originally, and detection of a wave at B would have resulted in pure d.c. Obviously, then, the amplitude of the wave at D is a direct indication of the amount of distortion present. It is measured by an ordinary rectifier-type volt meter. In some instruments, the circuit is arranged so that the operator

can tell whether distortion is greater in the negative or positive direction.

The percentage of intermodulation is equal to the modulation percentage of the "carrier" wave at B. With the analyzer calibrated to present a fixed level to the detector, the meter may be marked directly in percent.

When citing intermodulation figures, the test conditions should be specified. The two frequencies should be given, as well as the amplifier output level. For greatest precision, the amplifier input level and the amplitude relationship of the two frequencies should also be mentioned. Measurements should be made with several sets of frequencies, as the distortion varies somewhat.

An amplifier which has low harmonic distortion ordinarily shows low intermodulation as well. Intermodulation results usually agree more closely with listening tests, however, and give a better indication of performance at high frequencies.

The percentage figure for intermodulation is always higher than that for harmonic distortion, which is why some manufacturers feel it unwise to publish it. A more valid reason is that standards for intermodulation testing have not yet been agreed on, and this may make interpretation difficult.

### REFERENCES:

- Frayne and Wolfe, *Elements of Sound Recording*, John Wiley and Sons, Inc., New York, 1949.  
G. W. Read and R. R. Scoville, "An Improved Intermodulation Measuring System," *Journal of the Society of Motion Picture Engineers*, February, 1948.  
"Proposed Standards for the Measurement of Distortion in Sound Recording," *Journal of the Society of Motion Picture Engineers*, November, 1948.

### NOVEL SPEAKER CONNECTION

Two (or any multiple of two) speakers may be connected on this circuit to the output of two amplifiers while preventing power from being transferred from one amplifier to the other. The circuit is particularly useful in elaborate public address and paging systems. In such installations, one amplifier may be used for announcements

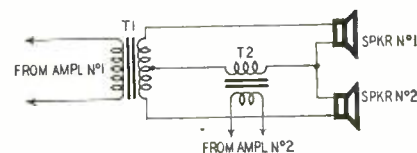

Hybrid connection for two speakers.

and another for paging. In a typical airport installation the speakers common to both amplifiers would be in the waiting room or at the loading gate. Individual speakers for the paging and announcing amplifiers would be located in restrooms, cafeterias, and on the observation deck.

The secondary impedance of T1 should be twice the impedance of either speaker, and the impedance of T2 one-half the impedance of a single speaker.

—Charles A. Kuopp



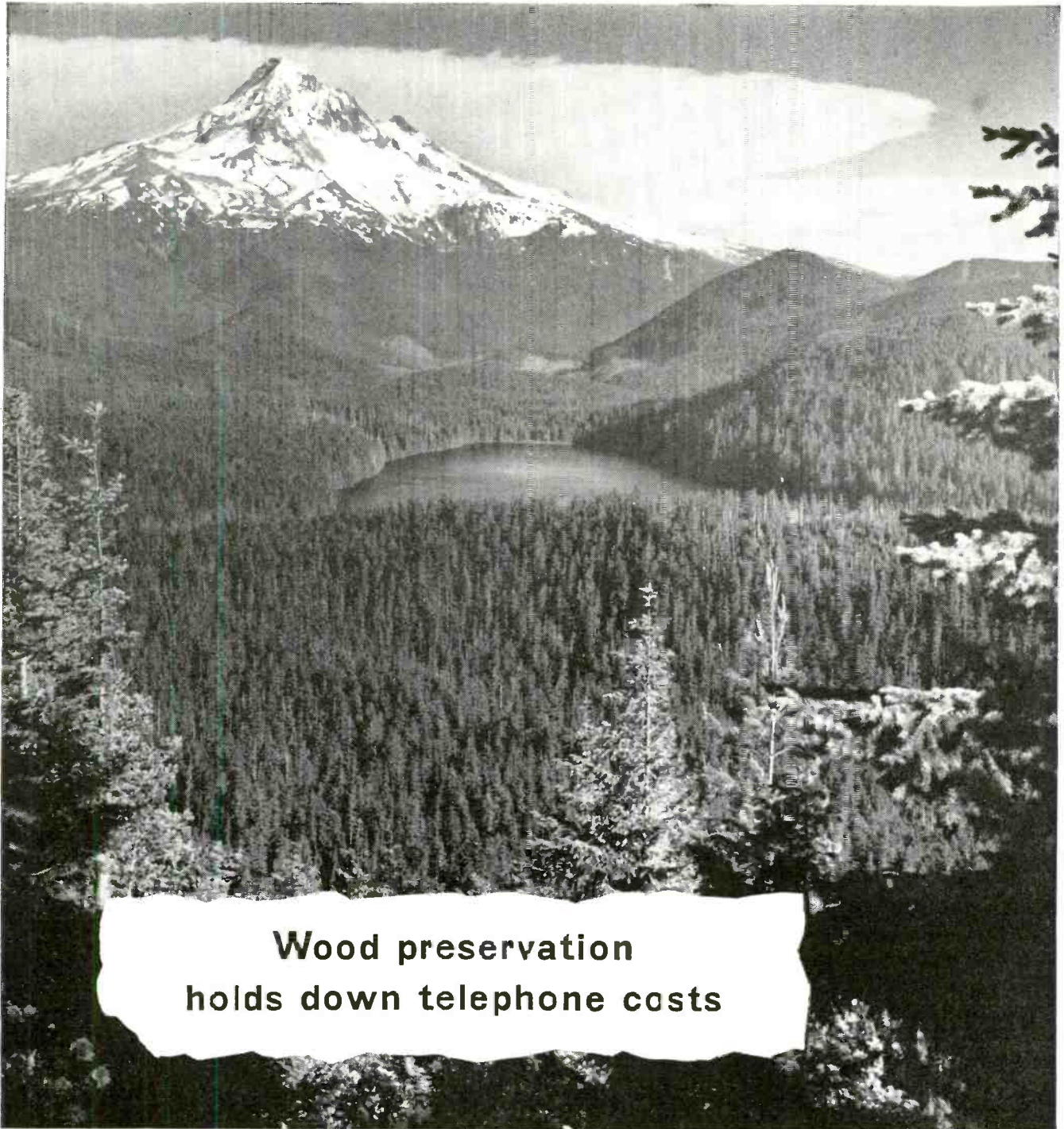

## Wood preservation holds down telephone costs

Poles are a substantial part of the plant that serves your telephone; making them last longer keeps down repairs and renewals that are part of telephone costs. So Bell Laboratories have long been active in the attack on wood-destroying fungi, the worst enemies of telephone poles.

Better, cleaner creosotes and other preservatives have been developed in co-operation with the wood-preserving industry. Research is now being carried out on greensalt—a new, clean, odorless

preservative. Even the products of atomic energy research have been pressed into service—radioactive isotopes are used to measure penetration of fluids into wood.

Treated poles last from three to five times as long as untreated poles. This has saved enough timber during the last quarter century to equal a forest of 25,000,000 trees. More than that, wood preservation has enabled the use of cheaper, quickly growing timber instead of the scarcer varieties.

This and other savings in pole-line

costs, such as stronger wires which need fewer poles, are some of the reasons why America's high-quality telephone service can be given at so reasonable a cost. It is one of today's best bargains.

**BELL TELEPHONE  
LABORATORIES**



*Exploring and Inventing, Devising and Perfecting, for Continued  
Improvements and Economies in Telephone Service.*

# 2 Pages of TEST EQUIPMENT at prices every serviceman can afford!

## OUR POLICY

**MONEY BACK?** Every unit we advertise is offered on a strict "money-back-if-not-satisfied-basis". No if's—no but's—no maybe's. If you are not

completely satisfied after a 10 day trial—return for complete refund. No explanation—you are the sole judge. Plain enough?

**GUARANTEE?** Every unit sold by us is covered by a one year guarantee.

**KITS?** We have discontinued advertising Test Equipment in kit form. After handling kits for some months, we have come to the conclusion that it is impractical to successfully complete instrument

kits at home without the expensive calibration standards and other equipment available when instruments are factory produced.

# TUBE TESTERS

THE NEW MODEL 247



Check octals, loctals, bantam jr., peanuts, television miniatures, magic eye, hearing aids, thyratrons, the new type H.F. miniatures, etc.

**Features:**

★ A newly designed element selector switch reduces the possibility of obsolescence to an absolute minimum.

★ When checking Diode, Triode and Pentode sections of multi-purpose tubes, sections can be tested individually. A special isolating circuit allows each section to be tested as if it were in a separate envelope.

★ The Model 247 provides a supersensitive method of checking for shorts and leakages up to 5 Megohms between any and all of the terminals.

★ One of the most important improvements we believe, is the fact that the 4-position fast-action snap switches are all numbered in exact accordance with the standard R.M.A. numbering system. Thus, if the element terminating in pin No. 7 of a tube is under test, button No. 7 is used for that test.

Model 247 comes complete with new speed-read chart. Comes housed in handsome hand-rubbed oak cabinet sloped for bench use. A slip-on portable hinged cover is indicated for outside use. Size: 10 3/4" x 8 3/4" x 5 3/4". ONLY

**\$29.90**  
NET

SUPERIOR'S NEW MODEL TV-10



**Specifications:**

★ Tests all tubes including 4, 5, 6, 7, Octal, Lock-in, Peanut, Bantam, Hearing-aid, Thyatron, Miniatures, Sub - Miniatures, Novals, etc. Will also test Pilot Lights.

★ Tests by the well-established emission method for tube quality, directly read on the scale of the meter.

★ Tests for "shorts" and "leakages" up to 5 Megohms.

★ Uses the new self-cleaning Lever Action Switches for individual element testing. Because all elements are numbered according to pin-number in the RMA base numbering system, the user can instantly identify which element is under test. Tubes having topped filaments and tubes with filaments terminating in more than one pin are truly tested with the Model

TV-10 as any of the pins may be placed in the neutral position when necessary.

★ The Model TV-10 does not use any combination type sockets. Instead individual sockets are used for each type of tube. Thus it is impossible to damage a tube by inserting it in the wrong socket.

★ Free-moving built-in roll chart provides complete data for all tubes.

★ Newly designed Line Voltage Control compensates for variation of any line voltage between 105 Volts and 130 Volts.

The Model TV-10 operates on 105-130 Volt 60 Cycles A.C. Comes housed in a beautiful hand-rubbed oak cabinet complete with portable cover.

**\$39.50**  
NET



SUPERIOR'S new model TV-30

## TELEVISION SIGNAL GENERATOR

ENABLES ALIGNMENT OF TELEVISION I. F. AND FRONT ENDS WITHOUT THE USE OF AN OSCILLOSCOPE!

**FEATURES**—Built-in modulator may be used to modulate the R. F. Frequency also to localize the cause of trouble in the audio circuits of T. V. Receivers.

Double shielding of oscillatory circuit assures stability and reduces radiation to absolute minimum. Provision made for external modulation by A. F. or R. F. source to provide frequency modulation.

All I. F. frequencies and 2 to 13 channel frequencies are calibrated direct in Megacycles on the Vernier dial. Markers for the Video and Audio carriers within their respective channels are also calibrated on the dial.

Linear calibrations throughout are achieved by the use of a Straight Line Frequency Variable Condenser together with a permeability trimmed coil.

Stability assured by cathode follower buffer tube and double shielding of component parts.

**SPECIFICATIONS**—Frequency Range: 4 Bands—No switching; 18-32 Mc., 35-65 Mc., 54-98 Mc., 150-250 Mc.

Audio Modulating Frequency: 400 cycles (Sine Wave). Attenuator: 4 position, ladder type with constant impedance control for fine adjustment. Tubes Used: 6C4 as Cathode follower and modulated buffer, 6C4 as R.F. Oscillator, 6SN7 as Audio Oscillator and power rectifier.

Model TV-30 comes complete with shielded co-axial lead and all operating instructions. Measures 6" x 7" x 9". Shipping Weight 10 lbs.

**\$29.95**  
NET

— — — TO ORDER—USE RUSH ORDER FORM ON NEXT PAGE — — —

**GENERAL ELECTRONIC DISTRIBUTING CO.**

98 PARK PLACE  
DEPT. RC-5  
NEW YORK 7, N. Y.



# UNUSUAL TECHNIQUES IN SOUND RECORDING



By

RICHARD H. DORF

Recording room is in two parts separated by glass so that at least two operations can be carried on at once without having conflicting speakers going. All amplifying equipment is in 6-foot racks for maximum flexibility. Any of the dubbing tables or studios can be connected to any tape or disc machine.

**L**IKE many RADIO-ELECTRONICS readers, I have been greatly interested in amateur sound recording for a long time. When I had an opportunity recently to spend the best part of a day at Reeves Sound Studios in New York, I expected to feel very much like a spectator on an NBC studio tour who appreciates the intricate and efficient setup but finds nothing that is likely to have any real relation to his own work.

That isn't what happened. I saw practices, tricks, and techniques, many of which you or I can duplicate. I then realized that recording can be combined with imagination and ingenuity to produce highly distinctive work, and save time and labor.

As a very simple example, the playback tables used for dubbing are started by a switch on the recorder console permitting one man to do a dub job without having to run back and forth and make long run-in grooves. And even while I was sitting there, one engineer thought of an improvement on that—a spring and solenoid arrangement that eliminates even the second or so delay while the table gets up speed!

Reeves is the largest independent sound recording installation on the Eastern seaboard. Occupying a five-story building, it not only does straight

sound recording, but has a big hand in producing sound tracks for motion pictures—television commercials and shorts, government training and information films, almost every conceivable type of movie except regular Hollywood features.

Today over half of the studio's activity is film work, but making discs of all kinds is a very important part of each day's work. The disc recording room (see photos) is a separate entity to which programs are fed from any of the five separate studios in the building. Here are located two tape recorders, four disc recorders, four playback tables, three 6-foot racks full of amplifying, switching, and control equipment, and miscellaneous other devices.

### Why tape?

This month's cover is filled mainly with a tape recorder (we'll consider the young lady operator merely as a control device, if you don't mind) and you may wonder what a tape recorder has to do with a disc story. The answer is one reason for the musical perfection of many long-playing records.

No orchestra, quartet, or pianist ever has the good luck to turn in a full 40- or 50-minute performance with every note just the way it ought to be. The first ten minutes may be perfect,

but one player may "hit a clinker" in the middle of the 339th bar and the tempo may be off just a shade at the start of the second movement. During a concert-hall performance, these things are quickly forgotten if the work as a whole is good. But a recording will be played back time and time again—and the "clinker" gets worse every time! In the "old days" a bad note during the recording meant doing over again at least one side of a disc, and the work had to be done in segments of no less than about 3 or 4 minutes—the time recorded on one side of a disc.

Then the tape recorder bowed in. The performance is recorded on tape, not on discs. If the conductor doesn't like the way things are going, he stops the orchestra and starts again a couple of bars before the unsatisfactory point. If he isn't sure, he stops and listens to the tape, then makes up his mind. (You can't listen to a disc, then use it as a master for pressing.) Or he may repeat a portion of the music at slightly different tempo, then decide later which is preferable.

The whole performance may be recorded in bits and pieces and not necessarily in the correct sequence. Just as long as all the music gets on the tape somehow and as long as each part has been given a good performance at least once, the job is done. (Cont on p. 62)

# Order your **EICO** Test Instrument Kits NOW

## SAVE UP TO 50%

by building your own precision laboratory test instruments!  
Easy to build in one evening — They last a lifetime

from  
**ALLIED**

**\$19<sup>95</sup>**



### SIGNAL GENERATOR

**Model No. 320-K.** An invaluable test unit for service, laboratory and school use. Highly stable Hartley oscillator has range of 150 kc to 102 mc with fundamentals to 34 mc. Ideal for quick alignment of FM-AM receivers; provides TV marker frequencies. Also supplies 400-cycle audio output from a Colpitts oscillator. Audio oscillator voltage can be used for testing distortion in audio equipment, bridge measurements, etc. Complete with tubes, portable case, etched panel, all parts, knobs, wire, shielded cable, instructions, diagrams, and operating manual. Size: 10 x 8 x 4 3/4". For 110-120 volts, 60 cycle AC. Shpg. wt., 10 lbs.

83-154. Only..... **\$19.95**

**\$23<sup>95</sup>**



### VACUUM TUBE VOLTMETER

**Model No. 221-K.** An easy-to-build, sensitive VTM for making measurements in high-resistance circuits. 15 different ranges, with DC input resistance of 26 megohms. 4 1/2" meter is protected against burnout. Includes zero center for alignment of FM and TV discriminators. Double-triode balanced bridge circuit assures top stability. Ranges: AC-DC volts, 0-5-10-100-500-1000; resistance, 0-1000 ohms and 0-1-10-100-1000 megohms. With tubes, all parts, portable case, etched panel, wire, instructions, diagrams and operating manual. Size: 6 x 9 1/2 x 5". For 110-120 volts, 60 cycle AC. Shpg. wt., 10 lbs.

83-152. Only..... **\$23.95**

**\$39<sup>95</sup>**



### NEW 5-INCH OSCILLOSCOPE

**Model No. 425-K.** A sensational scope with all new features at amazing low price! With Push-Pull deflection! A precision instrument for TV, FM and AM alignment. Extra sensitive: .05 to .1 volts per inch. Wide range, flat from 5 cps to 500 kc, useful to 2 1/2 mc. Wide range sweep circuit from 15 cps to 75,000 cps. Direct connection to plates of CR tube available at rear of cabinet. Complete with tubes (3-6SN7, 2-6J5, 5BP1, 2-5Y3 rect.), portable case, etched panel, all parts and knobs, wire, instructions, diagrams and operating manual. Size: 8 3/4" x 13 1/4" x 17" deep. For 110-120 volts, 60 cycle AC. Shpg. wt., 30 lbs.

83-155. Only..... **\$39.95**

**\$14<sup>95</sup>**



### VOLT-OHM-MILLIAMMETER

**Model No. 511-K.** A pocket-size reliable VOM. 3" meter. Germanium crystal for AC. Ranges: DC v., 0-5-50-250-500-2500; AC and output v., 0-10-100-500-1000; DC current, 0-1-10-100 ma. 0-1-10 amps; res., 0-500-100,000 ohms, 0.1 meg; decibels, -8 to +55. Complete kit, ready to assemble. Shpg. wt., 3 1/2 lbs.

83-153. Only..... **\$14.95**

### SWEEP SIGNAL GENERATOR

**Model No. 360-K.** For visual alignment at TV and FM frequencies between 500 kc and 228 mc. For use with any scope. Sweep width variable from 0-30 mc. Crystal marker with variable amplitude. Provision for injection of external marker. Phasing control. Vernier dial calibrated in frequencies. Complete with tubes (2-6C4, 1-12AU7, 6X5GT rect.), all parts, shielded cable, portable case, panel, wire, instructions and operating manual. Less crystal. Size: 10 x 8 x 6 3/4". For 110-120 v., 60 cycle AC. Shpg. wt., 12 lbs.

83-159. Only..... **\$29.95**

**\$29<sup>95</sup>**



### WE STOCK ALL EICO EQUIPMENT

- Model 145-K Multi-Signal Tracer. 83-158. Only..... **\$18.95**
- Model P-75K High-Frequency Probe Kit. 83-156. Only.. **3.75**
- Model P-76K H-F Probe Kit. 83-157. Only..... **3.75**
- Model HVP-1 High Voltage Probe. 83-160. Only..... **6.95**

(All Prices Net F. O. B. Chicago)

**FREE** SEND FOR YOUR 196-PAGE 1950 **ALLIED CATALOG**  
Radio's Leading Buying Guide



Get the only complete Radio Buying Guide in the field—the one book that fills all of your Radio, Television and Electronic supply needs! Get every buying advantage at **ALLIED**—world's largest stocks of quality equipment at lowest money-saving prices—speedy, expert shipment, personal attention, complete satisfaction on every order. Get your **FREE ALLIED Catalog** today!

**ALLIED RADIO**

ALLIED RADIO CORP., Dept. 2-EE-0  
833 W. Jackson Blvd., Chicago 7, Illinois

Ship the following EICO equipment:.....

Enclosed \$.....  Full Payment  
 Part Payment (Balance C.O.D.)  
 Send FREE 196-Page ALLIED Catalog

Name.....

Address.....

City..... Zone..... State.....

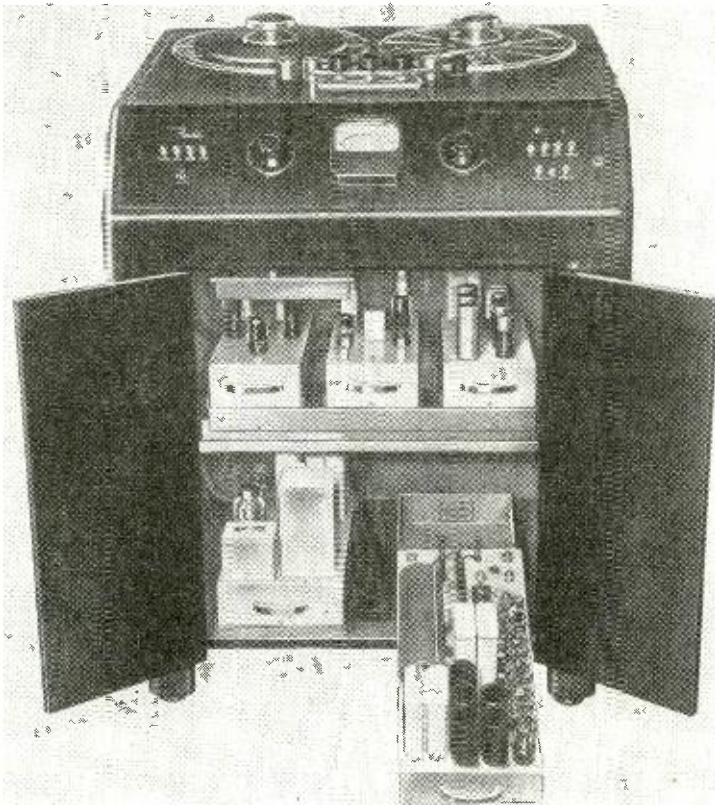

The Fairchild tape recorder produces higher-quality sound than most of the best disc recorders. Amplifiers and relays are housed in the console cabinet. The recorder plays for one hour. Reeves engineers use plastic tape because its thickness is more uniform than that of paper tape. Speed is 30 inches a second.

Then the conductor gets together with the engineers. They listen to the tape with a score in one hand and a pair of scissors in the other. They clip out the best performances of each part of the music—a few bars here, per-

haps a single high trumpet note there. Then they splice it all together and throw away the second-rate bits. The result is a complete performance, each note of which is played at its best. The last step is to dub the tape to an LP



Engineer monitors the cutting of an LP with one hand on pitch control and his eyes on a cue sheet which indicates when the loud and soft passages will appear.

master. Mercury records are made this way at Reeves and you can hear the result yourself if you happen to own a Mercury LP—one that was made here, not dubbed from European masters. RCA (and probably others) uses tape for its classical master records.

One disadvantage is inherent in LP records—the sound level fed to the cutter must be lower than with standard records to avoid overcutting (having the stylus cut through into adjacent grooves during loud peaks). Another disadvantage common to all discs is reduced range between the loudest and softest sounds that can be recorded—for the same reason, even with standard groove spacings.

Bob Fine's invention of the margin control technique has almost completely cured these troubles. It's very close to one of those why-didn't-I-think-of-it-myself ideas. The only time overcutting is a danger is during loud passages, and then only because the adjacent groove is so close.

The answer is to make the next groove not so close! So the control engineer *varies the pitch*—the number of grooves per inch—during the recording, rather than the sound level. In soft passages, the grooves are made very close together to get the maximum playing time. Just before a loud passage, the distance is increased to allow for the greater stylus swing. The total pitch range is from about 320 lines per inch for very soft music to approximately 160 lines for the loudest parts of the music.

The *depth* of the cut also must be varied so that on the loud passages, when the groove swings are wider, the playback stylus will not jump out. The engineer does this with a knob, not by manually adjusting the cutter. The depth control device is still in the developmental stage and details are not available.

The drawings show in a simple way how the pitch of the Fairchild recorder, which Reeves uses, can be varied continuously without changing the lead screw or any pulleys. A flat disc is driven by the motor. Between it and the sleeves fastened rigidly to the right end of the feed screw is a ball bearing which contacts both disc and sleeve. When the disc rotates, the motion is transmitted through the ball to the sleeve, which then rotates axially, carrying the feed screw, which is fixed to the sleeve, with it.

By simple mechanical law, the speed of the feed screw depends on the position of the ball. The direction in which the feed screw rotates depends on whether the ball is to right or left of the center of the disc.

The top-view drawing shows how the position of the ball is controlled. The ball is enclosed in a metal frame (without top or bottom, of course). The frame is moved right and left by a knob, taking the ball with it. A vertical metal plate under the knob is calibrated in lines per inch with separate

scales at right and left for outside-in and inside-out.

Interestingly, this scheme was devised long before microgroove records were on the market. It just happened to be adaptable to making LP's, the only change necessary being the addition of calibration marks on the metal plate. The possible pitch variation is from 80 to a theoretical infinity. Actual records have been made at pitches as high as 500 lines.

The volume of work at the studios surprised me. The recording room is in business approximately 90 hours a week making discs for Mercury and other independent companies; radio commercials (including jingles, of course); sound effects for radio programs; frequency test records; and programs for the Department of State and other independent producers.

One of the most interesting and unusual discs was made on special order for an ingenious householder who wanted a burglar alarm. The burglar's entrance turns on a record

set the Fairchild recording table to the 33 1/3-r.p.m. position. The new frequency is generated by a Hewlett-Packard a.f. oscillator and stepped up by a high-power audio amplifier with 845's in the output stage.

Just about all the recording equipment in use at Reeves is made by Fairchild. The tape recorders are in console cabinets with amplifying equipment inside. Some of it can be seen in the cover photo and more in the picture on these pages. Pushbuttons and signal lights give quick and easy control, essential for accurate recording of tricky material. Response is flat within 1 db from 50 to 15,000 cycles.

While I was at the studio, the engineer's made an LP disc master from a tape of piano music. The record was an instructional one, designed to show how the piano developed, and several early and modern pianos and harpsichords were recorded on it. The last selection was played by Edith Weiss-Mann, world-famous harpsichordist, on four different instruments, one quarter

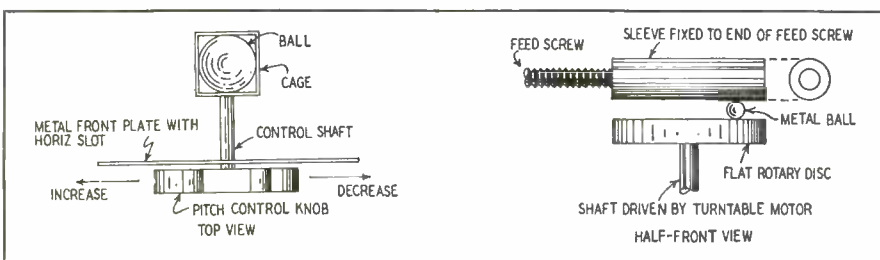

How pitch is varied continuously in the Fairchild disc recorder. Precision ball couples rotary disc driven by motor to feed screw sleeve. Position of ball determines pitch and direction. The knob and cage move ball to the right or left.

player which sends the sound of a barking dog to a loudspeaker, then generates a subaudible tone which operates a relay to turn on the lights.

Many recorded slide lectures are made, with an 8-kc tone on the disc to trigger the slide projector automatically at the proper places.

**A three-speed dub**

Children like stories with elves or fairies, and Golden records try to satisfy them. But the tiny elfin voice is too high for any human to produce. Here's how Reeves did it.

The orchestra was recorded at 78 r.p.m. It was played back at 33 1/3 r.p.m. and the voice sang with the playback. This combination was fed to a recorder at 33 1/3 r.p.m. When the result was played back at 78 onto the final master, the orchestra was returned to its original pitch, but the voice pitch was very much higher—and sounded just like the elf the children want. In another, similar record, two elfin voices were wanted, and their pitches had to be different so they could be told apart. That was done by using 33 1/3 for one voice and 45 r.p.m. for the other.

At the moment, Reeves is the only studio other than RCA making 45-r.p.m. masters. To get the new speed, they change the power-supply frequency from 60 to 81.008 cycles and

of the piece on each instrument. Then the four strips of tape were spliced together and played back. The change of instruments took place, not in musical pauses, but right in the middle of the selection—when the music was going fast. But so perfect was the cutting and splicing job that there was not the slightest falter in tempo when the instruments changed. If Bob Fine, Reeves' chief engineer and inventor of most of the special techniques and gadgets, had not given me his word that it was a splice job, I would have been absolutely sure that four different players had made the recording at the same time.

The Fairchild disc recorders have a frequency response of ±2 db to 8 kc, but they are cut off at around 6 kc when making LP's. Fine says the usual playback stylus simply will not track anything higher than that, especially toward the inner diameter of a fine-groove disc, and he can see no reason why higher frequencies should be put on the record at all. According to him, "psychological" wide range is much more important than what the meter says. If the recording is made in a suitably reverberant studio or hall, if the microphone placements are correct, if there is little harmonic or intermodulation distortion and record noise, the ear thinks the recording is beautiful.

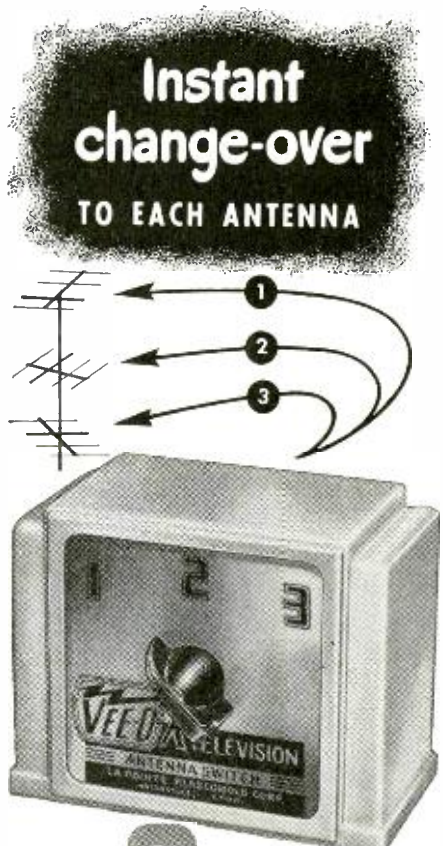

**Vee-D-X 3 WAY ANTENNA SWITCH**  
\$4.95 list

Separate lead-ins on multiple antennas are no problem with the new VEE-D-X antenna switch. Just turn the knob, and you can change over instantly from one antenna to another. Eliminates entirely the fuss and bother of changing transmission lines every time a different antenna is used. Very useful for T V Dealers when demonstrating more than one receiver from a single antenna.

Here are the features that make the VEE-D-X Antenna Switch the finest available:

- Specially designed switch prevents leakage.
- Furnished in attractive ivory plastic case with satin finished aluminum face.
- Terminal strip accommodates three separate lead-ins as well as output line to receiver.
- Easy to install.
- Lead-ins attach to rear and are hidden from view.



LA POINTE-PLASCOMOLD CORP., 1 Unionville, Conn.  
Please send me further information about your TV antennas and accessories.

Name .....  
Address .....  
City ..... Zone ..... State .....

# NEW TELEKITS

NOW **49<sup>95</sup>**

Jobbers: Write for Confidential Price Information

NEW  
TELEKITS

12-B \$79.95  
10-B \$69.95  
8-B \$54.50  
7-B \$49.95  
LESS TUBES



Sparkling new Telekit 12-B has 90-inch screen. Brand new compact lay-out has video tube mounted on chassis. Big illustrated easy-to-follow instruction book guides you step by step through easy assembly. No special knowledge of television is required. All you need is a soldering iron, pliers, and screw driver. 12-B kit can be used with 16 inch tubes. Telekit cabinets \$24.50 to \$35.00. Satisfactory Telekit performance guaranteed by Factory Service Plan. 12-B Telekit (90 inch screen) \$79.50. 10-B Telekit (61 inch screen) \$69.95. 8-B Telekit (48 inch screen) \$54.95. 7-B Telekit (25 inch screen) \$49.95. Write for catalogs listing Telekits and TV accessories.

TELEKIT  
BOOSTER  
\$12.95

This Telekit booster will bring in TV signals bright and clear in the fringe areas. Will give brilliant performance with any receiver. NOT A KIT.

Completely assembled. With tubes. Works with Telekit or any TV receiver.



13  
CHANNEL  
TUNER  
\$12.95

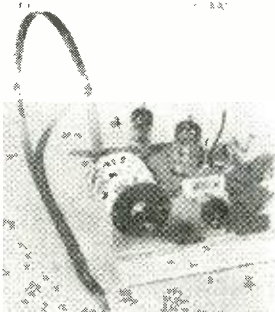

This compact front end has a stage of RF for extra distance. Made to conform with Telekit or any TV set having a video I.F. of 25.75 Mc. Complete with tubes, pre-wired, pre-assembled. Only four connections to make.

Write for catalog of Telekit antennas, boosters, television kits, tuners, television parts and tubes.

**TELEKIT**  
ELECTRO-TECHNICAL INDUSTRIES  
1432 N. BROAD ST., DEPT. B PHILADELPHIA 21 PA.



Even outside the studio, with portable equipment, standards must be kept high.

# Recording For Profit

by FRANK E. FLEMING

RECORDING studios today are in the position photographic studios found themselves when the camera first became practical in the hands of the layman. With the advent of successful home recorders, recording studios are competing with amateurs. Does that mean recording will be confined to a half-hearted sideline in the hands of radio stores? We think not. It does mean that recording studios, like photographic studios, must be able to turn out a better job than the amateur. Some recording studios are doing a professional job; many more could, following certain principles of operation.

As we see it, three requisites are demanded: service, a good-looking product, and a good-sounding product.

The word "service" covers the entire job. It refers to the friendly approach, the effort to put the client at ease, care in musical balance, care in adjustment of the recorder, care in making the record, and a frank warning of the limitations of acetate recordings. These are important ingredients of a successful recording business.

We make a practice, when arranging recording appointments, to advise the client that the job will take considerably longer than actual cutting time of the record: we ask him to time his material carefully. If, as sometimes happens, the recording runs overtime and must be stopped before completion, the onus is on the customer.

We also find out what type of machine the record will be played on. If it is to be used on an old-fashioned acoustic machine with heavy tone arm (there are still considerable numbers in use),

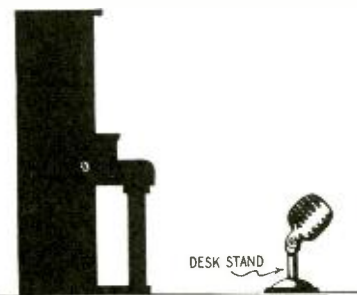

Fig. 1—Microphone on the floor is best for picking up certain kinds of pianos.

RADIO-ELECTRONICS for



we frankly advise against making a record. Only dissatisfaction will result from playing an acetate disc on such a machine, and the customer will feel cheated. Oddly enough, most such people if forewarned, will find a friend with a modern record player, and will make the record anyway. Whatever the outcome, we have kept our reputation intact.

We have already warned our client that the job will take more time than the actual cutting; so we do not have to worry about taking up his time. On the contrary, he is usually pleased at the importance we place on making his record. The extra time is consumed mainly in achieving a correct microphone placement. In speech recording the matter is comparatively simple; in vocal or instrumental work the job can become complicated.

**Microphone placement**

Even the balance between a single voice and piano requires care, and experimenting with microphone position will pay off. To some extent, balance is a matter of personal preference, but it depends also on the type of voice. Fairly heavy accompaniment can often cover vocal flaws without actually obscuring the voice. It is not advisable to ask either vocalist or pianist to perform more loudly or more softly than they do normally. The more comfortably the artists can perform, the better the results.

This rule does not necessarily apply to piano solos, where the damper ("loud") pedal should be used more sparingly than in ordinary circumstances. If the player finds the "pedal habit" hard to break, however, it is not wise to press the point. In a piano solo, microphone placement can make a tremendous difference to the results. We have found that, in many rooms improperly treated acoustically, a microphone on a desk stand, placed on the floor as in Fig. 1, gives best results. In any case, only experimentation will determine best placement.

Vocal quartets can be exasperating. If voices blend and balance properly to begin with, a microphone placed a few feet in front of them will usually do the job. If some voices predominate, special mike positioning will be necessary. Having achieved correct balance, you may find it disappears in the next line of the song. Nothing can be done, because the singers themselves cannot keep their voices balanced. If critical remarks are passed when the record is played back, it is well to point out the spots where balance is o.k., and indicate diplomatically that the fault lies, not in the recording, but in the quartet.

Obtaining correct balance on an orchestra is often more difficult, but worth the taking of infinitely greater pains. If each member of the orchestra can hear his own instrument on the finished record, chances are he will have a duplicate made for himself. If recording from a band-shell, with little opportunity for rearranging instruments, a great deal of ingenuity may be



**FOR . . .**

- RADIO SERVICING
- TELEVISION SERVICING
- AMATEUR RADIO
- HIGH FIDELITY SOUND

Stancor transformers are original components in thousands of radio and television receivers made by the biggest names in the industry—they have to be good to be specified by critical design engineers and value-conscious purchasing men!

Why shop around? Specify Stancor for your replacement work. You will get a dependable, honestly-rated transformer. You'll cut down on expensive call-backs. You will keep your customers.

FREE For complete, accurate specs and prices of the complete Stancor stock line, write for your copies of the literature illustrated above. Just ask us for the Stancor transformer library. Standard Transformer Corporation, 3592 Elston Avenue, Chicago 18, Illinois.

*It's Stancor*  
**FOR**

**TRANSFORMERS**

**MOST COMPLETE LINE IN THE INDUSTRY**



Over 43,000 Technicians Have Learned  
**HOW TO GET THE MOST OUT OF BASIC TEST EQUIPMENT**  
Why Not You, Too?

**SERVICING by SIGNAL SUBSTITUTION**  
A BEST SELLER FOR OVER 9 YEARS! (NEW, UP-TO-DATE, 11TH EDITION)

The Simple, Modern, Dynamic Speed Approach To Receiver Adjustment and Alignment Problems, AM-FM-TV.

- Nothing complex to learn
- Universal — non-obsolete
- No extra equipment to purchase
- Employs Only Basic Test Equipment

Ask for "S.S.S." at your local Radio Parts Jobber or order direct from factory.

**only 40¢**

100 pages. Invaluable information that will help you re-double the value of your basic test equipment.

PRECISION APPARATUS COMPANY, INC. • 92-27 Horace Harding Blvd., Elmhurst 4, N. Y.

# PREMIUM QUALITY at NO EXTRA COST

Sprague Telecap\* Tubulars are superior to every other molded paper capacitor because they are made by the same dry assembly process as large metal-encased oil capacitors. They *cannot* be contaminated by dust or moisture during manufacture.

Every Sprague Telecap, from 600 to 12,500 volts, is molded *dry* . . . then mineral-oil impregnated under high vacuum through a small opening . . . and the terminal solder-sealed after the lead is inserted.

Result? Top resistance to heat and moisture . . . extra high insulation resistance . . . superior capacitance stability . . . and a capacitor that is preferred by the nation's leading television manufacturers.

Ask for Telecaps at your jobber's. Or write for bulletin covering details and specifications.

## TELECAP\* TUBULARS

Hollow eyelet terminal for oil impregnation after molding

Non-flammable, dense bakelite phenolic-molded housing

Uniform windings of high purity paper and aluminum foil

Solderseals as in large metal-encased oil capacitors

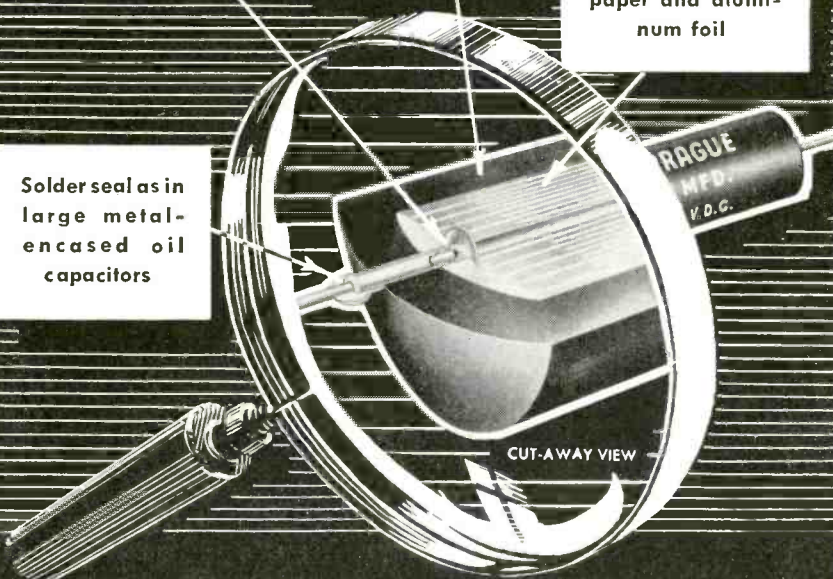

**SPRAGUE** SPRAGUE PRODUCTS COMPANY  
North Adams Mass.

PIONEERS

IN ELECTRIC AND ELECTRONIC DEVELOPMENT

★Trade Mark

required to effect a good balance. A highly directional microphone will help.

Most dance bands may be divided into three sections: rhythm, brass, and wood winds. In the rhythm section the average band will have piano, drums, and string bass; in the brass section, several trumpets and a trombone; in the wood-wind section, perhaps three saxes, some players doubling on clarinet. The usual arrangement finds the brass at the back of the stand, with wood winds in the front line. The rhythm section is often subject to wide variations in position, and usually presents the greatest pickup problem. One reason is that the instruments differ widely in the amount of sound each produces: piano, medium to loud volume; string bass, low volume; and drums, high volume.

As a start, the microphone may be placed in front of the band, probably toward the end where the piano is located, and facing more or less laterally across the front of the orchestra as in Fig. 2-a. The string bass may be required to move closer to the mike; but if the bass player is moved too far from the piano, you are looking for trouble, because he depends on the piano, which sets and sustains tempo for the entire band.

No hard or fast rules on the subject

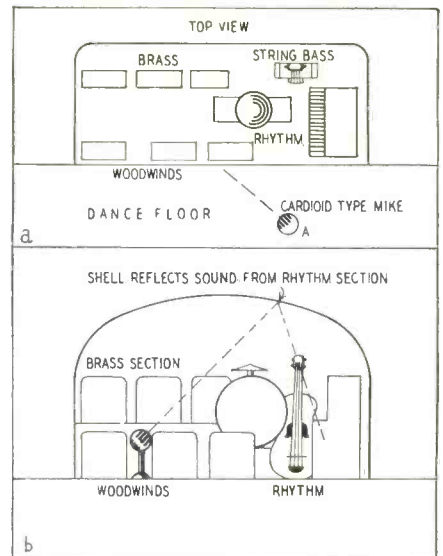

Fig. 2-a—Cardioid microphone facing orchestra at angle sometimes does best job. Fig. 2-b—Microphone in woodwind section picks up other instruments by reflection.

can be laid down; each band and each hall presents its own peculiar problems. But *do not* let the band leader dictate the microphone placement. One once gave us a very questioning look when we placed a cardioid mike right between two men in the front line and faced it to the ceiling as in Fig. 2-b. The pickup must have been satisfactory, because everybody in the band bought a copy of the completed record!

We are assuming a one-mike pickup in the foregoing discussions; we are not in favor of multimike pickups. They tend to destroy the illusion of perspective or depth, besides presenting  
(Continued on page 68)

**YOU BUILD 'EM  
IN ONE EVENING  
BUT...**

**THEY LAST A LIFETIME!**

**SAVE 50% WITH**

**LABORATORY  
PRECISION**



**INSTRUMENTS  
& KITS**

**SENSATIONAL NEW**

**EICO Model 360-K TV-FM SWEEP  
SIGNAL GENERATOR**

• Crystal marker oscillator with variable amplitude. • Covers all TV and FM alignment frequencies between 500 kc. and 228 mc. • Sweepwidth variable from 0-30 mc. with mechanical inductive sweep. • Extremely wide sweepwidth allows gain comparison of adjacent RF TV Channels. • Provides for injection of external signal generator marker. • Phasing control included. • Large, easy-to-read dial is directly calibrated in frequencies. • Versiter Tuning Condenser. • Comes complete with all tubes (including new, high-frequency miniature types): 6X5GT, 12AU7, two 6C4's. Crystal not included. 10"x8"x6 3/4". 5 Mc. Crystals available for above, each \$3.95.  
**FACTORY-WIRED AND TESTED Model 360. Ready to use Sweep Signal Generator. \$39.95**  
See it at your local jobber!

**\$29.95**

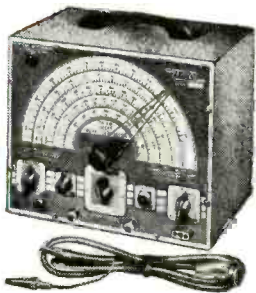

**ANYONE  
CAN BUILD  
THEM!**

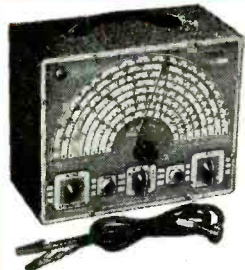

**NEW! MODEL 320-K  
SIGNAL GENERATOR**

For FM, AM alignment and to provide TV marker frequencies. Highly stable Hartley oscillator has range of 150 kc. to 102 mc. with fundamentals to 34 mc. Colpitts audio oscillator supplies pure 400 cycle sine wave voltage for modulation. Versiter Tuning Condenser. Use audio oscillator voltage to test distortion in audio equipment, bridge measurements, etc.  
**FACTORY-WIRED AND TESTED Model 320. Ready to use. . . . \$29.95**

**\$19.95**

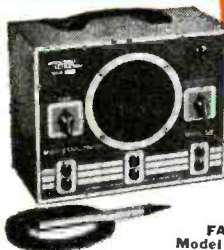

**VERSATILE MULTI-  
SIGNAL TRACER**

Model 145-K. High gain—high frequency. Self-contained test speaker permits audible signal tracing of RF, IF, FM, audio and video circuits. Provision for visual tracing with VTVM. Response is well over 200 mc. 3-color hammertone panel. 110-125 V. AC. Size: 10"x8"x4 3/4". Comes complete with tubes and diode probe in kit form.  
**FACTORY-WIRED AND TESTED Model 145. Ready to operate. . . . \$28.95**

**\$18.95**

**NEW PUSH-PULL 5"  
TV OSCILLOSCOPE  
Model 425-K Kit**

ALL-NEW laboratory precision scope has Push-Pull deflection and .05 to .1 volts per inch sensitivity. Wide-range, flat from 5 cps to 500 kc. with full gain setting, useful to 2 1/2 mc. Wide-range, multi-vibrator, sweep circuit from 15 cps to 75,000 cps. Direct connection to plates of CIT available at rear of cabinet. Z axis intensity modulation feature included. Size: 8 1/2"x17"x13" high. Complete with 3-6SN7s, 2-6J5s, 2-6Y3s, and 5DPI CRT.  
**FACTORY-BUILT OSCILLOSCOPE Model 425. Fully wired and tested \$69.95**

**\$39.95**

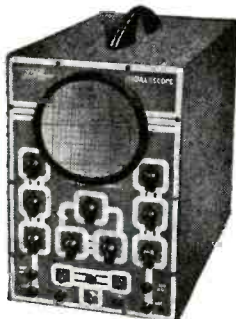

**HIGH PRECISION  
VACUUM TUBE  
VOLTMETER  
Model 221-K**

Tops in workbench versatility—15 different ranges! AC and DC ranges: 0/5/10/100/500/1000 volts. Electronic ohmmeter ranges from .2 ohms to 1000 megohms in 5 steps. New features include Zero Center for TV discriminator alignment, 26 Meg. DC input for impedance, Accurate, 4 1/2" meter cannot burn out. Double triode balanced bridge circuit assures guaranteed performance. Sturdy portable steel case with etched rubproof panel. Will measure up to 30,000 V. and 200 Mc. when used with our HVP-1 or P-75 probes. 110-130 V. AC 50-60 cycle. Size: 9 7/16"x6"x5".  
**FACTORY-WIRED AND TESTED Model 221. Same, but completely wired, calibrated, and tested. . . . \$49.95**

**\$23.95**



**DELUXE SIGNAL  
GENERATOR  
MODEL 315**

Completely wired, ready-to-use Signal Generator with 1% accuracy! A wonderful instrument with dozens of expensive features. Frequency range: 75 kc to 150 mc. Has microcycle hand-spread vernier tuning for FM, AM, and TV. Voltage regulator. Write for full details. **\$59.95**

Model 511-K. A "Must" for every serviceman! Small, handy instrument used a thousand times a day. Large 3" meter, beautifully etched panel. A perfect kit for beginners. Simple to assemble. Ranges: DC 0/5/30/250/500/2500 volts. AC 0/10/100/500/1000 volts. Output—0/10/100/500/1000 v. DC Ma.—0/1/10. Ohm meter 0/300/100,000 ohms/0/1 meg. DB meter —8 to +55 Db. **\$14.95**  
**ASSEMBLED—READY TO USE Model 511—Completely wired, tested, and assembled at the factory. Rugged, built for heavy duty. . . . \$17.95**

**VOLT-OHM  
MILLIAMMETER  
Complete Pocket Kit**



**\$14.95**

**WRITE FOR NEW CATALOG C**



**Model  
HVP-1**

**HIGH VOLTAGE PROBE**

Complete top-quality Voltage Test Probe Measures up to 30,000 Volts. Special Helical-Wound Ceramic HV Multiplier Resistor adaptable to most VTVM's and all 20,000 ohms per volt meters with 1000 or 5000 volt scales. Lucite head, plywood bakelite handle, large flashguards for additional safety. Specify your instrument. Complete, ready to use. **\$6.95**

**ASK YOUR LOCAL  
JOBBER**

About EICO's New Tube Tester Kit Model 625K —"the most versatile tube tester ever designed."

**Prices Higher  
on West Coast**

**HIGH FREQUENCY RF PROBE**

Model P-75K germanium crystal probe for visual RF signal tracing and measurements to over 200 megacycles. Can be used with models 221 or 113A Eico instrument (state which when ordering). 6 1/2" long. 1/2" O.D. with wire, plugs, and all components.  
**IN KIT FORM . . . . \$3.75**  
Model P76K same as above, but for oscilloscopes; in kit form. **\$3.75**  
Models P75 or P76 similar to above but factory wired, ready to operate. Each. **\$7.50**

**EASY-TO-FOLLOW SCHEMATIC & PICTORIAL DIAGRAMS**

Come complete with every EICO instrument kit. Each kit fully guaranteed to operate perfectly when assembled according to our simple instructions!  
**EXCLUSIVE LIFE-TIME REPAIR SERVICE:** For a nominal charge, we will repair and service your EICO instrument, regardless of its age!



**ELECTRONIC INSTRUMENT CO., INC.  
276 Newport Street, Brooklyn 12, N. Y.**

Makes TV  
work easy to  
understand!



## CASH IN ON TELEVISION SERVICE PROFITS!

### PRACTICAL TELEVISION SERVICING

By J. R. Johnson and J. H. Newitt  
375 pages, 6 x 9, over 230 illustrations  
Price only \$4.00

Here, in one handy volume is a complete guide to installing and servicing television receivers. PRACTICAL TELEVISION SERVICING tells you what to do—how to do it—how to set up shop—what mistakes to avoid—exactly how to proceed in practically every case of TV receiver maintenance. Includes dozens of actual shop case histories; explains troubleshooting, wiring, repair and component replacement techniques; gives complete antenna and installation data—in short covers the complete range of television servicing subjects.

#### COMPLETE—EASY TO UNDERSTAND

Not a book of mere theory and mathematics, PRACTICAL TELEVISION SERVICING shows you step by step how to do the work in a way you can easily understand. "An excellent text for both student and television serviceman for its methodical presentation of servicing techniques," says the *Journal of the Franklin Institute*. "The section on receiver installations alone is well worth the price of the book," writes *Radio Electronics*. You take no risk! Use coupon for 10-day money-back guarantee offer.



## MAKES AUTO RADIO REPAIRS twice as easy!

A profitable, good-paying  
service business

### SERVICING THE MODERN CAR RADIO

By A. L. Hurlbut

2nd edition, 702 pages, 8 1/2 x 11, 222 illus. and  
over 500 car radio diagrams, Price \$7.50

Here—prepared by an auto radio expert—is everything you need to know to install, service and repair auto radios faster, easier and more profitably. This big book covers every type of auto radio from the mid-1930's and gives you complete installation, troubleshooting and repair procedures plus tips on how to set up shop and get this profitable business.

#### OVER 500 CIRCUIT DIAGRAMS

Differences between car and home radios are clearly shown. Other subjects include antennas; antenna input circuits; power supplies; circuit features; automotive electrical systems and noise suppression; installations; loudspeakers; vibrator maintenance; alignment; push-button tuning and other related subjects. Of particular importance, *SERVICING THE MODERN CAR RADIO* contains over 500 circuit diagrams giving details of specific car radio types you are most commonly called upon to repair. Use coupon today for 10-day money-back examination.

### 10-DAY MONEY-BACK GUARANTEE

Dept. RE-50, MURRAY HILL BOOKS, Inc.  
232 Madison Ave., New York 16, N. Y.

Enclosed find \$..... for which send the following books; or  send C.O.D. (in U.S.A. only) for this amount plus postage and I will pay postman. In either event it is understood I may return books in 10 days if unsatisfactory and you guarantee to refund my purchase price.

PRACTICAL TELEVISION SERVICING.  
\$4.00 (\$4.50 outside U.S.A.)  
 SERVICING THE MODERN CAR RADIO.  
\$7.50 (\$8.00 outside U.S.A.)  
(Outside U.S.A. cash only—some return privilege)

Name .....

Street .....

City, Zone, State.....

a greater problem in maintaining balance and levels.

#### Making the record

Having obtained what to us is correct balance, we make a test cut on a separate disc. The test is long enough to make sure the recorder is properly adjusted: correct angle and depth of cut, thread throwing properly, etc. We use a sapphire cutting stylus: anyone cutting records professionally cannot afford to use anything less. Sapphires are less expensive in the long run and give lower surface noise and higher fidelity.

Selection of recording blanks is important. Of the numerous makes on the market now, many are excellent. On the other hand, some would be expensive if you got them free! A hard spot

We make a standard practice of cutting "flat" and playing back the same way. Then we play the record (or part of it) back again with tone compensation set to *bass* (really attenuating the treble), explaining that is the quality most record players deliver. Many people prefer it to the "harsh" reality of flat reproduction. We tone-control the *first* playback on a certain type of singer whose voice has a natural "harmonic distortion" in it. This distortion, coupled with even a slight amount of harmonic distortion in the recorder, is not pleasing—though quite realistic. In this case, a reduction in the treble response will make the client much more pleased with the results.

After the playback is the time to ask if your client wishes duplicates. Explain that duplicates are best made

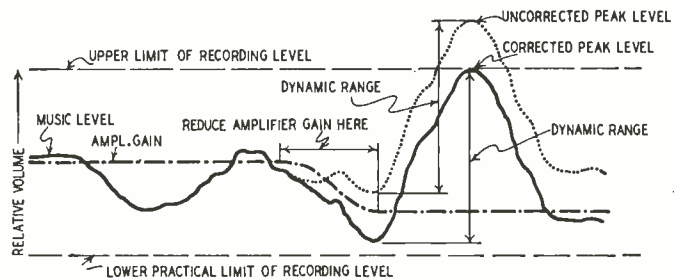

Fig. 3—Reducing amplifier gain before peaks instead of on them preserves the difference between maximum and minimum levels and the original dynamic range.

in the coating can ruin a sapphire stylus. Moreover, the type of coating determines whether the record will have a long or short playing life. Our own sad experiences with various brands makes us shy away from those which produce a "goopy" thread—the kind that rolls up into a soggy mass. The playing life of such discs is short; they lack brilliance, may produce "echo", and become noisy rapidly.

Having made the test cut, we play it back to our clients. If the balance suits them, we go ahead; if not, we change the microphone placement, and make a further test cut to check the new balance.

In the actual making of the record, control of volume is more important than is sometimes realized. Wide dynamic range (variation in loudness which contributes to musical expression) is desirable from a standpoint of realism, but must be sacrificed to some extent so quiet passages are not lost in needle scratch. A properly cut acetate recording is practically noiseless when new, but successive playings usually add more surface noise than to a commercial pressing. By compressing the dynamic range—increasing volume of soft passages and decreasing volume of loud passages—you can add many playings to the useable life of the record. But it requires considerable skill in handling the volume control. The main trick to be acquired is *anticipating* volume peaks, and reducing gain just *before* the peaks occur. This not only makes for unnoticeable volume changes, but also preserves the *illusion* of greater dynamic range. The method is illustrated in Fig. 3.

before the record has had many playings. Be prepared to cut the duplicates then and there, if at all possible. We have found duplicates will often turn a little job into a well paying one. Quality of the original record is, of course, the thing that sells "dubs." And if you have a top-quality playback unit, you can make duplicates that cannot be told from the original by the average listener.

The final step is an important one: neatly typing the title onto your *own* printed label, and sticking it on with rubber cement. It's your advertising—so don't use the standard label supplied on the record blank. Our own label appears on all our records.

When we had our labels made up, we purposely omitted any dotted lines such as "Title.....," "Date.....," etc., which gives the label a "filled-in" appearance. The top half is devoted to the printed name of the studio; the bottom half is left blank, for typing in the details—title of selection, artist, and so on. As we cut all personal recordings outside-in, no special instructions are necessary. (Outside-in cutting gives the record a more professional quality, as it duplicates standard pressings.)

Finally we provide with each record a mimeographed sheet of suggestions outlining proper care and handling. At one corner we affix a "shadowgraphed" playback needle. The instruction sheet proves valuable in forestalling trouble: if a record is damaged by a customer, he can't say he hasn't been warned!

If our repeat recording business is any criterion, striving for perfection pays off!

RADIO-ELECTRONICS for

**HUM REDUCTION**

Hum can be reduced at the output of R-C filters simply by connecting a resistor R between the rectifier cathode and the output of the filter, as shown in the diagrams. R should equal approximately 10 times the total resistance in the filter.

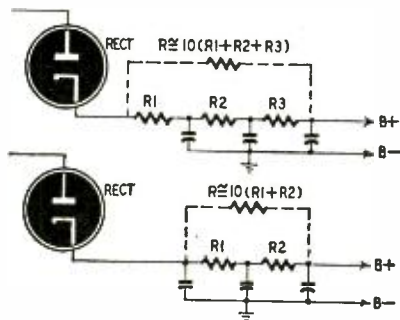

When R-C filters are used in B-supplies, the ripple voltage across the output capacitor is out of phase with the ripple voltage at the cathode of the rectifier. Resistor R delivers to the output capacitor ripple voltage which bucks out some of the ripple which passes through the filter. The combination of ripple voltages being less than the ripple voltage without R, the hum level is reduced.

A variable resistor may be used to find the best value for R. Adjust it to the point of least hum, measure it with an ohmmeter and replace with a fixed resistor.—Leon Medler

**\$1,200.00 PRIZE CONTEST  
RADIO-ELECTRONICS IN THE HOME**

Midnight of June 1, Eastern Standard Time marks the closing of the third month's Radio-Electronics in the Home contest. Entries for the June contest must be postmarked before this date. The closing date for the May contest is midnight, May 1.

- FIRST PRIZE . . . . . \$50**
- SECOND PRIZE . . . . . \$25**
- THIRD PRIZE . . . . . \$15**
- FOURTH PRIZE . . . . . \$10**

Monthly prizes totaling \$100 are given for the best ideas on applications of radio-electronics in the home.

Prizes will be awarded in accordance with novelty, general importance of the application or device, smallness of cost involved in building it, and practicability.

Any ideas may be submitted. Highest prizes will be awarded to contestants who have actually built the device and submit photographs to prove it. Lesser prizes will be given for "ideas" and entries not accompanied by photographs.

For complete details and rules of the contest see page 35 of RADIO-ELECTRONICS for March.

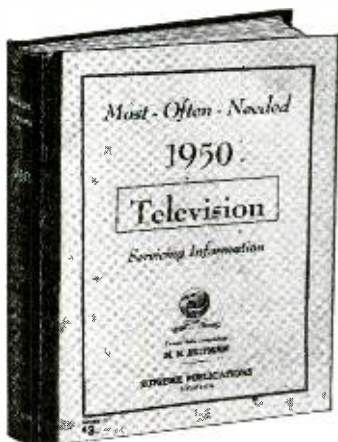

**New SUPREME 1950 T-V Manual**

**DATA ON ALL POPULAR TV SETS**

In this new giant volume of 1950 television factory data, you have everything you need to repair every present-day television set. You receive easy-to-understand explanations of circuits, 144 pages of alignment procedure, test patterns, response curves, waveforms, voltage charts, adjustment hints, and diagrams on mammoth 11 x 15-inch blueprints. This newly published 1950 TV manual is a virtual treatise on practical television repairs. By normal standards, such a large manual packed as it is with practical facts, hundreds of illustrations, diagrams, charts, photographs, and expensive extra-large blueprints, should sell for \$10—but as another SUPREME special value, it is priced to servicemen at only \$3, postpaid. Only a publisher who sold over one million TV and radio manuals can offer such bargain prices based on tremendous volume-sales.



**AMAZING BARGAIN IN TV MANUALS**

For 17 years, radio servicemen received remarkable values in SUPREME PUBLICATIONS service manuals. The television series is the most amazing bargain and defies competition. There is nothing else like it. The new 1950 TV manual is described at left. Above are illustrated the earlier volumes covering 1949, 1948, and 1947 TV and F.M. Use these on-the-job manuals to repair any television set. Yes, these manuals will tell you where to look and what to do. Stop guessing. Cut hour-wasting jobs to pleasant moments. Use any of these manuals without risk for 10 days. Just send coupon below.



Compiled by M. N. Beitman, radio engineer, teacher, author, and serviceman.

New 1950 TELEVISION manual contains complete service data on all popular present-day television sets of all makes. Gives description of modern circuits, test patterns, response curves, oscilloscope waveforms, alignment tables, service hints, diagrams in the form of double-spread blueprints, test points, voltage charts, etc. Large size: 8 1/2 x 11 in., manual style binding, flexible covers, at Your Jobber or by mail, only . . . . . \$3

**SUPREME RADIO DIAGRAM MANUALS**



1949 1948 1947 1946 1942 1941 1940 1939 1926-1938  
**SUPREME Most-Often-Needed RADIO DIAGRAMS**  
 Each Manual only \$2. (1949 is \$2.50); 192 pages of diagrams, alignment data, voltage values, parts lists, and service hints; large size, 8 1/2 x 11". To order, see coupon → Price, \$2.50

**Supreme Publications**

Sold by all Leading Radio Jobbers

**NO-RISK TRIAL ORDER COUPON**

**SUPREME PUBLICATIONS, 3727 W. 13 St., Chicago 23, Ill.**

Send television manuals checked below and radio diagram manuals at right. I am guaranteed satisfaction or my money back.

- New  1950 TV Manual, \$3.— 1949 TV, \$3.
- 1948 TV, \$3.— 1947 TV & F.M. only \$2.
- I am enclosing \$ . . . . . Send postpaid.
- Send C.O.D. I am enclosing \$ . . . . . deposit.

Name: \_\_\_\_\_  
 Address: \_\_\_\_\_

- Most-Often-Needed Radio Diagram Manuals**
- New 1949 Manual, \$2.50
  - 1948
  - 1947
  - 1946
  - 1942
  - 1941
  - 1940
  - 1939
  - 1926-1938 Manual, \$2.50
- PRICED AT ONLY \$2 EACH**

# SERVICE TECHNICIANS ACCLAIM SENSATIONAL IRC control development

## Concentrikit

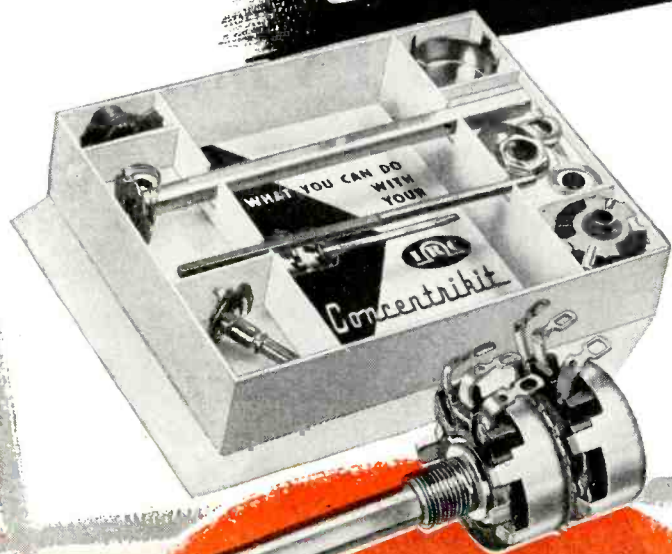

Amazing new IRC Concentrikit is the practical answer to your concentric dual replacement problems. With this set of specially designed parts you can assemble over 90% of all concentric dual types . . . no more long searches and waits for exact duplicates. You save time, worry *and* inventory investment.

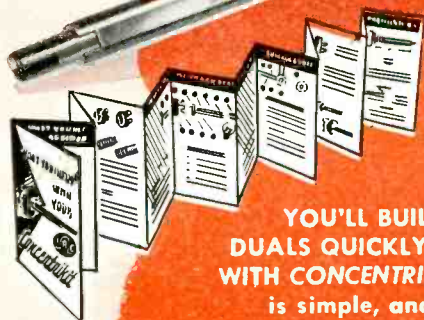

**YOU'LL BUILD CONCENTRIC DUALS QUICKLY AND EASILY WITH CONCENTRIKIT.** Assembly is simple, and can be completed in a few minutes. Step-by-step instructions are furnished with every kit.

**REPLACEMENT MANUAL AVAILABLE**  
Full replacement data on concentrics for all applications, from the earliest home and auto radios to television, are contained in a new IRC CONCENTRIC DUAL REPLACEMENT MANUAL. Be sure to get a copy from your IRC Distributor.





# STOCK ASSORTMENT

Television has greatly increased your concentric dual requirements . . . be ready with this CONCENTRIKIT Stock Assortment on your bench. Handsome metal cabinet contains all you need to assemble quickly any of 144 different concentric duals. It covers over 500 models . . . RCA, Admiral, Air King, Belmont, Emerson, General Electric, Motorola, Philco, Westinghouse, Zenith and many others. Order from your IRC Distributor now, or send coupon for more information. International Resistance Company, 401 N. Broad St., Philadelphia 8, Pa.

## HERE'S WHAT YOU GET

In Concentrikit Stock Assortment #13

	Quantity		Quantity
<b>Complete Concentrikits</b>	<b>4</b>	B19-133X	1
<b>Base Elements</b>		B11-137	3
B11-108	1	B13-137	2
B11-114	1	B13-137X	1
B11-115	1	B18-137XX	1
B11-116	1	B19-137X	1
B17-116	1	B11-139	2
B11-119	1	B13-139	1
B11-120	1	B13-139X	1
B11-121	1	<b>Inner Shaft Ends</b>	
B11-123	2	E-187	3
B11-128	2	E-190	1
B11-130	1	E-202	2
B13-130	2	<b>Sleeve Bushings</b>	
B13-130X	1	S-4	1
B18-130X	1	S-5	1
B18-132X	1	<b>Resilient Retainer Rings</b>	10
B11-133	2	<b>Switches</b>	
B13-133	2	76-1	3
B13-133X	1		
B18-133X	1		

Concentrikit Stock Assortment comes in a sturdy all-metal cabinet. Four drawers and individual compartments assure efficient stocking . . . and cabinets may be stacked with IRC Resist-O-Cabinets to make a convenient and good-looking shop arrangement. METAL CABINET IS SUPPLIED AT NO EXTRA CHARGE, you pay only the regular price of the parts.

and the price is—

**ONLY**  
**\$24.78**  
 dealer net cost

**ORDER YOURS TODAY!**



**INTERNATIONAL RESISTANCE COMPANY**

*Wherever the Circuit Says*

In Canada: International Resistance Co., Ltd., Toronto, Licensee

**INTERNATIONAL RESISTANCE COMPANY**  
 417 N. Broad Street, Phila. 8, Pa.

I'm interested. Send Catalogs DC1A and DC2S with details on CONCENTRIKIT and Dealer Stock Assortment.

Enclosed find 25c in stamps or coin for my copy of IRC Concentric Dual Replacement Manual.

Name.....

Company.....

Address.....



**NIAGARA IS INTERFERENCE ELIMINATION HEADQUARTERS! NIAGARA HIGH-PASS FILTER**

Guaranteed to eliminate R.F. Interference in any standard TV Receiver. Really works!

STOPS ALL AMATEUR, INDUSTRIAL, DIATHERMY, TVI. TRY IT

**BEEP BLOOP BLAP**

MONEY BACK IF IT FAILS!



Built-up—ready to install. Cat. No. C 281..... **\$2.95**  
 Kit Form (easy to assemble). Cat. No. C 281K..... **\$1.95**  
 Plus 15c packing and mailing in U.S.A.

**ATTENTION MOBILE FANS!**

Niagara introduces its mobile noise suppression package designed by W2QDM for guaranteed elimination of noises from Generator hash, spark plugs, distrib., wheels, etc. Money back if not delighted!  
 Noise Suppression Kit, Postpaid in U.S.A. Cat. No. 425K..... **\$3.00**

**MORE BARGAINS IN SURPLUS EQUIPMENT**

1-2 or 3 of each • Check every line!

(All items on hand May 1st subject to subsequent sale)

- Wilcox CW-3-110V Superhet Revr. New.....\$75.00
- Antenna Rotating Motor RL-42A Reel Exc..... 2.95
- W.E. XMTR MOD. Comp. w/controls spares..... 225.00
- MN 26C Radio Compass—New..... 32.00
- MN26C Radio Compass—Used..... 26.95
- 733D Localized Receiver Exc..... 6.95
- AN-APN-1 Altimeter—L.N..... 18.95
- 274N Modulator BC456A w/tubes Exc..... 2.65
- 274N Modulator BC456A Pair less tubes..... 1.65
- SCR 522 Receiver BC624 Exc. less tubes..... 7.95
- BC 1000A Transceiver New..... 300.00
- BC 645 Transceiver, Contr. Box, Dyn. In-struction book, New..... 17.95
- T-17 Hand-cite 200 Ohm Imp. Exc..... 3 for \$1.95
- PE 94 24V. DXN. for SCR522 Used L.N..... 3.95
- Surplus Radio Conv. Manual Vol. 1 or 2..... 2.50
- BC 654 80 Meter XMTR & RCVR. w/tubes XTAL L.N. 24.95
- ASD Parabolic Antenna—Rotable—L.N.
- BC221 Freq. Mtr. w/XTAL & Callb. Book L.N.....\$75.00
- LM Freq. Mtr. w/XTAL, Book, Mod. Exc..... 90.00
- TBY, Navy 6 & 10 Mtr. Bat. Transceiver..... 34.95
- RME69 RCVR. w/SPKR—V.V. GD..... 59.00
- BC-375 Tuning Units—cased..... 4.95
- BC-375 Tuning Units Used—cased..... 3.95
- GE 25 Watt Phone XMTR Model GP4A Pow. Sup. Exc..... 29.95
- ATD 50 Watt XMTR New..... 49.95
- 1Q Navy 6V. Port. Audio Ampl. w/VIB. Sup..... 9.95
- Gibson Girl Emergency XMTR. New..... 2.85
- BC 614 Speech Amplifier For BC610 L.N..... 55.00
- W1252 Electronic Wavemeter 22-80 Mcs. Exc..... 44.95
- BC Ant. Tuner for BC610 L.N..... 59.90
- BC 342 Navy Comm. RCVR. Exc..... 69.95
- McMurdo Silver RCVR. Mod. 801 G-80 Mtrs. w/tubes L.N..... 29.95
- Gen-Set 50-54 Mc. Conv. L.N..... 24.95
- Beach 80 Meter VFC New..... 19.95
- Handy 28.5-29.7 Mc. Conv. New..... 24.95
- BC-347C Interphone Amplif. L.N..... 2.95
- Dynamotor SA 5088 Imp. 18V./Out P. 450V. 4.95
- GP7 Tuning Units—New—cased range A-D..... 4.95
- GP7 Tuning Units—Used—cased range A-D..... 3.95
- GP7 Tuning Units—Used—no case range A-D..... 2.95
- BC 610 Plug-in tuning units TU47 to TU54..... 3.50
- Sound Powered Phones Head and Chest set—Type O—New..... \$ 4.95
- Sound Powered Phones Head and Swing-Away mike—Type Q—New..... 9.95
- Low Pass TVI Filter Kit..... 4.95
- RT Cut 1000 KC Crystal..... 4.95
- BC221 Sub-Assy—New..... 6.95
- Ferris 16C Sig. Gen. Re-callib..... 1000.00
- HS-33 Headphones—Brand New..... 2.95

**Niagara Radio Supply Corp.** Phone Dlgby 9, 1132-3-4  
 DDBL C50 160 Greenwich Street, New York 6, N.Y.



This 4-tube receiver has high performance. Note feedback loop around i.f. can.

# A High Performance Short-wave Midget

By HOMER L. DAVIDSON

THIS little 4-tube shortwave receiver has the performance of a six-tube superhet. The mixer and oscillator tube is a high-frequency 12AT7 duo-triode. Half of the triode is used as a mixer connecting through a mica trimmer capacitor to the antenna, and is cathode-biased. The other half is an oscillator

tube with a cathode-tapped oscillator coil. This tube is mounted on top of the chassis on its side (at the right end of the chassis, between panel and i.f. can, with its tip pointing outward) to make connections to the coil short.

The coils are wound with No. 28 enameled wire, as shown in the table, on 1-inch bakelite or fiber tubing 4

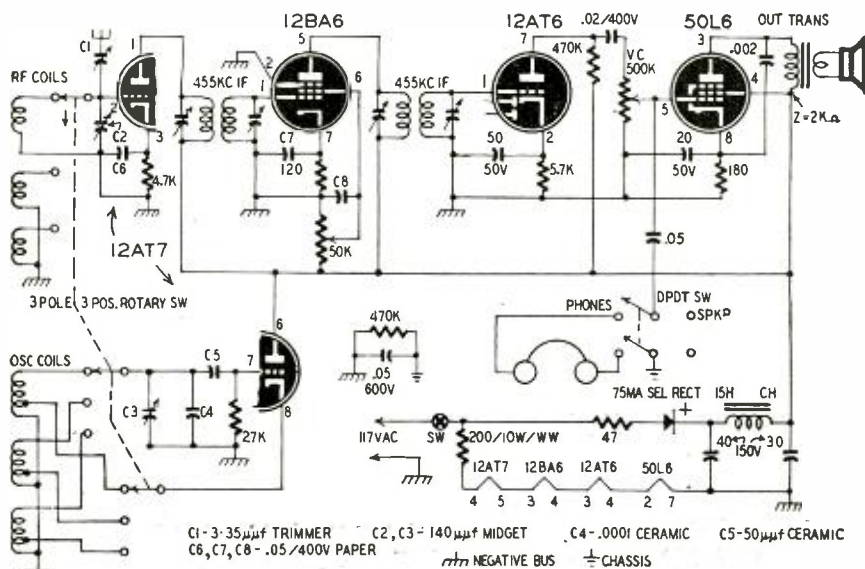

Schematic. Note that C2 and C3 are connected to negative bus, not to chassis.



# DETROLA TABLE MODEL RADIO

## KIT FORM:

BEAUTIFUL BROWN AND CREAM  
PLASTIC CABINET  
COMPLETE WITH 5 TUBES AND  
ALL PARTS, INCLUDING DIAGRAMS

# \$12<sup>95</sup>

A REG.  
\$29.95  
VALUE

### ALL-PURPOSE CHASSIS

Contains 3 plugs, 2 vol. controls, 1 25 wt. resistor 2600 ohms, 250,000 ohms 10 wt. resistors, 13,500 ohms, 10 wt. resistors, 3 1/2 mfd's, 3 bath-tub condensers 600V, 3 sockets, 4 shock mounts and many other parts in a blank top chassis.

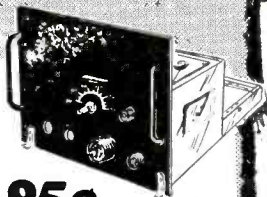

**95c**



**304TL \$1<sup>95</sup>**

Just the tube for that 1KW final — typical operation. 2500 volts at 400 MA. An ideal tube for that Induction heater or dielectric heater. Efficient operation at 1500V. to 3000V.

**T-17  
Carbon Mike**  
Like New **79c**



### COAXIAL FITTINGS



5c  
HOOD



25c  
SOCKET  
SO-239  
83-1R



35c  
PLUG  
PL-259  
83-1SP



20c  
ANGLE-  
ADAPTER  
M-355  
83-1AD

**\$2<sup>95</sup>**

Selsyn  
Indicator  
P/O  
Radio  
Compass  
5"  
New

### SELSYN MOTORS

TWO FOR **\$3<sup>95</sup>**



The ideal way of indicating the position of Rotary beams, wind indicator, etc. Line cord and instructions for 110 AC operation furnished on request.

### STANDARD BRAND CONDENSER

.1 MFD 7000 VOLTS



**\$1<sup>95</sup>**

### CD501A

Cord and plug set used with BC654 between PE 103 Dynamotor and Transmitter.

**\$1<sup>95</sup>**



### Butterfly Condensers

Oscillator assembly 76 to 300 MC with acorn tube socket mounted on condenser ..... \$3.95  
Type B Frequency range 300-1000 megacycles ..... 2.95  
BC4 Antenna condenser 105-330 MC... 3.95  
Oscillator 105-330 M.C. .... 3.95

### INDUSTRIAL PAPER OIL CAPACITORS

1. MFD  
5000 V. .... **\$2.95**  
1. MFD  
6000 V. .... **\$4.95**  
2. MFD  
6000 V. .... **\$8.95**

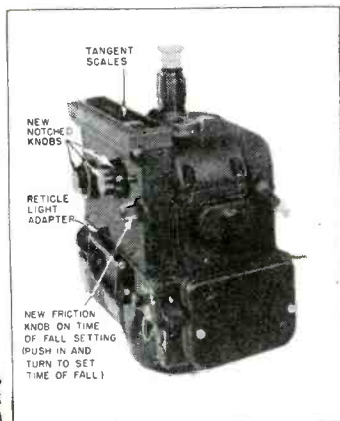
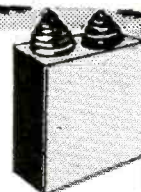

S-1  
Bombsight  
With  
M-2  
Modification  
Complete  
With  
Component  
Parts

**\$69<sup>95</sup>**

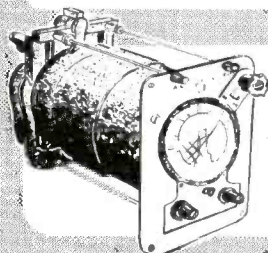

### BANK-CLIMB GYRO CONTROL

For Mark 4 automatic pilot

**\$4<sup>95</sup>**

### DIRECTIONAL GYRO M-1

A-5 Automatic pilot Mfd. by A. C. Spark Plug under license of Sperry Gyroscope Co., Inc.

**\$9<sup>95</sup>**

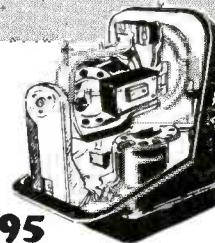

# HERSHEL RADIO CO

DEPT. RE. 4

Write for Free Catalogue

All orders F.O.B. Detroit—Minimum order \$2.00—Michigan customers add 3% sales tax—20% payment must accompany all orders.

5249 GRAND RIVER  
DETROIT 8, MICHIGAN

**NEW!** FOR FIELD OR BENCH WORK . . .  
**OAK RIDGE** **miniatures**  
 work like **GIANTS** for You!  
 EASIER, FASTER, MORE PROFITABLE  
 TV-FM SERVICING . . . at lowest cost!

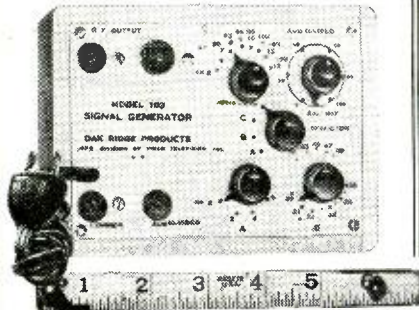

### OAK RIDGE 10-in-1 MINIATURE TV-FM SIGNAL GENERATOR

Pinpoints any signal failure from antenna to CRT or speaker in 2 minutes flat! Incorporates 3 separate tuning bands and modulation output and attenuator for TV & FM. Generates a signal to perform as complete . . .

• RF, OSC, and Mixer (1st Det.) Tester • Video IF Tester • Audio IF Tester • Video & Audio 2nd Detector Tester • Video & Audio Amplifier Tester • Sound Trap Aligner or Tester • Adjacent Picture Trap Aligner or Tester • Marker Generator • Antenna Orientation Tester • Antenna Sensitivity Tester.

You get **ALL TEN IN ONE** with this extremely adaptable, precision-made Model 103! Size: 5¼x4x2¼". Dealer's Net \$29.95.

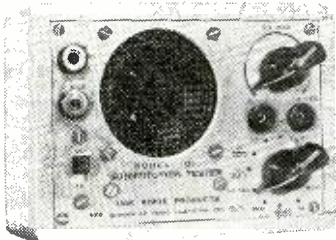

### OAK RIDGE 7-in-1 MINIATURE TV-FM-AM SUBSTITUTION TESTER

Which of these Servicing Aids do You Need Most?

• Test Speaker Without Transformer • Test Speaker With Transformer  
 • Paper Condenser Substitutor • Electrolytic Condenser Substitutor  
 • Fixed Resistor Substitutor • Variable Potentiometer Substitutor  
 • Audio Signal Tracer for Video, Audio & Sweep Circuits in TV, FM, AM, Audio Amplifiers, etc.

You get **ALL SEVEN IN ONE** with the versatile, precision-made Model 101! Size: 5¼ x 4 x 2¼" Dealer's Net \$16.25.



### OAK RIDGE 3-in-1 MINIATURE TV HIGH VOLTAGE TESTER

Accurately checks all high voltages in any direct-view or projection TV set. Has precision 10,000 ohm/volt movement, three scales: 0-500V, 0-15KV, 0-30KV. Complete with special high voltage test lead. Size: 5¼ x 4 x 2¼". Dealer's Net \$14.95.

Boost your efficiency and earnings! Ask your parts jobber for these amazing new MINIATURES today! Write for free Catalog T-E.

**OAK RIDGE PRODUCTS**  
 239 EAST 127th STREET NEW YORK 35, N. Y.  
 Manufacturing Division of VIDEO TELEVISION, INC.  
 Makers of the famous OAK RIDGE Patented  
 SNAP-LOCK TV-FM Antennas and Accessories.

## A HIGH PERFORMANCE SHORT WAVE MIDGET

(Continued from page 72)

inches long. The three oscillator coils are wound on one tube, and the r.f. coils are wound on the other. These tapped coils are soldered directly to the three-pole, three-position switch before mounting. The coils are wound to ½-inch, except the 80-meter r.f. coil which extends to 1 inch.

To get the coils to cover the bands completely, it may be necessary to add a few turns or to spread or close the turns of wire on the oscillator coils. These coils are vertically mounted between the horizontal 12AT7 and first i.f. can.

The 455-kc intermediate-frequency stage uses a 12BA6 amplifier tube with cathode bias. In this circuit, feedback is used to increase sensitivity. Surprising results are obtained by connecting a wire to the grid of the 12BA6 and wrapping it around the first i.f. can. There are many ways of getting feedback, but this method seemed to fit this receiver best. On 20 meters, the gain is most notable—twice that of the signal without feedback. Only two turns of insulated wire are needed around the first i.f. can to increase the gain tremendously. The 20-meter hams burst through from Maine, California, and the Florida coast at loud speaker volume.

An r.f. gain control is placed in the screen circuit of the 12BA6 i.f. stage. This control is a 100,000-ohm carbon potentiometer to vary the screen voltage on the 12BA6. The gain control works best in this receiver at about three-quarters maximum setting.

The second detector is a cathode-biased 12AT6 miniature audio tube. This tube seems to function best with a 5,700-ohm cathode resistor and a

50-μf, 50-volt electrolytic capacitor in the cathode circuit. Higher values may be tried. The two i.f.'s are identical input type 455 kc i.f. transformers.

A 500,000-ohm volume control varies the audio signal to the 50L6-GT power amplifier tube. It also can be switched to a pair of headphones as well. A d.p.d.t. switch is mounted on the front panel for this purpose. Believe it or not, but the volume must be lowered on all three bands when using the PM speaker. The volume control is almost in the off position when using headphones.

Coil Data Table

Band	80	40	20
Ant. coil (turns)	27	15	6
Osc. coil (turns)	11	7	4
Cathode tap (turns)	5	3	2

All coils wound on 1-inch tubing.

A 75-ma selenium rectifier is employed, with a standard filter system. With speaker operation, the 60-cycle a.c. hum is nil and on headphone operation can be heard only on the 20-meter band.

All the miniature tubes are wired in an a.c.-d.c. circuit and are in series. The 50L6-GT filament is at ground potential. It has been noted that the 12AT7 lights up brightly at first, but no ill effects have resulted as yet.

The chassis layout is shown in the photographs. Both chassis and panel are aluminum. The front panel was painted with two coats of crackle-finish paint, gray and green. You will notice

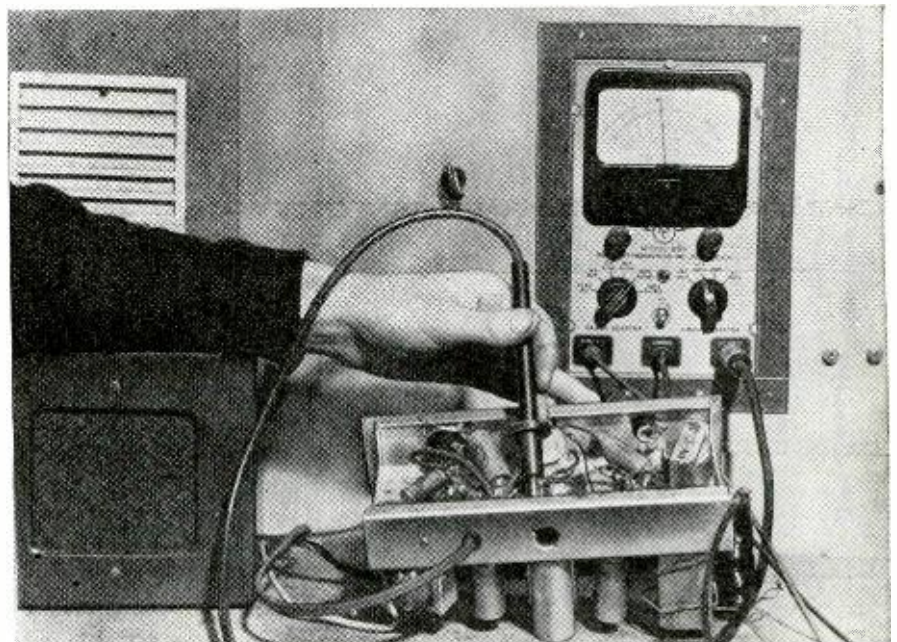

The set has adequate power to drive the 5-inch speaker shown on the left.

RADIO-ELECTRONICS for



**RC-213 ANTENNA EQUIPMENT**

This antenna was made to operate in the spectrum of 100-156 Mc. by use of three sets of dipoles furnished (4 dipoles per set). The antenna is continuously rotatable with 18' mast, mounted on ball bearing cones. Has bearing indicator, sense antenna, tuning unit for matching, handwheel for rotating, and coaxial connector to connect to your RG-8/U transmission line. All rustproof brass and aluminum components except cones and bearings. This unit originally packed in 6 boxes. Shipping wgt. approx. 600 lbs. Close out price—\$89.50

**BC-406 RECEIVER**, New, with tubes... \$17.50 ea.

**25c TUBES** 25c  
The following tubes are an overstock and are being sold at the ridiculous price of 25¢ to move. All are new JAN tubes, fully guaranteed. 1629, 1625, 12A6, 9003, 955, VT67—Ceramic base type 30.—Choice 25¢

**CR TUBES. NEW, GUARANTEED**

- 5CP1 ..... \$3.50
- 5FP7 ..... 2.50
- 3BP1 ..... 3.25

**STANDARD MAKE MODEL H 25 watt RHEOSTAT**, 150 ohm ..... 35¢ each

**\$1.75 MARKER BEACON RECEIVERS \$1.75**

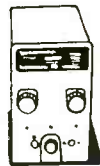

We have a pile of these to move and need space. They were used on aircraft from the 24 V. power supply to provide indication of cone, fan and approach markers on 75 Mc. modulated at 3000, 1300, 400 cycles. Reception of any of these modulated frequencies to operate 1 of 3 signal lamps connected to the output of the receiver. I have seen many interesting things done with these such as opening and closing garage doors from the car, controlled models, etc. These units sold as removed surplus aircraft. Size overall 3 1/2" x 5 1/2" x 5 1/2". Price..... \$1.75

★ ★ ★ ★  
**BC-1033** Same as above but more sensitive type. Has 1 more tube..... \$2.75 ea.

**HI-VOLTAGE INDUSTRIAL CONDENSERS**



.25 mfd. 20,000 V.. Manufactured by G. E. Pyranol, Standard Make, Cornell-Dubilier or Solar. Size on Cornell-Dubilier 8" wide x 4" thick x 17" overall height, 6" insulator. Others vary slightly. These condensers ideal for PF correction on HV transmission lines or in industry. All brand new and guaranteed first quality. At a fraction of original cost..... \$7.45 ea.

**\$1.75 TU-10-B TUNING UNIT \$1.75**

Brand new in metal case. Here is a value you cannot afford to pass. Stan said to move them, we need the warehouse space. It contains three 1/2" variable condensers as follows: 1—27 plate 20—120 mmfd., 1—16 plate 15—60 mmfd. and 1—7 plate 7—30 mmfd.; 3—2500 Volt. 0004 mfd. micas; 3—RF chokes; 1—9 turn inductance and 1—7 turn inductance on 2" ceramic form spaced 5 turns per inch. Vernier tuners, knobs, chart frame, etc. Can you pass it at..... \$1.75 ea.

**TYPE A-15 OXYGEN MASK**

New in original box. Use in aircraft, paint spraying or give the kids. 70¢ ea.  
D-2 Oxygen bottle with regulator for attachment to above mask. Used, but like new. Shipped less oxygen due to I.C.C. regulations. The complete outfit ideal for aviators, or to set you back on your feet after a hard night out. Price, D-2 bottle \$4.50 Complete bottle & Mask—\$5.00

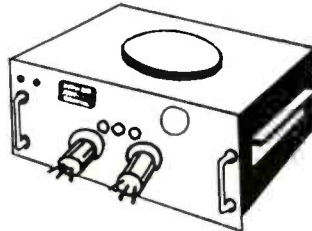

**BC-1158-A MODULATOR & TRANSMITTER**

Boys, here's one of the nicest pieces of equipment I have ever seen. In fact, we have not had to advertise them before due to the amount of store sales we have had; however, we are trying to move old merchandise for a lot of new coming in. This unit the hams find easy to convert for a super mobile 10-meter rig. It is crystal controlled, uses 4-815's, 10-125N's, all included, has motor fan for cooling, and tuning meter for alignment. If you don't know the unit, don't inquire as the small quantity I have will be exhausted before I could answer. \$19.50

**12 VOLT AIRCRAFT BATTERY—NEW—**



**\$8.95**  
Here is the ideal power source for your surplus equipment. These batteries are new dry-charged—add 1.260 SPG acid and they are ready to go. Rated 12 V. 34 A.H. In metal case with cover to protect other equipment from corrosion. Size, 10 1/4" wide x 10" high x 5 1/2" deep. Price, New..... \$8.95

**METERS—BRAND NEW 3" ROUND—\$1.00 each**

- Hoyt Model 531/L 0-600 DC ammeter. Used, external shunt not furnished..... \$1.00
- Hoyt Model 531/L 0-30 amp Ammeter. Internal shunt..... 2.00
- Hoyt Model 531/L 0-40 V. Voltmeter..... 2.00
- Westinghouse-type NT-35 RF Ammeter, 0-5 amps..... 3.50

**723/AB CAVITY OSCILLATOR TUBE OR REFLEX VELOCITY MODULATED TUBE**

Used in the local oscillator of radar sets. Operates at 9400 Mc. Shepard-Pierce W.E. mechanical tuning type..... \$12.50

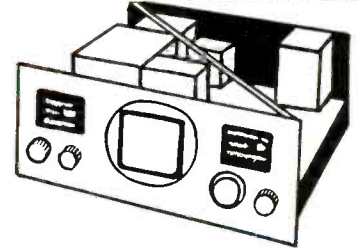

**CONTROL UNIT BC-1268-A**

Ideal foundation for building yourself a CR scope or TV set. Contains the 5CPI CR tube with socket and shield. 3—2.5, 2.5, 5 mfd. 600 WV condensers and 1—.2 mfd. 5000 V. condenser, 24 tube sockets. Numerous pots, including 7 1/2" precision, and variable condenser and gear mechanism, etc. These units new with tubes except CR tube removed. \$12.50 ea.



**RADIO SET SCR-619**

The radio set SCR-619 is a low power, 18 tube, crystal controlled, FM voice set consisting of a single unit receiver-transmitter BC-1335, Battery Charger, PE-219, and additional components. The set is designed for portable field operations from a 6, 12 or 24 V. source or self-contained storage battery. Operated in the range of 27 to 38.9 Mc. The average distance range is 5 miles but is greater under favorable conditions. Power output of transmitter 1 1/2 watts. The unit comes complete, brand new, in original packing with above units and batteries, ready to operate less crystals and antenna. We can supply some crystals for \$1.00 additional per crystal. These units have been finding favorable use with forestry, police and industrial. For portable or pack, use with other existing 30-40 Mc. FM equipment. Weight of BC-1335, 23 lbs. Size of BC-1335, 6-21/32" high x 12 1/4" wide x 13-9/32" deep. Our price, New—\$89.50

**RADIO SET SCR-511**

This set is a low powered, portable, AM Radio telephone, transmitter and receiver. Powered by dry or storage batteries. Operates in the frequency range of 2-6 Mc. Operating range is about 5 miles or more under favorable conditions. The set comes complete with new BC-745 transmitter and receiver and new T-39 chest unit only. Add batteries and tuning unit and you are ready to operate. We can supply only a limited amount of BC-746 tuning units in channels 3(3995 Kc.), 4(4845 Kc.), 5(5500 Kc.), 13(5305 Kc.) only, at a \$3.50 each additional price. Weight of BC-745 and T-39 approximately 13 lbs. Price New \$17.50 ea.

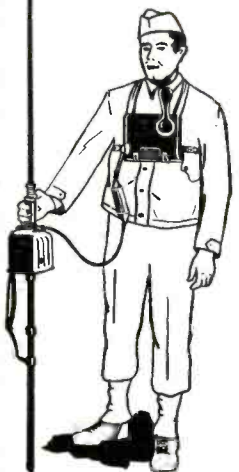

Power supply unit PE-157 for storage battery and loudspeaker operation of the BC-745. These units have self-contained 8B54 battery and charging unit. The unit is new; however, speaker is removed and sold as is. Price, complete with battery \$6.96

**AUCTION SALE!**

**THE TIME:** Saturday, May 13, 1950, starting at 10 AM 'til everything is sold if it takes until midnight.

**WHERE:** Esse Radio Company, 42 West South Street, Indianapolis, Indiana. Esse Radio Company will sell, at public auction, new and used surplus and currently manufactured radio electronic gear at your prices. This is a gigantic undertaking. Thousands and thousands of dollars' worth of merchandise will be sold. We invite you to come to this sale and promise it will be of tremendous interest.

**Marlin P. Maddux**, well-known auctioneer, will be in charge of this sale. Terms of the sale are cash. Come early to register. We are going to sell some or all of every item in our store during this sale. We especially want other dealers, who are interested in buying quantity, to attend this sale as well as individuals buying for their own use.

Although this sale, to be held May 13, 1950, will perhaps be the largest auction sale that Esse will hold, Esse will continue to have auction sales the 2nd Saturday of each month; so, if you can't come to our first sale, attend others.

Consign your surplus gear to Esse Radio Company for this sale. Esse will sell your equipment for a 15% commission. If you have anything that is connected with radio such as transmitters, receivers, tubes, test equipment, power supplies, condensers, speakers, amplifiers, modulators, dynamotors, etc., regardless of make, send it, or them, to Esse, transportation charges prepaid, and Esse will sell your merchandise for you on this sale. Your equipment should bring highest prices. Individuals, factories, radio clubs, other dealers, just anybody, send your equipment in to Esse for this tremendous sale. You will be placing your gear in the hands of experts for this sale but with the understanding that the consignment of material is final and without recourse as to the prices that it will bring. Everything sold on the sale goes to the highest bidder regardless of what the bid amounts to; however, we believe that the return that you receive for your gear will be fair. Help make this sale a bigger success. Send in your gear and what-not to Esse. (all transportation charges must be prepaid). Within five days after the sale, Esse will send you a check for whatever your gear brings, except for a 15% commission that Esse will charge you for handling. Act today! You must hurry to get your equipment to Esse in time for the sale (you don't need to correspond or contact Esse. Just send the gear in.) If you cannot get your equipment to Esse for this first sale, send it in anyway for the auction sale June 10, 1950. Remember, Esse will hold an auction sale the 2nd Saturday in every month and will accept consignment of merchandise for any sale.

ESSE RADIO COMPANY, 42 West South Street, Indianapolis, Indiana

**ESSE RADIO CO., 40 W. SOUTH ST., INDIANAPOLIS, INDIANA**

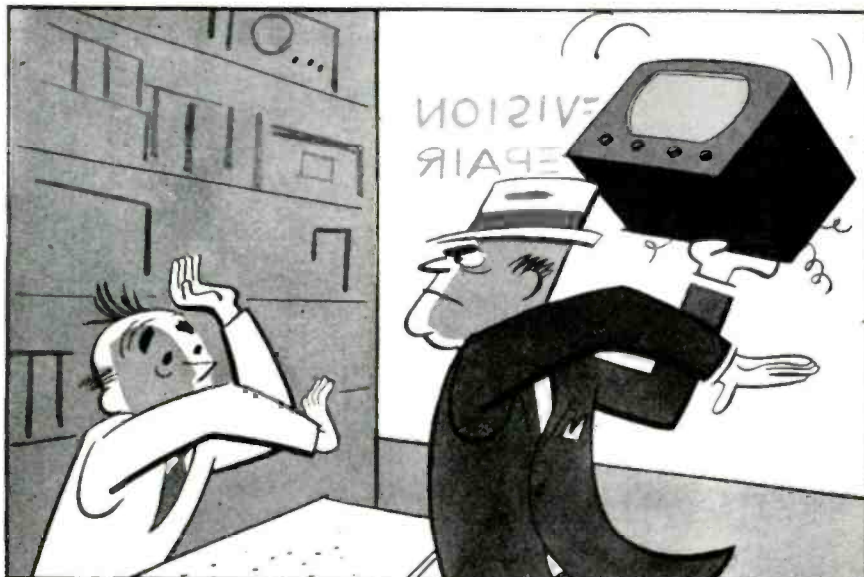

## Quality Parts...





for jobs that **WON'T BOUNCE BACK!**

A TV customer can get mighty angry when your repair job doesn't hold up. The trouble might be a defective part—not your fault at all—but you can't explain that to *him*. He pays good money to have his set put into shape.

As far as he is concerned, if it breaks down again *you* are to blame.

A satisfied customer is your most valuable business asset. Don't take a chance on losing it by using second-grade, "just-as-good" replacement parts. Use OHMITE parts—known the world over as the standard for dependability—and be sure! Take a tip from thousands of radio servicemen and electronic engineers, who have found through experience that OHMITE can be depended upon for years of trouble-free service.



 <p><b>Little Devil COMPOSITION RESISTORS</b></p> <p>Tiny, rugged. Resistance and wattage clearly marked on every one. 1/2, 1, and 2-watt—all RMA values. Tolerance <math>\pm 5</math> and <math>\pm 10\%</math>.</p>	 <p><b>BROWN DEVIL WIRE-WOUND RESISTORS</b></p> <p>Vitreous-enameled. Provide utmost dependability in small size. Mount by 1 1/2" tinned wire leads. Three sizes: 5, 10, and 20-watts. Tolerance <math>\pm 10\%</math>.</p>
 <p><b>DIVIDOHM ADJUSTABLE RESISTORS</b></p> <p>Vitreous-enameled, wire-wound. Odd resistance values quickly obtained. Ideal for voltage dividers. Stock wattages: 10, 25, 50, 75, 100, 160, and 200—many resistance values.</p>	 <p><b>TYPE AB POTENTIOMETER</b></p> <p>It's quiet! Has a resistance unit that's solid-molded. As a result, noise level often becomes less with use. Has a 2-watt rating, good safety factor.</p>

**OHMITE MANUFACTURING CO.**

4894 Flournoy St., Chicago 44, Illinois



Be Right with

WRITE FOR CATALOG 21  
Lists rheostats, resistors,  
chokes, etc.



# OHMITE

RHEOSTATS • RESISTORS • TAP SWITCHES

that the front panel is 1/2-inch longer than the subchassis so the flange will cover the metal mounting cabinet. The 5-inch pin-cushion speaker is mounted separately. Also note in the rear-view photo that the band switch protrudes through the top panel of the metal cabinet. A large slow-motion dial is placed on the oscillator tuning capacitor shaft and small knobs are used on other controls. The phone jack is mounted at the bottom right-hand corner.

In wiring the receiver, all wires should be short as possible. At first, the chassis was used as common ground but results were not too good. It is better to use a common bus bar or wire running from socket to socket. This reduces distributed capacitance as well as hum in the audio sections. Be sure to twist all wires around the prongs tightly and solder them securely with rosin-core solder.

After all parts are mounted and wired, the first thing to do is to peak the i.f. cans. If you have a signal generator, set it to 455 k.c. and use a .05- $\mu$ f paper condenser to couple the signal to grid prong No. 2 of the 12AT7. Remove the r.f. coil and insert a 100,000-ohm resistor in its place and then align both i.f. units. These coils are set at the factory so very little alignment is usually required. Be sure to go over both i.f. units, peaking them several times so that the first adjustment does not throw the next one off. The r.f. coil is then soldered back into place.

Turn the r.f. gain control full on and do the same with the volume control. In first testing the receiver, it is best to use the 80-meter coil. All the bands should be checked with various stations for correct frequency.

The oscillator tuning capacitor is tuned to a station and the r.f. tuning capacitor C2 is varied until the signal rolls in. On weak signals, C1 is very useful in tuning. C1 should be set so that the r.f. tuning capacitor C2 has a definite effect on signal strength. If C1 is set too tight, C2 has little influence on the tuning of the r.f. circuit. A happy medium should be sought for all three bands. In hunting for stations, tune slowly with the oscillator capacitor C3, and follow with C2. Background noise will tell you when the two circuits are tracking.

In a small set like this with no r.f. stage, it is no trouble to tune the oscillator and mixer capacitors separately, and eliminating the ganged capacitor also eliminates the tracking problem on the three bands.

#### Materials for Receiver

**Resistors:** 1—120, 1—180, 1—4,700, 1—5,700, 1—27,000, 2—470,000 ohms, 1/2 watt; 1—200 ohm, 10 watts, wire-wound; 1—50,000 ohms, 1—500,000 ohms, potentiometers.

**Capacitors:** 1—50, 1—100  $\mu$ f ceramic; 1—.02  $\mu$ f, 2—.05  $\mu$ f, 400 volts, paper; 1—50  $\mu$ f, 50 volts, electrolytic; 1—40, 30, 20,  $\mu$ f, 150, 150, 50 volts, electrolytic, can type; 1—3 to 35  $\mu$ f trimmer; 2—140  $\mu$ f midgeet variable.

**Switches:** 1—3-pole 3-position, rotary; 1—s.p.s.t. on volume control; 1—d.p.d.t. slide contact.

**Transformers:** 2—455 k.c. i.f.; 1—output, 2,000 ohm primary, multitap secondary.

**Miscellaneous:** 1—selenium rectifier, 75 ma; 1—15-henry 75-ma choke; chassis, sockets, speaker, headphones, non-shorting phone jack, hookup wire.

RADIO-ELECTRONICS for

### A TUNED TONE CONTROL

The tone controls on most radio receivers are insufficient; they merely permit suppression of the high notes, thus relatively favoring the bass. More effective "compensation circuits" become very complex, sometimes comprising adjustable resistors, capacitors, and inductors all in the same circuit.

Here is a variant that is very simple, yet gives excellent results. It is composed of two fixed-tuned, parallel-resonant circuits, with a variable resistor of 500,000 ohms shunted across each. (See Fig. 1.)

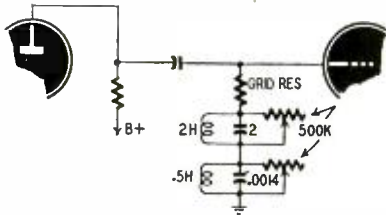

Fig. 1—Tuned circuits provide boost.

The control is placed in series with the grid resistor of the output tube. (If the circuit is push-pull, it may be placed in the grid circuit of the driver or phase-inverter.) The two circuits are tuned to the high and low frequencies at which re-inforcement is required, and their action regulated with the two variable resistors. (With the constants given, the high boost is around 6 kilocycles; the bass boost near 80 cycles.)

With these constants, the resistance in the grid circuit of the output tube appears to rise considerably near 80 and 6,000 cycles, and the signal applied to its grid increases accordingly. Thus these frequencies are amplified more, as indicated in Fig. 2. The frequencies

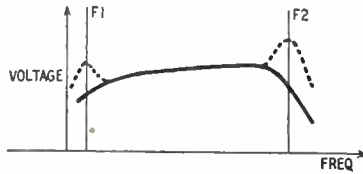

Fig. 2—Dotted curves show boosting.

f1 and f2 can be adjusted to compensate for the deficiencies of any given amplifier by choosing values of inductance and capacitance that resonate in the regions where reinforcement is needed.

The action is, of course, greater as the variable resistors are adjusted to increase the resistance across the tuned circuits, and can be cancelled altogether by reducing the shunting resistance to zero and thus shorting them. The output tube's grid resistor should be kept relatively low—100,000 ohms will probably be found suitable in most cases. If a much smaller value of grid resistance is used, the tone control adjustments may have an undesirable effect on the overall volume of the amplifier.—P. Hemardinquer

Want Better TV Reception?  
USE A Miller ANTENNA COUPLING TRANSFORMER

#### Clearer, Brighter Pictures

when these transformers match antenna impedance to line, or line to TV receiver. Signal input may be improved as much as four times! Designed to couple low-impedance antenna to standard 300-ohm line; or 300-ohm antenna to 72-ohm twin-lead or low-loss 52-ohm coaxial cable. At receiver, low-impedance line matched to standard 300-ohm input. Housed in impregnated, weather-tight aluminum shield.

Dimension: 3/4" by 3/4" by 1-3/8"

Cat. No.	Impedance Ratio	List Price
6161	52/300 or 300/52	\$2.50
6162	72/300 or 300/72	2.50



See your Wholesaler or write us for literature

**J. W. MILLER COMPANY**  
5917 S. Main St., Los Angeles, Calif.

\*BUILDERS OF QUALITY RADIO INDUCTANCES SINCE 1924

# BIG MONEY IN RADIO and TELEVISION NOW!

## See COYNE'S Brand New 7 Volume Set APPLIED PRACTICAL RADIO-TELEVISION FREE!



A BRAND NEW Set of books written for men who want to "go places" in TELEVISION and RADIO . . . men who know how a PRACTICAL working knowledge helps to get the BIG MONEY. Over 2500 pages of the latest Radio and Television "know how"; easy to understand with hundreds of crystal-clear illustrations. It's ALL here! EVEN COLOR TELEVISION AND UHF. How to install, service, align, balance ALL radio and TV sets . . . how to use new and old testing instruments for TV service . . . latest data on adapters, converters and MORE. Complete volume on Electronics and handy Radiomen's Handbook included. You name it and COYNE'S GOT IT, in this amazing new money-making 7-Volume Radio-Television Library.

**PRACTICAL!  
CLEAR!  
COMPLETE!**

7 fact-packed volumes — 1400 illustrations and diagrams with step-by-step photographs which "break down" the equipment to show what makes it "tick." Up-to-the-minute, complete, easy to follow.

**Color Television Is Here!**  
Set contains most complete section ever published on Color Television and UHF, adapters and converters. FULLY ILLUSTRATED AND PRINTED IN 4 COLORS.

#### Act Now and Get FREE Book

Now you can see these new Coyne books for 7 days without cost and get Coyne's book of 150 Radio and Television Diagrams FREE. It's free just for examining the new 7-Volume Set. Full details of this sensational Coyne "prove it" offer are given below. Mail the coupon at once.

### SEND COUPON—SEE SET FREE FOR 7 DAYS

You must SEE these new books to know how easy it is to prepare for the big jobs in radio and television. Here's our special offer: — we'll send the complete 7-volume set for your 7-Day FREE Examination. And with it, we'll include our valuable, new guide for all radiomen, "150 New Radio-Television Diagrams Explained," absolutely FREE! If you keep the 7-volume Set all you pay is \$3.00 within 7 days after the books arrive and \$3.00 per month until \$23.50 is paid — or you can pay \$22.00 cash price. If you don't want the set, return it and you OWE NOTHING. But either way you keep "The Radio and Television Diagrams Book" as a gift. That book is ABSOLUTELY FREE.

**SEND NO MONEY** Coupon is just a request to see Set free and get FREE BOOK. Offer limited—act now.

**COYNE Electrical and Radio-Television School**  
500 S. Paulina St., Dept. 50-F, Chicago 12, Ill.

### Mail This Coupon NOW

Educational Book Publishing Division  
**COYNE ELECTRICAL & RADIO-TELEVISION SCHOOL**  
500 S. Paulina St., Dept. 50-F, Chicago 12, Ill.

O.K. Send me postpaid, your new 7-volume set, "Applied Practical Radio-Television", on 7 days Free Trial per your offer. Be sure to include as a gift the book of 150 Radio-Television Diagrams absolutely FREE.

NAME \_\_\_\_\_ Age \_\_\_\_\_  
ADDRESS \_\_\_\_\_  
TOWN \_\_\_\_\_ ZONE \_\_\_\_\_ STATE \_\_\_\_\_  
Where employed \_\_\_\_\_

For the ultimate in T-V reception!

the sensational new

## GONSET "RADARRAY"

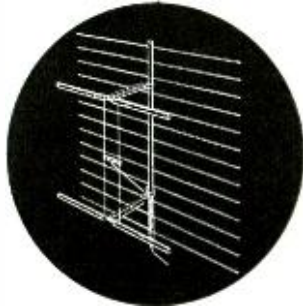

BASIC UNIT (4 DIPOLES)

- Very high gain on all channels. (Gain of basic unit equals rhombic 3 wavelengths per leg.)
- No significant rear pickup (virtually "dead" on all channels).
- Unexcelled ghost rejection on all channels (equals or exceeds rhombic).
- High channel model ideal for use with rotator.
- Basic units may be stacked for still greater gain.

This phenomenal antenna rapidly is becoming known as a "fringe area eliminator". Specify model L for channels 2-6; model H for channels 7-13. Engineering data available upon request.

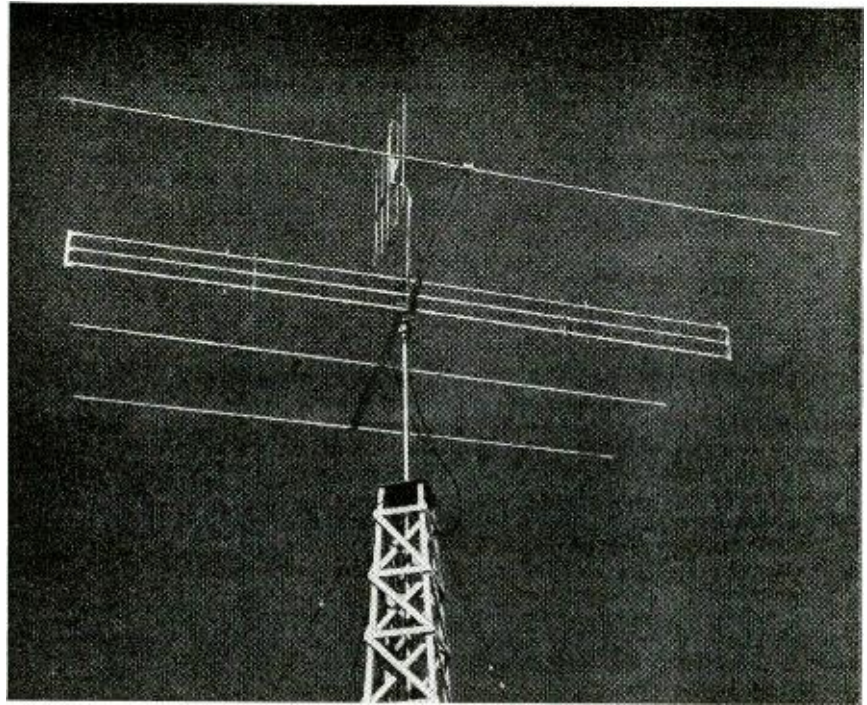

A view of the completed beam. Note the three conductors in the driven element.

# A Beam Antenna to Match 52-Ohm Coax

By LOUIS H. HIPPE, W6APQ

The ORIGINAL and Still the BEST  
**LIGHTNING ARRESTER**

for all  
weather  
conditions

will not  
absorb  
moisture

completely  
waterproof

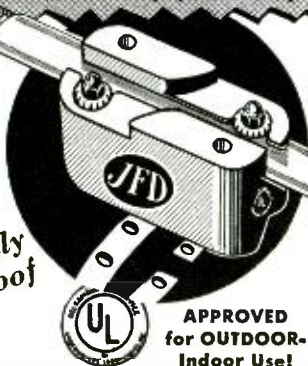

APPROVED  
for OUTDOOR-  
Indoor Use!  
Protects Television Sets Against  
Lightning and Static Charges

## JFD SAFE TV GUARD

Fits Any Type of Twin Lead

No. AT102 for Regular Twin Lead  
No. AT103 for Oval Jumbo Twin Lead  
No. AT103 Also for Tubular Twin Lead  
BOTH Models Conform With Fire  
Underwriters and National Electrical  
Code Requirements for OUTDOOR  
installations.

**\$2.25**  
EACH

SIMPLE TO INSTALL . . . can be mounted directly on mast by strap fastening arrangement . . . or attached to any grounded object, at any position between antenna and set, outdoors or indoors. No stripping, cutting or spreading of wires necessary. Hardware furnished.

Look for the JFD Trademark

**JFD MANUFACTURING CO., Inc.**  
6127 16th Avenue, Brooklyn 4, N. Y.  
First in Television Antennas & Accessories

THE greatest possible transfer of energy from transmitter to antenna depends largely upon correct impedance match between the transmission line and antenna. Coaxial transmission line being available as surplus at reasonable prices has created among amateurs a great deal of interest in its possibilities for feeding beam antennas. The most popular of the coaxial cables is that bearing the Army-Navy type number RG-8/U.

RG-8/U coaxial is a medium-size, flexible cable for general-purpose use. The inner conductor consists of several (7/21 AWG) copper wires twisted together and buried in stabilized polyethylene dielectric material having a nominal diameter of 0.285 inch. The dielectric is shielded with copper braid, and the whole is covered with a tough coating of vinylite. The over-all nominal diameter of the finished cable is 0.405 inch. The cable has a nominal capacitance of 29.5  $\mu\text{f}$  per foot and a maximum operating voltage of 4,000 r.m.s. The rated surge impedance is 52 ohms.

The fact that this particular type of cable is abundant and cheap (about 4 cents a foot), is easily handled, will withstand weather, is flexible (it will wrap around a mast without shorting

or breaking), and can be buried is responsible for its popularity. Many people, however, have had difficulty in matching the impedance of the line to the center impedance of beam antennas.

The "delta" has been used, but its adjustment is critical. It is intended more for matching 300- to 600-ohm open-wire transmission lines to the antenna, and considerable time and temper can be consumed in adjustments. If the adjustment is not right on the button, the delta will radiate from the delta yoke.

The "T" match formula is  $T$  (inches) =  $870/f(\text{mc})$ . The result gives the dimensions of *one section* of the "T" match, from center to one end only. It is based on approximately 6 inches spacing between elements. The "T" is efficient and not too hard to adjust by comparison with the delta. However, inquiries as to dimensions of the "T"s" in use have brought a variety of answers.

The arguments pro and con regarding the use of coax aroused our curiosity about an easy method of impedance match *plus* a beam antenna designed so that it could be adapted to the impedance of any transmission line desired, as well as RG-8/U. Research revealed a wealth of helpful and interesting information.

RADIO-ELECTRONICS for

For instance, a four-element, close-spaced beam one full wave above ground with a simple dipole for a driven element has a radiation resistance at its center of approximately 6 ohms. A three-element, close-spaced beam under the same conditions has a radiation resistance of approximately 9 ohms. If we add another conductor to our simple dipole, making it a *folded dipole*, the approximate radiation resistance at center becomes 24 ohms for our four-element beam and 36 ohms for the three-element array.

There is a formula for this change of impedance, radiation resistance =  $N^2 \times$  radiation resistance of simple dipole driven element.  $N$  = the total number of conductors in the driven element. Thus, if we add two new conductors to the dipole of a four-element beam we get 9 times the original radiation resistance, 54 ohms.

The formula shows that by adding conductors the radiation resistance can be changed to almost any desired useable value. Adjustments are almost unnecessary. This is the easy method of

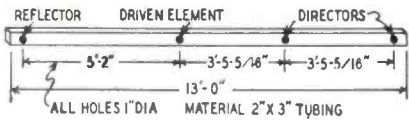

Fig. 1—Boom is made of hard aluminum.

impedance matching between antenna and transmission line. Either antenna wire or tubing can be used for the added driven elements.

The rest was a problem of versatility so that if it were decided in the future to change the transmission line to one with a different impedance, it could be done without rebuilding the beam antenna from scratch.

**Building the beam**

When purchasing the beam materials, be sure all parts are of the hard (24ST) aluminum stock to prevent the elements from sagging and blowing about in a high wind or bending under the weight of ice and snow.

The boom was made of 2x3-inch aluminum tubing. The elements are 1 inch outside diameter. The sections which slide onto the driven elements are 1 inch inside diameter. The tubing for the reflector and two directors should be not less than 16½ feet long. The central sections for the driven element are 12-foot lengths, and the end tuning sections are 6-foot lengths.

Since this beam was to have four elements close-spaced (0.1 and 0.15 wave length) and to operate on a frequency of 28.55 mc, the following dimensions were used in spacing the elements: reflector to driven element, 62 inches; driven element to first director, 41½ inches; first director to second director, 41½ inches.

The stock for the boom was laid out and drilled to take the 1-inch elements as in Fig. 1. The reflector and two directors were centered in these holes. A hole for a 10-32 screw was drilled through the top of the boom, through each element, and through the bot-

*Over 5,000,000 TV sets in use -  
Get in the Picture!*

EXPERIENCED TV TECHNICIANS ARE GETTING IN TELEVISION SERVICE RIGHT BY INVESTING IN TEST EQUIPMENT THAT PAYS OFF OVER AND OVER AGAIN IN PROFITS!...  
SUPREME TV TEST EQUIPMENT IS WORTH MANY TIMES THE PRICE!.....

**SUPREME**

**TELEVISION TEST SYSTEM**

Recognized—proven—praised—by leading • SET MANUFACTURERS • DISTRIBUTOR SERVICE MANAGERS • SCHOOLS • SUCCESSFUL TV TECHNICIANS • TV STATION ENGINEERS as the most efficient of all test methods.

Time saved in TV service is money earned. A technician will collect just as much for his services by locating the trouble in minutes with the SUPREME TELEVISION TEST SYSTEM as he will after spending valuable hours trying to get by with inadequate analyzing equipment.

Don't lose your profits waiting for a station test pattern to come on the air—HAVE YOUR OWN TEST PATTERN. Supreme TTS will supply the standard RMA synchronizing pulses just like the station and also provide a service test pattern. Not a "cross-hatch" signal but a real COMPOSITE VIDEO SIGNAL. Write for FREE brochure or—send \$1.00 for technical manual to Dept. TV-5, Supreme, Inc., Greenwood, Mississippi, U. S. A.

SUPREME TUBE SETTING SERVICE—Owners of Supreme Tube Tester Models 589, 599, 504-B and "A" series can obtain settings for late AM, FM and TV receiving tubes by ordering new ROLL CHART. State number on old chart when ordering. Price of chart \$1.17.

**SPEAKER CONING**

2½"	... \$1.40	6½"	... \$1.65	13½"	... \$4.00
3½"	... 1.40	7"	... 1.95	15"	... 4.00
4"	... 1.40	7½"	... 1.95	18"	... 7.50
4½"	... 1.40	8"	... 2.20	2x3"	... 1.40
5"	... 1.50	10"	... 2.70	4x6"	... 1.90
5½"	... 1.50	11"	... 3.00	5x7"	... 2.20
6"	... 1.65	12"	... 3.00	6x9"	... 2.50

We feature fastest service, finest quality components, careful workmanship, full guarantee. We ship in heavy duty individual cartons for convenient storage and safe shipment. All speakers Sound Tested. Special services: 12 and 50 ohm voice coils for Intercoms. Wet-resistant cones for Drive-In theatres. All prices FOB. Jobber inquiries invited.

**ARROW RECONING**

127 E. First St. Duluth 2, Minnesota

**NEW CONDENSER TESTER**



**Finds Intermittent Condensers Instantly**

Pres-probe's sliding tip with variable resistance prevents condenser heating. Tests with power on. Requires no adjustment. Stops guesswork. Saves time. Convenient probe size (7½" long). Satisfaction guaranteed.



See Your Dist. or Order Direct

**PRES-PROBE CO.**

2326 N. THIRD ST., MILWAUKEE 12, WIS.

# CIRCLE X ANTENNA

ENGINEERED TO PROVIDE  
**CLEAR SHARP PICTURES ON ALL CHANNELS**  
 COMPARE CIRCLE-X TO ANY OTHER TV ANTENNA

No other antenna combines all the mechanical and electrical features engineered into the Circle-X.

The high gain of the Circle-X is equal to stacked arrays. It is made of light weight corrosion resistant aluminum alloys that stand up in all atmospheric conditions.

When you use Circle-X you stock only one type of antenna for all jobs. It has one wire lead-in and weighs only 2½ lbs.

We urge you to compare Circle-X TV Antennas to any other TV antenna on the market.

Use Circle-X on your next tough TV installation. It may save you a lot of "no profit" call backs.



PAT. PEND.

DEALERS: Air Express or Parcel Post Special Delivery direct from factory to you through your jobber, if he cannot supply you with the Circle-X from his stock.

**CIRCLE-X ANTENNA CORP.**  
 509 MARKET ST., PERTH AMBOY, N. J.

**CIRCLE X**  
 ANTENNA CORPORATION

## BUILD 15 RADIOS . . . Only \$14.75

- ABSOLUTELY NO KNOWLEDGE OF RADIO NECESSARY
- NO ADDITIONAL PARTS NEEDED
- EXCELLENT BACKGROUND FOR TELEVISION

The PROGRESSIVE RADIO EDU-KIT will help you, if you want an EDUCATIONAL AND INTERESTING HOBBY, or if you want to get into a WELL-PAYING BUSINESS, or if you want to INCREASE YOUR KNOWLEDGE OF RADIO.

Absolutely no knowledge of radio is necessary. The PROGRESSIVE RADIO EDU-KIT is the product of many years of teaching and engineering experience. The detailed instructions and quizzes are clearly written and illustrated, so that they can be understood by anyone between the ages of 12 and 80.

The PROGRESSIVE RADIO EDU-KIT is not merely a collection of radio parts accompanied by a radio diagram. IT IS PRACTICALLY A RADIO COURSE, offered at a mere fraction of its real value. You will be taught to build radios in a progressive manner. First, you will build a very simple 1-tube receiver. The next set is a little more advanced. Gradually you will find yourself constructing elaborate radio sets, and doing work like a professional radio technician. Every part is illustrated. EVERY STEP INVOLVED IN BUILDING THESE SETS HAS BEEN CAREFULLY PLANNED. YOU CANNOT MAKE A MISTAKE.

Each of the 15 radios you will build operates on 110-120 volts, AC or DC. These sets have been designed to teach you the PRINCIPLES OF RADIO. Therefore, you will build a variety of circuits. The PROGRESSIVE RADIO EDU-KIT is EXCELLENT FOR LEARNING THE PRINCIPLES OF RECEIVER, TRANSMITTER, AND AMPLIFIER DESIGN. It is used in many Radio Schools and Colleges in U.S.A. and abroad. It is used by the Veterans Administration for veteran training.

Quizzes are provided as part of the PROGRESSIVE RADIO EDU-KIT. They will be corrected by our staff at no extra cost.



FREE 1950 EXTRAS:

ELECTRICAL AND RADIO TESTER  
 SCREWDRIVER  
 BOOK ON TELEVISION  
 GENEROUS HANK OF WIRE

ELECTRIC SOLDERING IRON  
 ALIGNMENT TOOL  
 SPOOL OF ROSIN CORE SOLDER  
 MEMBERSHIP IN RADIO-TV CLUB

ORDER YOUR PROGRESSIVE RADIO KIT TODAY, OR SEND FOR FREE "KIT-KATALOG"  
 POSTAGE PREPAID ON CASH ORDERS. C.O.D. ORDERS ACCEPTED IN U.S.A.

**PROGRESSIVE ELECTRONICS CO.**

497 Union Ave., Dept. RE-35  
 Brooklyn 11, New York

Italian interest in television is attested by *Televisione Italiana*, a new magazine published in Turin and devoted entirely to technical television subjects.

The first issue carries a story, signed by the editors, discussing the television demonstrations carried on in Turin last

October. Two complete transmission systems were set up: one furnished by the French and conforming to the new French 819-line standard; the other installed by General Electric, using a 625-line standard, with typical American circuits. Receivers were scattered about Turin.

tom of the boom. A hole slightly larger than the head of the 10-32 brass screw was redrilled in the top of the boom to allow the bolt head to rest firmly against the top of the element tube. This will prevent the wind from causing excessive vibration of the elements and

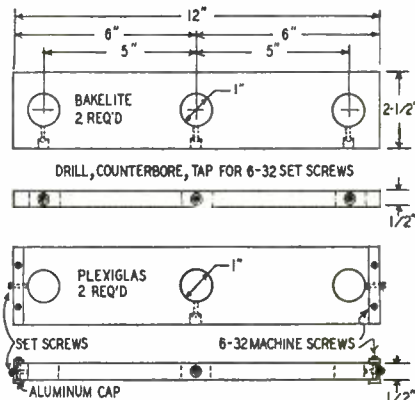
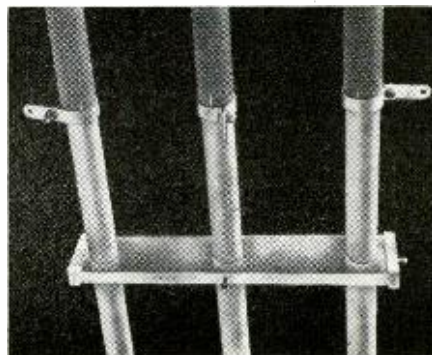

Fig. 2—Spacers for the triconductor.

also prevents sag when the screw is drawn up tight.

Fifty-two ohm coaxial cable for the transmission line necessitated the use of a *three-conductor* folded dipole in order to obtain an impedance match. Therefore two pieces of Plexiglas 12 x 2½ x ¾ inches and two pieces of Bakelite of the same dimensions were drilled as shown in Fig. 2. The Bakelite, being heavier, was used as the spacing medium at the boom and was securely bolted in place with 10-32 brass screws. The center hole in the Bakelite was carefully aligned with the 1-inch hole drilled in the boom to take the driven element (see photo). Next, the three conductors of the driven element were passed through the holes provided for them and secured with 6-32 setscrews. It is important to note here that the conductor that is to be driven is *not split at this time, but is left intact*. This is to expedite alignment of the three elements so the matching sections on the ends of the triconductor driven section will slide easily without binding.

The Plexiglas spacers are next placed on the three conductors of the driven section. The sliding sections can now be slid over the outer ends of the central triple section. Slide them on at least halfway to give firm support for the end shorting bars (see photo), which



Aluminum caps add strength to spacer.

RADIO-ELECTRONICS for



can now be added to each opposite end of the sliding section. These bars can be shaped to fit snugly on the tube ends. The shorting bar and each of the tube ends are drilled while in position to take 8-32 brass screws. C clamps should be used to prevent slippage. Once the shorting bars have been bolted in position and the sliding sections aligned, the unit should be removed and the ends opposite the shorting bars slotted three ways with a hacksaw to a depth of 1 inch. Circular clamps should be placed over the slotted ends and the sliding sections replaced on the triple sections.

The ends of the two directors and the reflector should also be slotted in the same manner and circular clamps placed over them. Inserts about 6 inches long of aluminum tubing of 3/4-inch outside diameter are slid into the ends of the two directors and the reflector for tuning. They are held in position with the circular clamps.

The tube that is to be connected to the transmission line is now cut in two and separated by a half inch. Circular clamps placed over these ends serve as connectors for the coax fitting shown in the photo on page 85. This fitting is

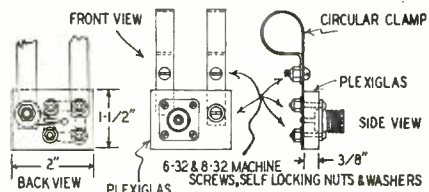
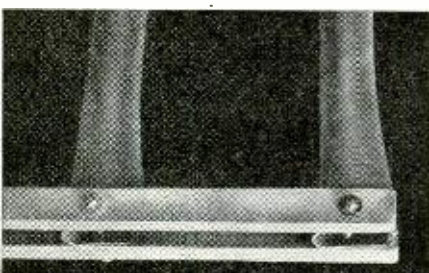

Fig. 3—Dimensions for coax fitting.

easily made from a piece of Plexiglas, a coax connector, and necessary brass screws. Fig. 3 gives all the necessary dimensions.

**Tuning the beam**

Before the various sections are set to the resonant frequency the parts that fit together by sliding should be thoroughly cleaned until they are shiny bright. An efficient way to do this is to purchase two brass wire brushes of the sort commonly used to clean shotguns. One end has a shank threaded to take a ramrod. When these threads are



Detail of shorting bars for the ends.

ground or filed off, the shank fits nicely into the chuck of a 1/4-inch hand power drill. With this power-driven wire brush, the inside as well as the outside of the tubes can be cleaned of all aluminum oxide, affording good electrical connections.

The elements can now be adjusted for the frequency upon which you wish

# CORROSION... the iron curtain of TV reception

RAIN • SNOW • WIND • SEA AIR

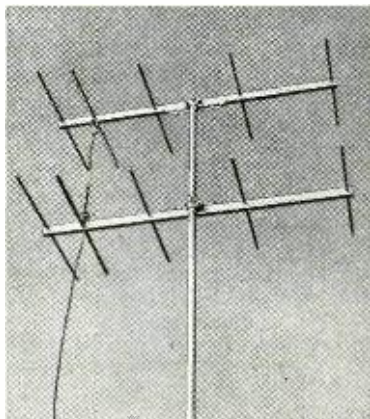

One of the major reasons for poor television reception is a corroded antenna . . . and in most cases you won't know when your antenna is corroded.

Corrosion changes the electrical characteristics of the antenna . . . results in imperfect — even poor — reception.

Only with antennas that do not corrode can you be sure of good reception.

Tel-a-Ray antennas can't corrode! They are constructed of Dural, with stainless steel fittings . . . all elements sealed by the exclusive Tel-a-Roll process.

You get perfect television reception all the time. Whether you are replacing a worn antenna or installing a new one — buy Tel-a-Ray.

## Tel-a-Ray Antennas

"FIRST—BECAUSE THEY LAST"

**TEL-A-RAY ENTERPRISES, INC.**

P. O. BOX 322, DEPT. C, HENDERSON, KY.

**Car Shaver Motor**

Use your electric shaver in your car. Dynamotor will supply 110-120 Volt DC approx. 15 Watts from 6 Volt DC auto battery and will operate most types of AC-DC shavers. Order No. RE-5250. Price—only \$2.00

**Sewing Machine Conversion Kit**

It's easy to convert your treadle type home sewing machine to an up-to-date electric machine. This big value kit comes complete with motor, rheostat control, light, adapter bracket, and instructions. Brand New. \$12.95 Order Stock No. RE-320. Price—only \$12.95

PHONOGRAPH MOTOR only—110 Volt 60 cycle, 78 RPM for automatic record changers. \$1.50

GEAR TRAIN MOTOR—Low inertia reversible type. Can be used to operate small displays, models, etc. Operates from 12 V. AC with use of condenser. Normally operates 26 Volt 400 cycle. Motor 588 RPM; low speed 14 RPM; separate gear 7 1/2 RPM. Complete motor, gear train, condenser, & instructions. \$2.50

MODEL MOTOR—12 Volt AC-DC, 1/2" double end shaft. Motor size: 2 1/2" L x 2 1/2" W x 1 1/2" H. Price. \$1.50

HAND TOOL MOTOR—12 Volt AC-DC 5600 RPM. Size: 3 3/4" L x 1 1/4" D with splined shaft 1/2" D x 1/2" L Price \$2.95

6 VOLT AC OR DC MOTOR—Ideal for auto heaters, defrosters, fans, models, etc. Used by Govt. in aircraft. Shaft size: 1/4" x 3/8". Price \$1.50

**DYNAMOTORS AND INVERTERS**

Write us and tell your requirements. We have big stock to select from.

TRANSFORMERS—110 Volt 60 cycle Primaries: Sec. 12 V. 1 amp. \$1.50 Sec. 24 V. 2 amps. \$2.25 Sec. 24 V. 1 amp. 1.95 Sec. 24 V. .5 amp. 1.50 Sec. 36 VAC. 2.5 amps. \$2.95 Sec. 14-14 or 28 V. 7 1/2 or 15 amps. 4.95

SELSYN TRANSMITTER & INDICATOR SYSTEM—Ideal for antenna direction indicator to remote position. Complete with Autosyn Trans. 3" I-81 Indicator, Transformer, and instructions. Price \$6.75 Autosyn Trans. only: \$2.95 Plug t/1-81: \$1.00

MARK II B-19 TRANSMITTER & RECEIVER 15 TUBE SET 2-8 MC.; 240 MC.; AND INTERCOM. FOR MOBILE OR STATIONERY USE!

Set transmits and receives 2 to 8 MC. Phone, C W and M C W 25 Watt Master Oscillator Control. Transmits and receives 240 MC. Phone. Also an intercommunicating set. Comes complete with 15 Tubes, Headset, Micro., Antennas, Control Box, 12/24 Volt Power Supply, and instructions—ready to operate. Set size: 27" x 10" x 13 1/4". Price—USED (TESTED) \$39.50

Address Dept. RE • Prices F.O.B., Lima, Ohio • 25% Deposit on C.O.D.'s • Minimum Order \$2.00

**FAIR RADIO SALES**

132 SOUTH MAIN ST. LIMA, OHIO

**NOW... A TELEVISION TOWER YOU CAN AFFORD TO BUY!**

All steel, welded construction, made of 1/2" Thinwall conduit, 1/2" Rod Braces, and 1" Steel Bands. Made in 10 Ft. triangular shaped sections, tapered, 18" at base to 3 1/2" at top. Hinged mounting plates and 2" mounting hole for Mast, with Guy Rings. 30 foot Tower is self supporting when mounted on ground. Weight: 75 lbs. Towers dipped in aluminum paint for weatherproof protection and long life. PRICE: 30 Foot TOWER \$38.40 delivered anywhere U.S.A. Additional 10 Foot Sections, delivered . . . Each \$11.70 GUY WIRE: 3/32" 7 x 7 Strand Aircraft Type, only 2c per Ft. WIRE CABLE CLAMPS: . . . 10c Ea. TURNBUCKLES: 5 1/2" @ 25c Ea.; 9 1/2" @ 70c Ea.

**PM FIELD DYNAMOTORS: POWER SUPPLY**

Completely filtered 12/24 Volt input; output 275 Volt 110 MA. & 500 Volt 50 MA. housed in a metal case 8" x 6" x 10". Contains: 2 PM Dynamotors (as listed below), 2 Switches, 12 Cond., Fuses, Light, Brushes, Chokes, Resistors, Plugs, etc. Shipping weight: 62 lbs. \$5.00 Order No. RE-#3

**PM FIELD DYNAMOTORS**

12/24 V. input; output 275 V. 110 MA. \$3.95 12/24 V. input; output 500 V. 50 MA. \$2.95

**WHIP ANTENNA EQUIPMENT**

**MAST BASES—INSULATED:**

MP-132—1" heavy coil spring, 2" insulator. Overall length: 11 1/2". Wt. 2 1/2 lbs. Price \$3.95 MP-22—Spring action direction of bracket. 4" x 6" mounting. Price \$2.95

**MAST SECTIONS FOR ABOVE BASES:**

Tubular steel, copper coated, painted, 3 foot sections, screw-in type. MS-53 can be used to make any length. MS-52-51-50-49 for taper. Any section. 50c Ea. BAG BG-56 f/carrying 5 sections \$5.00

BC-1206 RECEIVER—200-400 KC. 5 Tubes. Operates from 24-28 VDC. If Freq. 135 KC. Size: 4"x4"x6" LN \$6.95

POWER SUPPLY KIT—110 Volt AC to 24 VDC. \$6.95

MARKER BEACON RECEIVERS—Receive 75 MC. modulated signal (can be varied from 62 to 80 MC.) which actuates self contained sensitive relay and can be used to operate equipment from a remote point. Requires 12-24 Volt DC only:

BC-357—2 Tubes—USED: \$2.95 BC-1023—4 Tubes—NEW: \$4.50 BC-301—Similar to above, Less Tube—USED: \$1.95

## No. 630 Chassis Still the Best in TV NOW . . . More Outstanding than Ever!

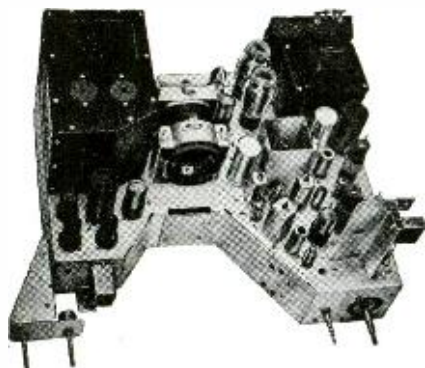

### KNOWN MFR. . . . LICENSED BY RCA

STANDARD 10" & 12 1/2" (29-tube chassis) engineered in strict adherence to the genuine RCA No. 630. DELUXE 16" & 19" (31-tube chassis) have added features of voltage doubler, keyed AGC and 70° deflection systems. CHASSIS delivered (as pictured) ready to play with all tubes, hardware, knobs and choice of 5"x7" or 12" speaker (less CRT). Kit delivered complete with 29 tubes and instructions (less CRT)

### OFFERED TO YOU AT NEW LOW DEALERS' PRICES

- 19" —Deluxe Chassis . . . \$ 169.67
- 16" —Deluxe Chassis . . . 159.59
- 10 or 12 1/2" Std. Chassis . . . 149.97
- 10 or 12 1/2" Std. Kit . . . 129.44
- 19" METAL CRT, Known brand . . . \$66.97
- 19" GLASS CRT, Known brand . . . 62.94
- 16" METAL CRT, Known brand . . . 39.89
- 16" GLASS CRT, Known brand . . . 37.82

### PARTS FOR # 630 IN COMPLETE SETS

- VIDEO AND I.F. KIT (19 items) . . . \$ 7.84
- ELECTROLYTIC CONDENSER KIT (6 cond.) . . . 7.37
- PAPER CONDENSER KIT (37 condensers) . . . 4.28
- CERAMIC CONDENSER KIT (28 condensers) . . . 3.02
- MICA CONDENSER KIT (12 condensers) . . . 1.90
- CARBON RESISTOR KIT (107 resistors) . . . 4.98
- WIREWOUND RESISTOR KIT (4 resistors) . . . 2.31
- OCTAL WAFER SOCKET KIT (13 sockets) . . . .72
- MIN. WAFER SOCKET KIT (10 sockets) . . . .63
- MIN. MOLDED SOCKET KIT (2 sockets) . . . .22
- KNOB KIT, decal included (8 knobs) . . . .98
- BRACKET AND SHIELD KIT (18 brackets) . . . 8.63
- TERMINAL STRIP KIT (19 terminal strips) . . . .59
- VOLUME CONTROL KIT (9 volume controls) . . . 6.19
- COMPLETE TV TUBE KIT, less CRT (29 tubes) . . . 21.27

## 16" TELEVISION CONVERSION KIT

Modernize Your 10" #630 in One Hour

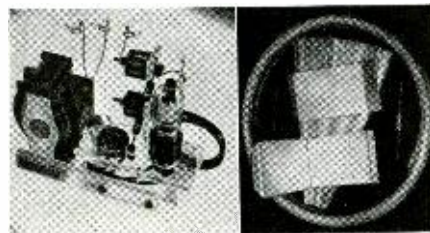

- VOLTAGE DOUBLER DELUXE
- WIRED SUB-ASSEMBLY
- FLYBACK TRANSFORMER 21T5
- 1B3/8016 TUBE
- SET OF MOUNTING BRACKETS
- PLASTIC SLEEVE & RING
- SET OF RESISTORS & CONDENSERS

Complete with Simple, Easy to Follow Instructions  
**\$19.63**

**BROOKS RADIO DIST. CORP.**  
80 VESEY ST., DEPT. A NEW YORK 7, N. Y.

to operate. Using the formulas given in handbooks, the element lengths of our own antenna were calculated for a frequency of 28.55 mc. The lengths of the various elements (tip to tip) are as follows: reflector, 17 feet 2 3/4 inches; driven element, 16 feet 4 1/2 inches; first director, 15 feet 9 inches; second director, 15 feet 1 1/2 inches.

Once the elements have been fastened to the boom and adjusted for length, we can locate the point on the boom at which the antenna will balance perfectly. Mark this point. It is the place to which we will bolt the plate to seat the pipe flange into which the supporting mast will thread.

Measure the diameter of the pipe flange and, adding at least 1 inch on either side, cut a square piece of 1/8-inch 24ST flat stock. Place the center of the flat stock over the balance mark on the boom; drill and bolt the flat piece to the underside of the boom with 10-32 brass or galvanized screws. This will provide a strong, flat base to which the pipe flange can be bolted.

Once the pipe flange has been secured, the beam elements should again be measured and checked. If everything checks perfectly, the sliding section of each of the elements is drilled to take galvanized, self-threading screws. The holes should be slightly smaller than the screws to provide a sharp bite as they cut their own threads. This will insure perfect electrical connections as well as prevent the tuning sections from becoming loose once the beam has been installed where it might be inaccessible. These screws should pass through the circular clamps as well as the elements. If there is any play where the elements pass through the boom, cut small wedges from scrap tubing and carefully tap them firmly into any spaces. It is absolutely imperative there be no scraping parts in the antenna. Metal scraping against metal in any part of the array will cause noisy reception.

Before the antenna is raised to its final position, it should be given an undercoat and a coat of high-grade lacquer. When the lacquer is thoroughly dried, the antenna may be raised and

installed. While it is in position, four holes should be drilled through the skirt of the pipe flange and through the pipe which screws into it. These holes should be tapped to take brass machine screws. The mast and flange are firmly held together and yet easily disassembled if necessary.

The antenna is now ready for the transmission line to be connected and tests made, as described in any handbook, for standing-wave ratio (see "The Coax Twin Lamp," QST, November, 1948). Trim the coaxial line carefully if tests indicate that it is necessary.

For optimum efficiency the lowest permissible height above ground for the antenna is one full wavelength. (See handbooks for the curves on the effect of height.) To tune a beam 6 or 8 feet above ground and then raise it to a height of 32 feet cancels all effort at reaching a point of high forward gain or front-to-back ratio. If it is possible to tune the beam in its working position, the story can be different. However, it should be kept in mind that much time was spent in experiment and tests by engineers with considerably more experience and background on the antenna subject than we are apt to have. The practical formulas were arrived at from observations made for optimum performance at the most efficient height above ground.

These observations conclude that if the antenna can be placed one full wave above ground and fully in the clear away from buildings and trees it is best to build the antenna, calculate the element lengths as per formula, and install the antenna where it will eventually work without further adjustment except on the transmission line.

It is interesting to note that according to the available information, a four-element beam one full wave above ground has a radiation angle of approximately 15 degrees. By raising the antenna to a height of two full waves the radiation angle can be lowered to approximately 8 degrees. For most efficient operation in the 10-meter band the angle of radiation should be from 8 to 15 degrees. Approximately 10

### BEAM TUNING TABLE

FREQUENCY (MC)	REFLECTOR LENGTH	DRIVEN-ELEM. LENGTH	DIRECTOR NO. 1 LENGTH	REFLECTOR TO DRIVEN-ELEM. SPACING	DIRECTOR NO. 1 TO DRIVEN-ELEM. SPACING
28.70	17'2"	16'3"	15'7 1/2"	61 1/2"	41 3/8"
28.85	17'3/4"	16'2 1/2"	15'7"	61 1/4"	40 3/32"
28.90	16'11"	16'1 1/4"	15'6"	61"	40 13/16"
29.15	16'10"	16'3/8"	15'4 3/4"	60 5/8"	40 1/16"
29.30	16'9 1/8"	15'11 1/8"	15'4"	60 1/8"	40 3/32"
29.45	16'8 13/32"	15'10 1/4"	15'3"	60"	40"
29.60	16'7 13/16"	15'9 19/32"	15'2 3/8"	59 7/8"	39 7/8"
29.70	16'6 1/2"	15'8 1/32"	15'1 1/16"	59"	39 5/8"
14.00	35'1 1/4"	33'4 13/16"	32'1 13/16"	10'6 3/8"	7'1"
14.10	34'10 13/16"	33'2"	31'10 13/16"	10'5 3/4"	6'11"
14.20	34'7 1/4"	32'11"	31'7 1/4"	10'4 1/2"	6'10 13/16"
14.30	34'4 13/16"	32'8 13/16"	31'5"	10'3 19/32"	6'9 3/4"
14.40	34'2 13/32"	32'6"	31'2 1/2"	10'3"	6'9 5/8"



# BIG OR SMALL RCP has them all!

## GIANT SIZE METER MULTITESTER MODEL 462



20,000 Ohms per Volt D.C.  
5,000 Ohms per Volt A.C.  
**NO FREQUENCY ERRORS**

Unusual because of the many desirable features that are combined in one instrument. The size of the meter, 6 3/4", provides a very large scale with excellent legibility so important for bench work.

Uses germanium crystal rectifier which has no frequency error for output measurements or even high radio frequencies. Uses individual unit cells for ohmmeter. Easy and economical to purchase and replace—snap into terminal clamps—no soldering.

Model 462 Multitester is a beautiful large instrument with 6 3/4" meter, bakelite panel and oak case. Size 4 1/4" x 8 1/2" x 10 3/4". Weight 5 lbs.

**RANGES**  
D.C. Voltmeter 0/2.5/10/- 200/200,000 0/20 megohms.  
50/250 1000/5000 volts. Decibel Meter—10 to 55 db.  
A.C. Voltmeter 0/2.5/10/- Meter of 50 microampere  
50 250 1000/5000 volts. sensitivity permits current  
D.C. Milliammeter 0/10/- readings of less than 1  
100 500 milliamperes. microampere.  
D.C. Microammeter 0/100 Shunts and multipliers are  
microamperes. Ohmmeter 0/- calibrated to 1% accuracy.

Model 462 Multitester is a beautiful large instrument with 6 3/4" meter, bakelite panel and oak case. Size 4 1/4" x 8 1/2" x 10 3/4". Weight 5 lbs.

Net Price .....\$41.50

Model 462P comes in a portable hinged cover oak carrying case having a tool compartment and includes deluxe pencil prod test leads. Size 5 1/2" x 8 1/2" x 11 1/2". Weight 6 lbs.

Net Price .....\$45.95

## POCKET SIZE METER MULTITESTER MODEL 449A

Versatile multi-tester remarkably accurate. It's tops for general circuit testing and for speed in trouble-shooting. Uses a 3" square meter at 5,000 ohms per volt with a basic movement of 200 microamperes. Batteries are mounted in special spring clips readily accessible for replacement—no wires to solder. Combines 6 instruments in one small unit.



**RANGES**  
DC Volts: 0-5-50-250-1000 Volts.  
AC Volts: 0-5-50-250-1000 Volts.  
DC MA: 5-10-100-1000 MA.  
Ohms: 0-2000-20,000-0-2-2. Megohms.  
Decibels: -6 to +52 dB in four ranges.  
Output Meter: 0-5-50-250-1000.

Model 449A—Pocket Multitester supplied in black metal case complete with self-contained batteries. Ready to operate. Size 5 1/2" x 3 1/8" x 2 1/4". Weight 1 1/2 lbs.

Net Price .....\$24.50

Model 449AP—Same as 449A but supplied in portable oak case with leads.

Net Price .....\$28.50

BUY IT FROM YOUR JOBBER  
Exhibited at Radio Parts Show, Chicago  
Write for Catalog RC 5

**RADIO CITY PRODUCTS CO., INC.**  
152 West 25th St. New York 1, N. Y.

# Frequency Control Unit For Citizens Band Tests

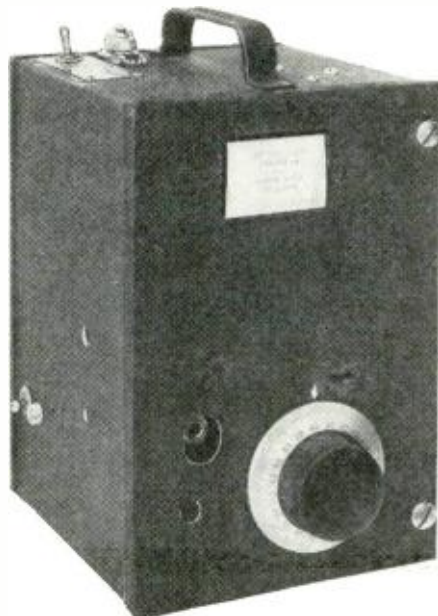

"Gold-Plated Special" is a signal source and frequency meter

By I. QUEEN

The double-check frequency control unit.

THE citizens' band is attracting a tremendous amount of attention because it is the only band on which the untrained individual will be permitted to operate without code test, radiophone license, or other test except a probable short examination in traffic rules and the regulations covering his equipment. Thus it will be open to large numbers of persons who would otherwise be unable to use two-way radio.

Designing receivers and transmitters for this u.h.f. band is by no means easy. Many technicians and amateurs are attempting to modify Army-Navy surplus units to operate in the 460-470-mc band, so far without real success. The FCC has—correctly—set stiff frequency and stability tolerances for citizens' band operation, and the designer is finding it difficult to stay within the specifications.

The indispensable first step in successful construction or conversion of u.h.f. equipment is a reliable signal source and an accurate method for measuring frequency. Use of very high harmonics of crystals and v.f.o. units is not practical at such high frequencies. Besides, a crystal is limited to a very narrow range and dozens would be needed fully to cover the band.

This article will be divided into two parts: one will describe the signal source, and the other a method for measuring its frequency.

### Signal source

Most readers are aware of the tremendous difficulties awaiting the designer of u.h.f. signal generators. The

problem is eased somewhat by using the second (or even third) harmonic of an oscillator. Many technicians now use equipment of this type in television servicing, for example. Such operation is entirely satisfactory and is well justified for work in the citizens' band. Of course building a generator even for 235 mc is a difficult project for the home or small lab.

Fortunately an excellent one is now available for a few dollars on the surplus market—the so-called "gold-plated special," a Navy signal generator putting out a signal in the range 234-258 mc. This is being sold with two type 955 acorn tubes but without batteries. It is housed in a metal box with handle. Its rear compartment has plenty of room for an a.c. power supply.

This portable test set was used by the Navy to align homing adapters and command receivers used aboard Navy planes for picking up homing signals to enable the planes to find their "home" carrier after completing a mission. The homing signal was transmitted in the range between 234-258 mc with amplitude modulation at 710 kc. The homing

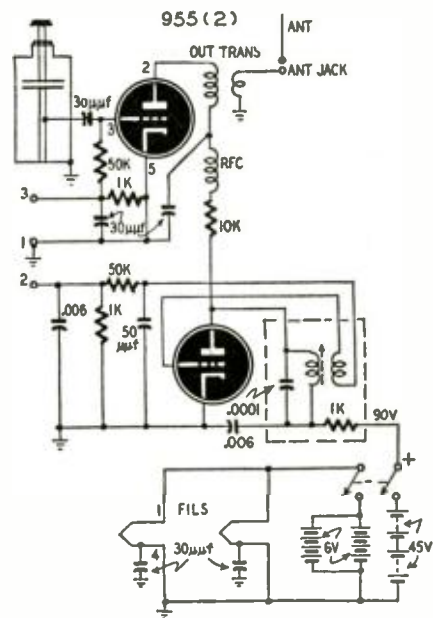
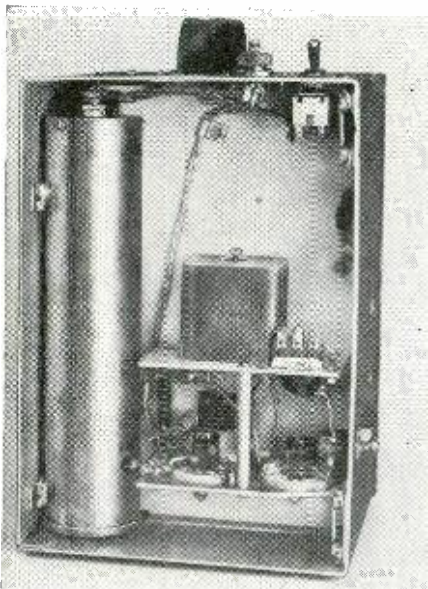

Fig. 1—Schematic of the Navy test set. RADIO-ELECTRONICS for

adapter picked up the v.h.f., demodulated it and passed the 710-kc signal to the main command set where it was reproduced. The "gold-plated special" is a test oscillator which simulates the actual transmitter and was used to align a group of receivers and their adapters. Obviously the signal is stable, and reliable and has little drift, since the Navy sought and obtained the best instrument possible that could be manufactured. The safety of men, planes, and missions required it.

**Possible adjustments**

The portable test set has two acorn tubes. (Fig. 1.) One is used in the tuned-grid, tuned-plate v.h.f. circuit. A gold-plated coaxial resonator tunes the grid circuit. The plate is resonated by a small coil without tank capacitor. Because of its very high Q, the resonator largely determines frequency. The plate coil does, however, affect the v.h.f. By compressing it slightly, the lower limit may be reduced so that the second harmonic covers the entire citizens' band. The modulator tube (at the right) may be removed, thus eliminating the modulation. As already mentioned, an a.c. power supply may be built into the rear compartment. No other changes are required or recommended.



High-frequency section, internal view. The gold-plated coaxial resonator is at left and the 710-kc transformer near the center of the case. Below are the two 955 r.f. and a.f. oscillator tubes.

The v.h.f is adjusted by rotating the screw at the top of the coax resonator. This can be done with a special wrench supplied with the instrument. This screw controls a variable capacitor inside the resonator. The tuning is fixed by tightening the locknut.

After the oscillator is tuned and locked in place, we have the equivalent of a "crystal" at v.h.f. The second harmonic signal is stable and can be maintained for long periods with low drift. If an a.c. power supply is to be used, it should be regulated for best results. Of course batteries add greatly to

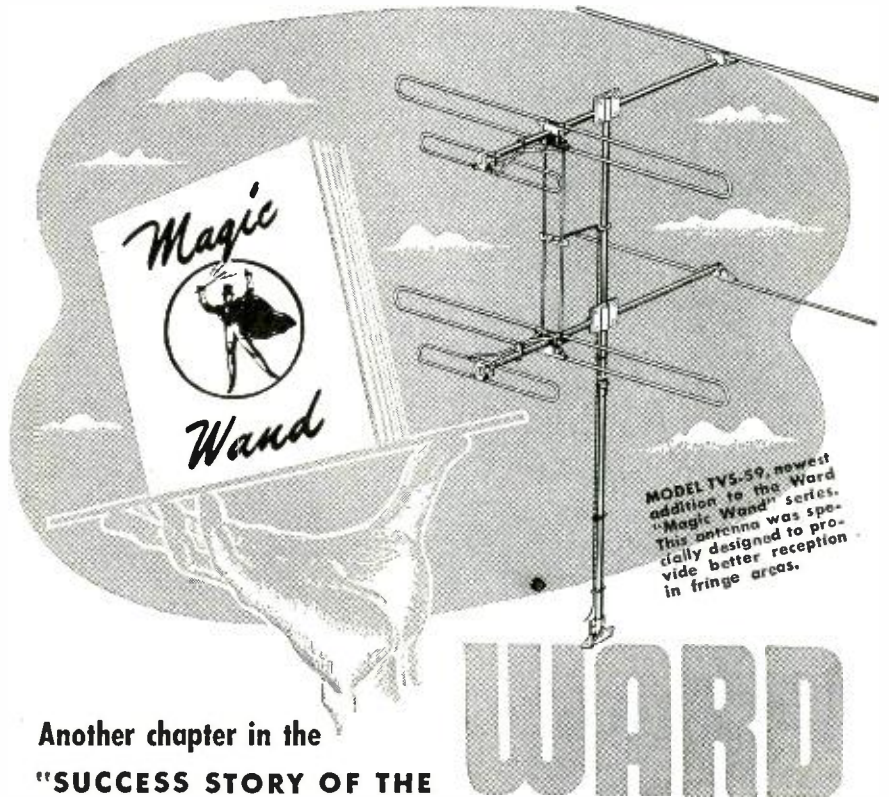

MODEL TV5-59, newest addition to the Ward "Magic Wand" series. This antenna was specially designed to provide better reception in fringe areas.

**Another chapter in the "SUCCESS STORY OF THE MAGIC WAND ANTENNAS"**

More than a thousand power lines snapped! Street car service disrupted by broken trolley wires! Thousands of tree branches crashed to the ground!

But the Chicago area's worst ice storm did not affect a single Ward Products "Magic Wand" TV antenna.

"Magic Wand" antennas are made of Perma-Tube, a special alloy expressly developed for Ward Products by the Jones & Laughlin Steel Corporation. Perma-Tube is a rugged alloy designed to withstand the harmful, corrosive effects of ice, sleet, snow, wind, and rain.

In good weather or bad, your TV set will give you the best reception if you have a Ward "Magic Wand" antenna. Tests have proved a medium-priced TV set with a good antenna performs better than an expensive set with a cheap antenna.



Write for our free booklet, "The Story of the Magic Wand." It contains interesting, authoritative information about TV and FM antennas.

**WARD PRODUCTS CORPORATION**

1523 E. 45th STREET, CLEVELAND, OHIO

Division of the Gabriel Company

Ward is the largest and oldest exclusive maker of television and auto radio aerials.

**WANTED TO BUY**

Large and small quantities of new or used electronic government or manufacturers' surplus tubes and equipment. Highest prices paid. State quantity, condition and best price in first letter.

Box No. F-2 c/o Radio-Electronics  
25 West Broadway  
New York 7, N. Y.

**EASY TO LEARN CODE**

It is easy to learn or increase speed with an Instructograph Code Teacher. Affords the quickest and most practical method yet developed. For beginners or advanced students. Available tapes from beginner's alphabet to typical messages on all subjects. Speed range 5 to 40 WPM. Always ready—no QRM.



**ENDORSED BY THOUSANDS!**

The Instructograph Code Teacher literally takes the place of an operator-instructor and enables anyone to learn and master code without further assistance. Thousands of successful operators have "acquired the code" with the Instructograph System. Write today for convenient rental and purchase plans.

**INSTRUCTOGRAPH COMPANY**

4701 Sheridan Rd., Dept. RC, Chicago 40, Ill.



cover of the test oscillator with metal spacers. When the cover is closed, the box is screwed down to the base of the portable case. It is necessary to space the rear cover from the calibrator box panel because a velvet vernier dial is used and this cannot be mounted in the usual way.

Essential parts of the calibrator are an acorn tube and socket, a slug-tuned coil, straight-line frequency capacitor, and temperature-compensating capacitors. A type AR-5 (National) coil permits adjusting the frequency range as required. The SLF capacitor was chosen because it has a 270-degree rotation. Actually, a linear frequency variation may be obtained by using semicircular plates but these have only 180-degree rotation. Furthermore it is difficult to obtain a rugged, noiseless unit in the required capacitance range (about 12  $\mu\text{f}$  minimum to maximum). The SLF capacitor permits allocating nearly 180 degrees of rotation to the citizens' band measurements and leaves room for measuring frequencies down to 440 mc (on the twelfth harmonic, of course). The calibrator frequency chart is shown in Fig. 3. Frequencies between 468-470 mc may be measured to within .01% because of the very wide bandspread. This is the region reserved for class-A stations.

If the v.h.f. oscillator uses the same power supply as the calibrator, no other coupling is required. The beat note will sound rather rough, a con-

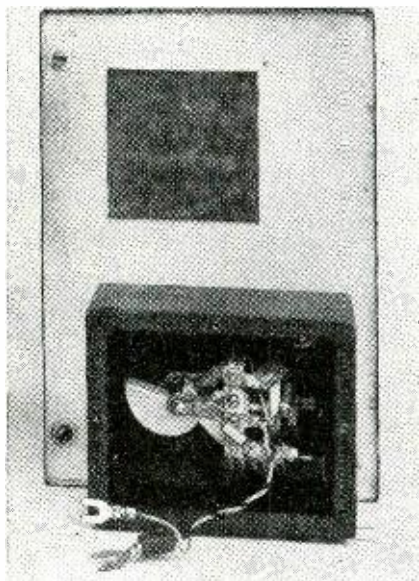

The low-frequency unit, internal view. Convenience because no modulation is required. This is not necessarily a mark of instability. A change of 2 kc out of 230,000 is less than .001%. For the same reason drift will sound very noticeable. However, total drift over a period of 5 hours (but not counting the first 5 minutes) is less than 0.22 mc, about 0.1%. Most of the drift takes place the first 15 minutes or so. In any case the drift is not a serious problem. The v.h.f. oscillator is merely a signal source, and we can measure its frequency as often as we wish to determine its exact value.

MAY, 1950

# JACKSON

## Announces a Sensational, New 5 Inch Oscilloscope

**Band Width to 4.5 megacycles!  
High Sensitivity of .018 volts-per-in.**



Now, for the first time—thanks to an amazing electronic discovery—Jackson has combined in one oscilloscope both wide band width and High deflection sensitivity. By merely flipping a switch you can choose from one of three sensitivity ranges, or one of three other band width ranges. Here is a fine instrument, perfectly suitable for laboratory analysis, yet well within the price range of the average radio serviceman.

The new Jackson Model CRO-1 is in production right now! It is priced at only \$195.00 net. A special high-frequency signal tracing demodulation probe is also available at \$9.95. Get your order in today!

### *Just look at these Features*

**Wide Band Amplifier:** Easily usable to a full 5 megacycles. Flat within plus or minus 1.5 db. from 20 cycles to 4 megacycles.

**Deflection Sensitivity:** Vertical amplifier, .018 RMS volts-per-inch on narrow band. Horizontal amplifier .55 RMS volts-per-inch.

**Input Impedance:** Direct balanced, 6 megohms shunted by 11 uufd; unbalanced 3 megohms shunted by 22 uufd. Horizontal amplifier 1.5 megohms.

**Sweep Frequencies:** Saw tooth wave, 20

cycles to 50 kilocycles in 5 steps.

**Special Features:** All controls on front panel. Provision for 60 cycles or external sweep. Also has provision for grid modulation at 60 cycles or with external voltage. Full 5-inch CRT. Same height as new Jackson TVG-1 TV Sweep Generator. Rear terminal strips for direct connection, through capacitors, for A.C. voltages to CRT deflection plates. Light weight, easy to carry. Provided with leather carrying handle. Attractive all steel cabinet with gray Ham-R-Tex finish.

## JACKSON

**Service-Engineered  
Test Equipment**

remember—this Jackson oscilloscope supplies wide band width considered essential for TV sync. circuit testing.

Write for bulletin D-19 today.

**Jackson Electrical Instrument Company • Dayton 1, Ohio**



*Get  
EMERGENCY BAND  
CALLS At Home!*

• Many fans spend hundreds of happy hours listening to city and state police calls on their Polic-Alarm radios. . . . Polic-Alarm Model PR-31 is a quality radio which will give years of trouble-free service on the 30-50 mc. band. Can be used on either AC or DC current of 115 volts.

Besides police calls, the 30-50 mc. band also is used by fire departments, ambulances, border patrol, forestry, maritime, railroads, bus lines, and other services. Enjoy the thrill of listening to these vital messages at home. Model PR-31 (illustrated) **\$44.95**

Polic-Alarm Model PR-8 is available for 152-162 mc. band reception. **\$39.95**  
Price, complete . . . . .

# POLIC-ALARM

**RADIO APPARATUS CORPORATION**  
310 FOUNTAIN SQUARE THEATRE BLDG.  
INDIANAPOLIS 3, INDIANA

# RIDER BOOKS

Get **BETTER** and **BETTER** and **BETTER** and these **NEW** Books are our **BEST!**

They are in keeping with the high RIDER standards. They're "tops" in the field . . . containing more factual information, more practical data . . . more clearly presented than anywhere else.

**NOW AVAILABLE!**

## RADIO OPERATOR'S LICENSE Q AND A MANUAL

by Milton Kaufman

This book is a most complete and comprehensive treatment of the subject and should prove especially valuable as a quick review of essential theory, as well as a refresher for advancement in the field. It lists all the QUESTIONS and ANSWERS for the FCC examinations. However, the outstanding feature of this volume is its thorough FOLLOW-THROUGH—a carefully simplified discussion of the answer to the technical question . . . so necessary for a complete and absolute understanding of the answer. Useful appendices, which include Small Vessel Direction Finders and Automatic Alarm, not ordinarily available in a book of this type, provide a valuable "extra".  
608 pages, 193 explanatory diagrams. . . . \$6.00

## FM TRANSMISSION AND RECEPTION

by John F. Rider and Seymour D. Usian

Up-to-date • Basic • Complete

For the student who is grooming himself for activity in the electronic field. This book covers the subject of frequency modulation thoroughly in a down-to-earth treatment of all types of FM systems employed in television, radio, amateur radio, railroad, aviation, marine, police, point-to-point and mobile receivers. Basic theory, transmission, reception, circuit design and servicing are covered, with mathematics kept to an absolute minimum. Almost all presently used commercial FM transmitters are described in detail. Question section follows each chapter. 416 pages, profusely illustrated. . . . \$3.60

## INSIDE THE VACUUM TUBE

by John F. Rider

No other book explains so simply and clearly the theory of the vacuum tube and its operation. In plain language—with fascinating pictures and diagrams that really tell the story—you get a solid grounding in theory and a good working knowledge of basic tube types. It's concise, it's accurate.  
424 pages, profusely illustrated. . . . \$4.50

## UNDERSTANDING VECTORS AND PHASE IN RADIO

by John F. Rider and Seymour D. Usian

A Shorthand Method to Easier Understanding of Radio Theory Written for the student and for any man learning in radio and electronics who has not had the advantage of previous extensive mathematical education. Step by step, the subject is developed, until finally its application to everyday radio problems is demonstrated.  
160 pages, amply illustrated, cloth cover . . . \$1.89  
paper cover . . . . .99

## NEW . . . COMING SOON!

## THE THEORY AND PRACTICE OF 30-1000 MC RECEIVING ANTENNAS

by Arnold B. Bailey

This book is a rare combination of theory and practice that: 1.—Clearly explains and teaches. 2.—Can be used as a daily work reference.

An outstanding book, the like of which has never before been written. And since the author has resolved the mathematics of antenna problems into graphs, charts and tables—it can be put to good use by all. Reflecting world-wide knowledge of the antenna art, it clearly explains the theory behind the performance of every type of 30-1000 Mc receiving antenna on the commercial market, leaving the reader with a full understanding of why each behaves as it does. Practical in every sense of the word.  
More than 500 pages, 6" x 9", cloth bound. . . . \$4.50

## The New CATHODE-RAY TUBE AT WORK

by RIDER et al

The greatest and most complete reference book ever written on the cathode-ray tube! It is a practical, down-to-earth encyclopedia about five times the size of the old standard text. Starting with basic theory of cathode-ray tube operation, it proceeds through application in scopes and TV receivers—with full and clear explanations for uses in every field and research activity which employs a cathode-ray oscillograph. All scopes produced and sold during the last 10 years, more than 70 different models are described completely—with schematic wiring diagrams. Almost 500,000 words and about 3,000 illustrations are incorporated in more than 900 pages. It is a book which will enjoy years and years of daily use.  
22 chapters.  
8 1/2 x 11 inches. . . . \$9.00

## TELEVISION INSTALLATION TECHNIQUES

by Samuel L. Marshall

This book, written by Mr. Marshall, television instructor at the George Westinghouse Vocational High School, is a practical, easy-to-understand treatment of information pertaining to the antennas, transmission lines, receiver adjustments, and above all, the mechanical requirements, whether they be for short mast for chimney attachment or for the installation of a tower, including foundation. Both theoretical and practical aspects of every phase of this activity, from the topmost element of the antenna to the ground connection on the receiver terminal board, are fully discussed.

## VACUUM-TUBE VOLTMETERS

by John F. Rider

New • Revised • Enlarged

Now completely revised, enlarged, and thoroughly up-to-date, this volume explains theory and functions of the different types of vacuum-tube voltmeters. A special section is devoted to d-c and r-f probes and the concluding chapter discusses the latest commercial types of vacuum-tube voltmeters, complete with schematic diagrams.

**JOHN F. RIDER PUBLISHER, INC.**

480 CANAL ST., NEW YORK 13, N. Y.

## Calibration methods

Calibrating the frequency meter may present a problem. Usually its approximate frequency will be known from the size of the tank circuit. For example, an AR-5 coil tunes to about 38 mc when shunted by about 100  $\mu$ mf (refer to the manufacturer's chart). If its approximate frequency is still in doubt, proceed as follows:

Keep the calibrator tuning fixed and couple it to a nearby calibrated v.f.o. Tune the v.f.o. for two adjacent beats in the phones of the calibrator (disregard any very weak beats which may be heard). Assume readings of 3.5 and

note from the v.h.f. oscillator and simultaneously tune a low-frequency v.f.o. so that one of its harmonics creates a second beat. When the beats are heard simultaneously, the v.h.f. signal can be compared with the low-frequency source with an accuracy of a few parts in a million.

The calibrator unit is not limited to use in the citizens' band. It can measure frequency in any frequency range which is harmonically related to its fundamental. It could be used, for example, to locate and check most of the amateur bands.

The 710-ke modulation is not needed

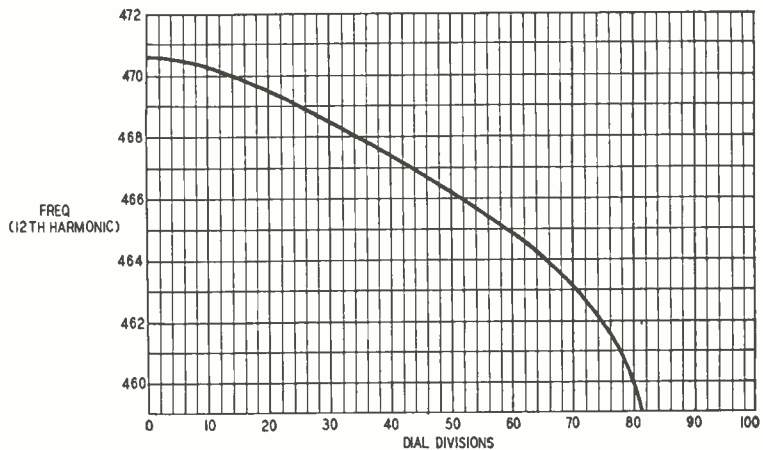

Fig. 3—Frequency chart showing coverage of the instrument. Accuracy at the edges of the band should be good enough to cover class A as well as class B stations.

3.85 mc. Subtract; divide the difference (0.35) into the smaller of the two (3.5). The answer is 10, which gives the harmonic order of the larger number (3.85). The calibrator is tuned to 38.5 mc which, of course, is the eleventh harmonic of the smaller number (3.5). Knowing the order of harmonic, a number of check points may then be obtained for the calibrator dial. Crystals may be used for highest precision.

The error due to the calibrator itself may be completely eliminated if desired. To do this, tune it to the rough

for most measurements. It can be led to a banana jack on the panel and thus be available for experimental measurements, as has been done here. A toggle switch in the filament circuit controls the modulator tube. The tube is switched on only when the low-frequency signal is needed.

With this unit, the experimenter should be able to make excellent frequency measurements on the 460-470 mc band whereas constructing a reliable oscillator for those frequencies might be well-nigh impossible.





**SIMPLE FILING SYSTEM**

Now that RADIO-ELECTRONICS has departments in its new format, it is easy to take out the articles you want to save and file them for future reference. Remove the staples from each issue so it will be easy to take out the pages. Staple each complete article together and file in an indexed folder. This arrangement saves space and makes it easy to find the information you are looking for.—*N. Schvedman*—

(Why not just file the whole issue, use a card index, and save work? The articles we want to refer to are always the ones we weren't interested in when they appeared, anyway.—*Editor*)

**POWERING SURPLUS RELAYS**

Surplus high-resistance relays have become fairly common as antenna-changeover relays, and in other low-power applications. However, it is difficult to obtain a suitable d.c. voltage to operate them.

One common type of relay suitable for low-power antenna switching has a resistance of 8,000 to 10,000 ohms and requires a "make" current of

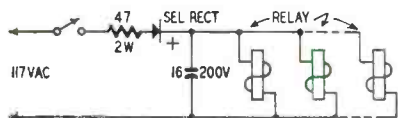

about 10 ma. The voltage may be obtained from a simple selenium rectifier circuit. Two advantages of this circuit are that the relay operation is independent of transmitter-receiver voltages, and that no warm-up time is required.

The hook-up is a half-wave rectifier having a single-section capacitor input filter. The relay windings act as both filter choke and load. The voltage developed across the relays is high enough to give good, positive action. No ground troubles are involved since the relay winding and terminals are isolated from each other. Five or six relays may be operated in parallel with a rectifier of suitable current rating before the voltage becomes too low for dependable action. A capacitor of the size shown or larger should be used to avoid any possibilities of chatter.—*Claire E. Shelden, Jr., WØHXN*



**THE TURNER GANG**

**WILL BE LOOKING FOR YOU  
ROOM 509A STEVENS HOTEL, MAY 22-25**

**THE TURNER COMPANY**

933 17th Street, N.E., Cedar Rapids, Iowa



**Microphones BY TURNER**

**2 FAMOUS ALMO T.V. ANTENNAS**

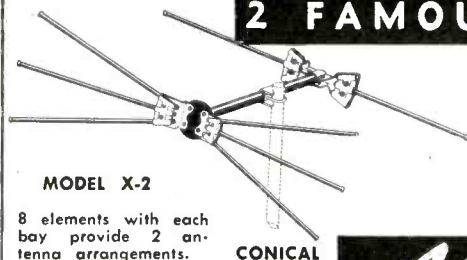

MODEL X-2

8 elements with each bay provide 2 antenna arrangements.

**\$3.95**  
Net

CONICAL

• Two of the most amazing performers yet to be used for television reception on the market. Maximum pickup, plus int. coupling gain characteristics. Order yours today. **RESULTS GUARANTEED**

10% CASH WITH ORDERS

—FOUR BIG STORES TO SERVE YOU—

**Almo**  
RADIO CO.

509 ARCH STREET, Philadelphia  
6205 MARKET STREET, West Phila.  
6th & ORANGE STREETS, Wilmington  
4401 VENTNOR AVE., Atlantic City

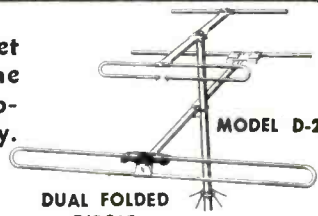

MODEL D-2

DUAL FOLDED  
DIPOLE

Folded dipole with reflector and matched Hi-band adapter.

**\$4.25**  
Net



## TELEVISION ANTENNAS

are required for the ultimate in FRINGE-AREA RECEPTION!

- \*6 ELEMENT SINGLE STACK Channels 2 to 6
- \*12 ELEMENT DOUBLE STACK Channels 2 to 6
- \*16 ELEMENT QUADRUPLE STACK Channels 7 to 13

MODELS  
23LD6  
456LD6

SINGLE STACK ARRAY  
8.3 db Forward Gain. Front to back ratio 32 db.

All WEPCO fringe-area antennas are supplied with fully telescoping elements adjustable for maximum gain on your favorite TV channel

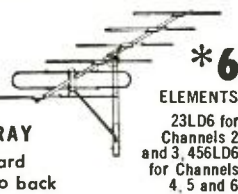

LIST PRICE \$42.50

MODELS 23LD12 & 456LD12

Provide two stacks of LD6 antennas with telescopic stacking Bars. LD12 series WEPCO antennas provide 14.1 db Gain. A necessity for 150 to 200 mile consistent reception. Order 23LD12 for Channels 2 & 3, 456LD12 for Channels 4, 5 and 6

MODEL 713LD16

especially designed for hi-channel fringe-area reception

- 18.9 db forward gain
- 27 db front to back ratio
- Telescopically adjustable elements providing maximum performance on your favorite TV channel

Order Model 713 LD16 LIST PRICE \$49.95  
Covers all channels from 7 to 13

### BROAD BAND TYPE V-88

An improvement on conical type antenna!

Offering:

- Full coverage channels 2 to 13 plus FM
- Double Stacking
- Superior Directivity
- Matches 75, 150 or 300 ohm line
- 6.2 db average gain over band

Order WEPCO Model V-88 LIST PRICE \$29.95



All WEPCO antenna designs are field tested for at least one year under nationwide weather, receiving and operating conditions before they are considered acceptable to the Company for manufacture. As a result, YOU are assured of superb performance, excellent durability under sleet and high wind velocity conditions.

## WEPCO ANTENNAS

May be ordered from your favorite Radio supply house or direct from

WALTER E. PEEK, INC., 2842 W. 30th St.  
INDIANAPOLIS 22, INDIANA

### POLARIZING LINE CORDS

Many a.c.-d.c. receivers and phono amplifiers are wired with one side of the line connected to the chassis. This presents a serious shock hazard when the user touches the chassis or other metal part if the ungrounded side of the line is connected to the chassis. Because most line plugs are not polarized, the user is never certain that the line cord will be plugged in correctly once it has been removed from its receptacle.

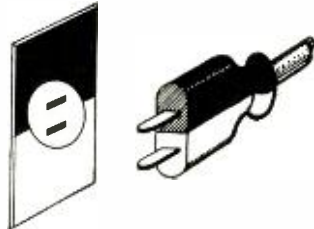

To avoid this trouble, plug in the set and turn it on. Take a small 117-volt lamp and connect one side to a radiator, cold water pipe, or outside ground wire; then touch the other lead to the chassis. If the lamp lights, the chassis is hot and the line plug must be reversed. When the correct polarity is found, apply a coat of paint to one half of the plug and to the corresponding half of the receptacle. The set will always be polarized correctly when the plug is inserted so its painted surface faces the painted surface on the receptacle.—Robert P. Balin

### IMPROVING TUNING EYES

To increase the sensitivity of 6E5's and similar electron-ray tuning indicators, insert a resistor R in the cathode circuit of the tube. When a negative voltage is applied to the grid, the triode plate current drops while the target current increases. The increase in tar-

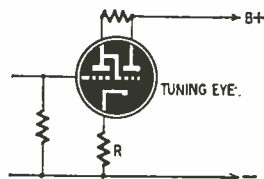

get current is much greater than the decrease in plate current so the total cathode current increases. The increase in cathode current through R biases the grid more negative, thus increasing the sensitivity of the tube and making the shadow angle smaller for a given grid voltage.

The value of R will probably be between 5,000 and 10,000 ohms, depending on the type of tube. The exact value should be determined by experiment. If R is too large, the tube may oscillate and limit its usefulness as an indicator.—D. Bosman

### EQUALIZER FOR V-R PICKUPS

It is not necessary to use the 6SC7 preamplifier-equalizer with variable-reluctance pickups when connecting them to conventional public-address amplifiers if you use the simple equalizer circuit shown.

The response with the equalizer is substantially flat. A slight bass boost can be had by replacing the .03- $\mu$ f capacitor with a .02- $\mu$ f unit. A slight high-frequency roll-off can be obtained by

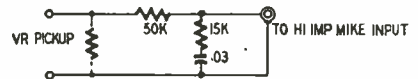

shunting the pickup with a resistance of 5,000 to 10,000 ohms.

The equalizer components should be placed in a shield can and connected to the amplifier and pickup through low-capacitance, shielded cable.—T. A. Hildebrand

### REPLACING RUBBER WASHERS

Many of the older receivers use rubber washers in friction-type dial mechanisms. When the rubber rots with age or deteriorates because of oil spilled on it, replacement washers are seldom available.

Being unable to obtain replacement washers for a dial drive, I made them by cutting circles (see drawing) from

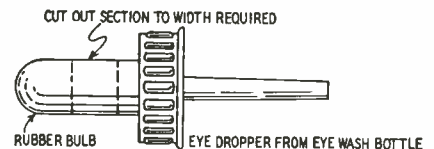

the bulb of a medicine dropper of the type which is built into the tops of eye-wash and nose-drop bottles. The rubber used in these droppers is of good quality, has fine grain and is of a convenient size.

If the washers do not fit snugly on the dial shaft, build up the shaft with layers of friction tape before slipping the washer on it. Clean the mechanism with carbon tet to make sure that there is no oily residue to contaminate the rubber.—J. A. Sabourin

### INDUCTANCE MEASUREMENTS

Multimeters having capacitance scales can be used to measure the inductance of small, low-resistance inductors. Adjust the meter to read capacitance in microfarads, place the inductor between the test leads, then record the meter reading. Measure the d.c. resistance of the inductor. The inductance in henries is found by solving the equation

$$L = \frac{\sqrt{X^2 - R^2}}{377}$$

where X is the 60-cycle reactance of the capacitance indicated on the meter, and R is the d.c. resistance of the inductor. The number 377 is  $2\pi$  times the frequency of 60 cycles.

For example, assume that a choke has a d.c. resistance of 50 ohms and the meter reads 8  $\mu$ f. Referring to a capacitive reactance chart, we find that the 60-cycle reactance of an 8- $\mu$ f capacitor is 340 ohms. Substituting in the equation,

$$L = \frac{\sqrt{340^2 - 50^2}}{377} = \frac{335}{377} = 0.83 \text{ henry.}$$

These calculations were carried out to slide-rule accuracy.—George McCullough

## TELE DEVICES

**American Phenolic Corporation**  
Chicago, Illinois

The American Phenolic Corporation announces two items of interest to television technicians and others working with high-frequency antennas.

A low-cost, compact, efficient lightning arrester, meeting all requirements for indoor and outdoor installation and bearing the Underwriters' Laboratories

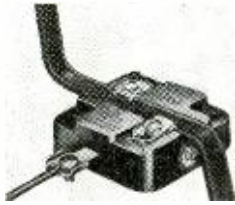

stamp of approval is a combination of the gap shunt-resistance types of arrester. It is easily installed under eaves, on a window sill, or on the wall; it can be used with all types of transmission lines but is primarily designed for use with 300-ohm, flat twin-lead. No stripping is necessary as toothed clamps on the arrester penetrate the insulation to make contact with the wires in the twin lead.

A new matching transformer, designed to avoid the mismatch and loss of signal which results from use of a folded dipole without matching to 72-ohm coaxial lead, employs Amphenol four-conductor twin-lead specially connected to provide a transformation in impedance from 300-ohms



down to 75. It is particularly useful in matching 300-ohm transmission line to 72- or 75-ohm input television receivers or providing an efficient match between any 300-ohm antenna and a coaxial 75-ohm line such as might be used in an area where the noise level is high.

This transformer is a key to the effective application of broadband antennas either to coaxial lead-in or to 72- or 75-ohm receivers. The terminals on the transformer are spade-type lugs at each end of the transformer section, which should be operated fully open or in a very loose coil. Tight coiling is unnecessary.

## PICKUP ARM

**Pickering & Co.**  
Oceanside, N. Y.

Features of the Pickering 190 arm include: a low-as-possible vertical-to-lateral moment of inertia; a minimized vertical mass in order to track any record without imposing extra vertical load on grooves so that badly warped records as well as flat ones can be played; absence of spurious arm resonance at any frequency; lower than 3-gram-centimeter pivot friction; rugged and trouble-free bearings; static balancing about the vertical axis to eliminate tendency to jump grooves when subjected to bumping or jarring; an offset head to reduce tracking error to less than  $\pm 2\frac{1}{2}$  degrees; and protection of stylus point.

In addition, the 190 arm includes adjustments for sensitive tracking force, height adjustment for turntables from  $\frac{1}{2}$  to 2 inches high, one-hole mounting



and self-contained leveling screws, plug-in cartridge holder, magnetic arm rest, and a completely visible stylus point for starting and cueing records.

## NEW CAPACITORS

**Centralab Division**  
**Globe-Union Inc.**  
Milwaukee, Wisc.

Formerly made in 20 values, the new Centralab BC Hi-Kap capacitors now come in 48 different values and four sizes, with tolerances of 20% from 10 through 2,200  $\mu\text{f}$ , and guaranteed minimum values from 2,500 through 10,000  $\mu\text{f}$ .

The BC Hi-Kap capacitors have a low power factor, are designed to withstand high temperatures, and are moisture-proof. The capacitors have No. 22 tinned soft copper wire radial

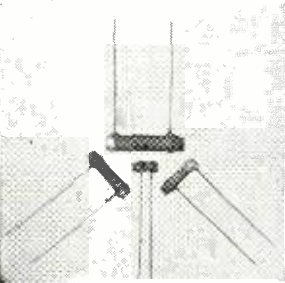

leads to permit easy, close-coupled connections.

The BC Hi-Kaps are used as replacement capacitors in TV, AM, and FM receivers, and supplant the old-style tubular capacitors in much new equipment.

## PARABOLIC ANTENNAS

**Workshop Associates**  
Newton Highlands, Mass.

Five new parabolic antennas to cover the frequency band from 5,925-7,125 mc are now available. These models, together with previously announced models for 940 and 2,000 mc, comprise a complete line of parabolic antennas for commercial frequency allocations.

Each parabola is available in 2-, 4-, 6-, and 8-foot diameters, and mounts are available for all types of installations. The antennas have gains up to 44.9 db, and can be supplied with complete de-coding equipment and junction boxes.



## C-R OSCILLOSCOPE

**Allen B. Du Mont Labs, Inc.**  
Clifton, N. J.

The type 250-AH scope employs a DuMont type 5RP-A high-voltage cathode-ray tube. The over-all accelerating potential for this tube, supplied by an external high-voltage power supply, is 13,500 volts. This high potential makes possible the observation and photographing of high-speed signals.

In the type 250-AH, as in the earlier type 250-H, input signals may be applied through an a.c. amplifier, through a d.c. amplifier, or directly to the deflection plates for both X- and Y- axes. The frequency response of the d.c. amplifiers is uniform within 10% to 200,000 cycles, while the response of the a.c. amplifiers is uniform within 10% from 5 to 200,000 cycles.

The type 250-A, a low-voltage version of the type 250-AH, is also available. It employs a type 5CP-A cathode-ray tube operated at an over-all accelerating potential of 3,000 volts.

A built-in square-wave voltage calibrator, accurate to within  $\pm 5\%$ , provides outputs of 0.01, 0.1, 1.0, 10, and 100 volts.

## AUDIO CONNECTORS

**Cannon Electric Co.**  
Los Angeles, Calif.

The UA series by Cannon Electric consists of present of two plugs and four receptacles, carrying three 15-amp contacts rated at 1,500 volts minimum flashover.

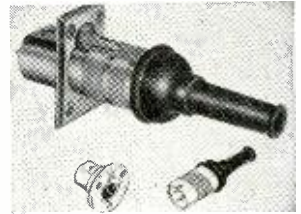

UA plug shells are steel; receptacles zinc. Both are finished in satin chrome. The flattened plug top provides better polarization means than ordinary keyways, having a finger touch design. The safety latchlock device is improved and strengthened; socket contacts are full-floating. All contacts are gold-plated for long life. Cable entry is  $\frac{1}{2}$ -inch. Insulators are all-purpose Durez; inserts may be removed without screws by pressure on a spring release button. Rubber bushings and cable relief collar protect the connectors from shock and moisture.

## PA SPEAKERS

**Racon Electric Co.**  
New York, N. Y.

The COB speakers are designed to cope with the problem of large noisy crowds and to supply a uniform field over a horizontal angle of 120 and

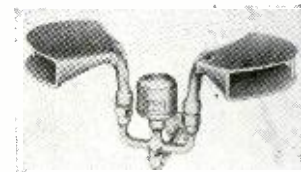

vertical angle of 40 degrees, thus concentrating and beaming the sound for maximum efficiency. Cutoff point is 370 cycles to produce crisp, articulate speech, thus simplifying amplifier requirements considerably.

Additional specifications for the COB-2 back-to-back combination: 25 watts operating capacity; 50 watts peak capacity; response 370-6,500 cycles; impedance 15 ohms; sensitivity as bidirectional speaker is 105 db at 4 feet, 1 watt input; sensitivity as single wide-angle speaker is 108 db at 4 feet, 1 watt input.

# RADIOMEN'S HEADQUARTERS \* WORLD WIDE MAIL ORDER SERVICE !!



## ACRO TELEVISION CHASSIS CRADLE

Pays for itself in a week—Saves and eliminates broken tubes, coils, dials, etc. Cadmium plated steel, finger-tip control. A necessity for Television Service. Your Cost ..... \$4.69

**RT1655**  
Only \$14.95



11 tube crystal controlled superheterodyne receiver that covers the FM band. The ultra modern circuit uses the latest types of tubes including 7 miniature 6AJ5's. Beautiful chassis and aluminum cabinet. Tubes and diaphragm included.

Universal 4 lead broadcast band oscillator coil (can be converted to 3 lead type by addition of jumper). **75¢** for \$1.00



## SIGNAL GENERATOR

Genuine Laboratory-type precision signal generator. Manufactured and sold for \$68.00 each in large quantities during the war by Northeastern Engineering Corp., one of the top manufacturers of electronic equipment for the U.S. Govt. Five fundamental bands starting at 150 KC. Strong harmonics up to 120 Mc. Five step ladder type attenuator as well as potentiometer output control. Regular 1000 cycle audio oscillator using vacuum tube, not a cheap neon sawtooth audio oscillator. Audio output separately available externally. Weight without packing material 16 lbs. which should show what a world of difference exists between this signal generator and the ordinary cheap oscillator used by the average serviceman. Complete with fused plug and coaxial output lead. Super Special \$38.75.



## POWER RHEOSTAT

Exceptionally Rugged. Trouble-free design. Withstands severe overloading to many times the nominal 25 watt rating without burning or smoking. Perfect for motor speed control or line voltage adjustment. 3 sizes available: 50, 60 and 200 ohms. Regular price \$5.20. Special—\$1.00.



## SCR-274N COMMAND SETS

(Made by Western Electric for U. S. Gov't)  
**THE GREATEST RADIO VALUE IN HISTORY!!**

A mountain of valuable equipment that includes not 1 but 3 of the hottest superhet Communications Receivers, each of which has a tuned R.F. stage, 3 gang condenser, crystal, and 6 working tubes not counting rectifiers. Also included are 2 Tuning Control boxes, 1 Antenna Coupling Box with R.F. meter to measure power fed into antenna; four 28V Dynamotors (alteration of set to 110V operation is quick and simple); two 40 Watt Transmitters including crystals; and Pre-Amplifier and Modulator so that transmitters can be used for voice as well as code. 29 Tubes supplied in all. In guaranteed electrical condition. Transmitters and Receivers instantly removable from mounting racks which hold them in position in aircraft use, so that they can be used separately at different locations just like any other sets. Only a limited quantity available, so get your order in fast. A super value at \$59.95.

**LINE FILTERS**—Each unit contains two 4 Mfd. oil filled condensers and a high inductance 50 Amp choke in fully shielded enclosure. Suitable heavy current connectors are provided to attach to the input and output connectors at each end of the filter from your input and output wires. A filter with innumerable uses on oil burners, refrigerators, boats, automobiles and wherever noise is to be suppressed or interference abolished. A \$17.00 value for \$1.98.

## SNIFFIN' FOR



## BARGAINS?

Highest quality telescoping folded dipole rooftop type antenna with all the features usually expected in such an antenna, including use as dipole and reflector, and in addition a mounting bracket provided so that the antenna can be installed in any window in two minutes or less. Any slight loss in gain because of the reduction from rooftop height is more than compensated by the ability to orient the antenna instantly by opening the window and adjusting for maximum signal strength. Mounting bar can be installed horizontally or vertically in window frame or even between attic rafters, whichever is most convenient. Your cost \$8.65. With high frequency attachment for channels 7 to 13 \$11.00. Either type 10% less in dozen lots.

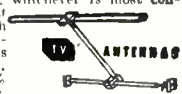

**BUFFALO RADIO SUPPLY, 219-221 Genesee St., Dept. RE-1 BUFFALO 3, N. Y.**

“I can't understand why your picture is so much better than ours! It's the same make of set, you know!”

“Well, according to the TV service man, the picture quality of any TV set is only as good as the antenna on the roof. We have an Amphenol **INLINE** Antenna and that accounts for the better picture quality.”

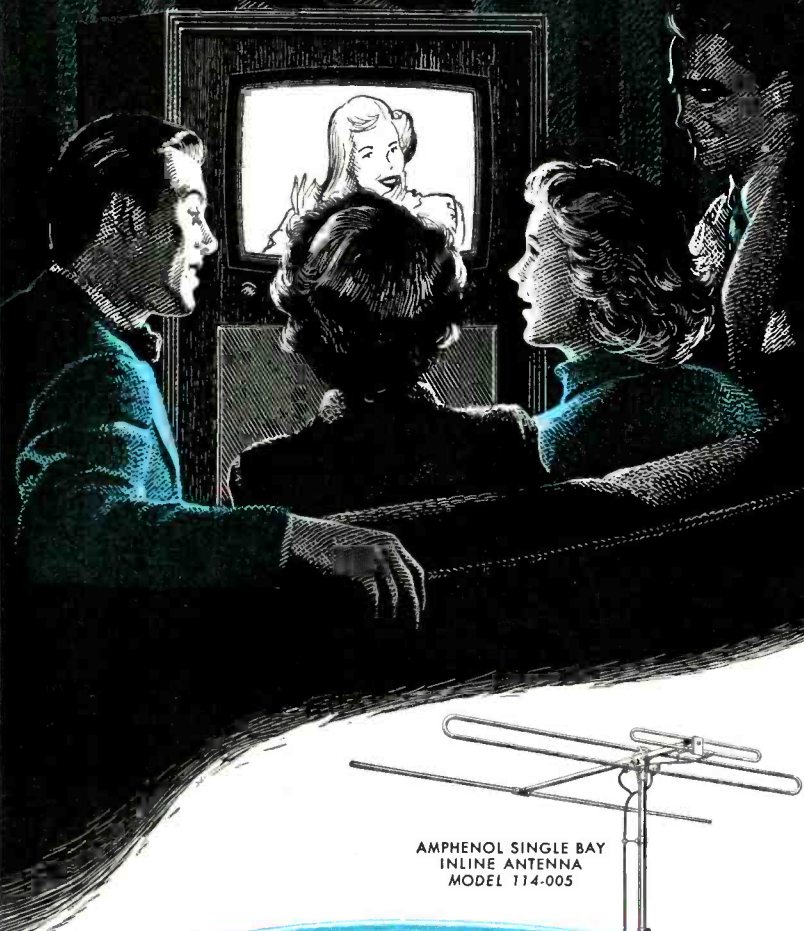

AMPHENOL SINGLE BAY  
INLINE ANTENNA  
MODEL 114-005

**AMPHENOL**

AMPHENOL



TV ANTENNAS

\*U. S. Patent No. 2,474,480



**AMERICAN PHENOLIC CORPORATION**  
1830 SO. 54TH AVENUE • CHICAGO 50, ILLINOIS

## New Devices

### TWIN-DRIVEN YAGI

Technical Appliance Corp.  
Sherburne, N. Y.

A new twin-driven Yagi, No. 985—4½, has performance peaks at both channel 4 and channel 5.

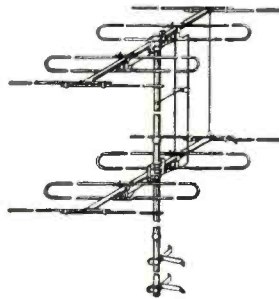

With this new design it will now be possible to achieve the gain in the antenna heretofore possible on only one channel. In fringe areas or weak signal locations it will bring in signals and at the same time not require the most height required for comparable signals by other antenna types.

### TWO TUBE TESTERS

Sylvania Electric Co.  
New York, N. Y.

Features of Sylvania's new testers for portable and bench use include an ohmmeter-type shorts and leakage test, which indicates "Replace" or "Good" directly on the instrument's illuminated meter; direct meter indication for all other tests; an easy-to-operate gas test; and a combined emission and trans conductance test under dynamic



operating conditions, which takes relative tube life into account. Twelve sockets provide for testing four-, five-, six-, seven-, eight-, and nine-pin tubes; octal and lock-in miniatures; sub-miniature, acorn, and hearing-aid types; mobile and ruggedized tubes; and pilot lamps.

Facilities for unannounced types are included. Control settings are shown on a roller chart which is easily removable from the front panel for adding new tube settings.

### RADIO KITS

Meissner Mfg. Division  
Maguire Industries Ltd.  
Mt. Carmel, Ill.

Meissner announces the addition of five new radio kits to their line (which includes the Signal Shifter kit, broadcast and shortwave kit, and others).

Typical of the kits in this new group is the T8CK, the Meissner FM receptor in easy-to-build kit form. The T4AK is a 20-watt power amplifier kit that can be quickly assembled into a professional looking piece of equipment.

The T2BK 2-tube battery trainer kit and the T3BK a.c.-d.c. trainer kit furnish beginners with instruction and low-cost radio sets. The T6BK 6-tube a.c. superhet kit affords instruction in more advanced receiver design.

### IMPROVED PICKUPS

The Astatic Corporation  
Conneaut, Ohio

The new units of the AC series have housings of molded Bakelite and metal mounting brackets (which fit standard ½-inch mounting centers) and needle guards. The cartridges use Astatic's

special type C Taper-Lock needle, which features ease of changeability without tools.

There are four models in the AC series. Model AC-78 has a 3-mil-radius stylus tip, either precious metal or sapphire, for standard 78 r.p.m. records; model AC, a 1-mil stylus for narrow-groove, slow-speed records; model AC-AG has Astatic's new All-Groove stylus tip, of special design to play 33-1/3, 45, and 78 r.p.m. records; and model ACD is a turnover cartridge with dual needles to play narrow-

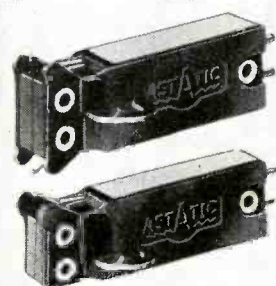

groove records on one side and 78 r.p.m. on the other.

The frequency range of all models is from 50 to 10,000 cycles. Needle pressure of the AC model is 5 grams, while that of the others is 6 grams. Output of all, at approximately 1,000 cycles, is 1 volt, using the Audiotone 78-1 and RCA 125-3IV test records.

### LOUD SPEAKERS

University Loudspeakers Inc.  
White Plains, N. Y.

Two complete reflex trumpet speakers with an integral 30-watt driver unit and built-in multitap line matching transformer are announced. Model 7101 is UL approved for class I, groups C and D, which include locations in which flammable, volatile liquids, highly flammable gases, mixtures or other flammable substances are manufactured, used, handled, or stored. Model 7102 is approved for both class I as well as class II, groups E, F, and G, which include those locations in which combustible dust is thrown or suspended in air, producing explosive mixtures, and in places where such dust may collect or settle on motors, lamps, or other electrical devices.

Specifications for both models are as follows: maximum power input, 30 watts; frequency response, 200-10,000 cycles; impedances, 16,500, 1,000, 1,500, 2,000 ohms. The dimensions are: length—19 inches; height—16 inches, and the



mounting is a swivel U bracket with adapter for ½-inch pipe mounting available. Cable entrance is tapped for standard ½-inch conduit, and the net weight is 20½ lbs.

### GEIGER COUNTER

Precision Radiation Instruments,  
Inc.

Los Angeles, Calif.

This instrument has been designed particularly for the prospector.

It detects beta, gamma, cosmic, and X-rays. It includes an earphone as well as a neon flasher and a 3-range meter as indicating means. It is completely tropicalized and weather-proofed. Its 900-volt Geiger tube with a 30-milligram-per-square-centimeter thin window section has a life in excess of 100 million counts. A stainless steel probe is available as optional equipment, although the entire instrument is small enough to be used as a probe.

RADIO-ELECTRONICS for

It has an electronic automatic voltage regulator to keep the high voltage constant.



The specifications are: Size: approximately 3 1/2 x 4 x 6 1/2 inches. Weight: approximately 3 1/2 lbs. Ranges: 20, 2, and 0.2 milliroentgens per hour. Sensitivity: beta and gamma.

**8-WATT AMPLIFIER**

Minnesota Electronics Corp.  
St. Paul, Minn.

This amplifier is an 8-watt unit designed for the inexpensive home installation in which an amplifier is needed for radio, phonograph, and television. Specifications are:

Bass control: Continuously variable. Variation available ± 16 decibels at 40 cycles. Initial boost starts at very low frequencies.

Treble control: Continuously variable. Variation available ± 16 decibels at 10,000 cycles.



Stabilized degenerative feedback: Circuit reduces internal generator impedance to approximately half of speaker impedance.

Output impedances: Selector switch provides choice of 4-8-20-250-500 ohms ganged to simultaneous switching of feedback resistors for optimum performance on each tap.

Inputs: Four-position switch provides radio-78-r.p.m. phono-LP phono-television with automatic equalization inserted for LP and 45-r.p.m. records. Socket provided with power supply for plug-in phono preamplifier.

Frequency response: 20 to beyond 20,000 cycles within 1.5 decibels.

Power output: Conservative rating 8 watts.

Hum level: More than 60 decibels below rated output.

Oscillation: No tendency to oscillate under any load conditions.

Intermodulation distortion: Less than 5% at rated output.

Harmonic distortion: Less than 2% at rated output.

Tubes: 2-6L6, 1-5U4G, 1-6SN7 (dual), 1-12AX7 (dual).

**TEST EQUIPMENT**

Precision Apparatus Co., Inc.  
Elmhurst, N. Y.

A complete basic AM-FM-TV testing and service laboratory, consisting of a set of five matched instruments, is announced.

This combination comprises the complete working facilities for a service technician and is available in various models and styles to suit individual applications in shop or field uses.

It also permits servicemen to round out incompletely equipped labs with additional units which will match the ones they already own.

The equipment consists of: marker-signal generator, sweep signal generator, cathode-ray oscillograph, v.t.v.m.-megohmmeter, and tube tester.

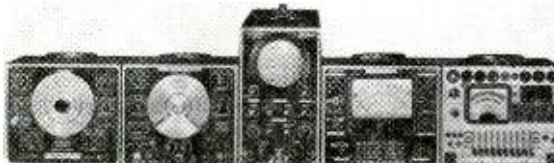

**PHONO MOTOR**  
General Industries Co.  
Elmyria, Ohio

This turret-type phonomotor for use in three-speed record changers has turntable speeds of 33 1/2, 45, and 78 r.p.m., secured through three separate pulleys mounted on a turret plate. With a simple lever, the desired pulley is brought into contact with the idler wheel.

The entire mechanism is powered with a dynamically balanced two-pole,

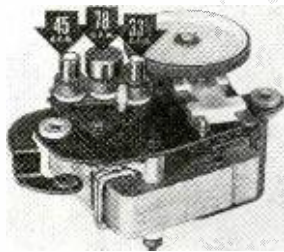

shaded-pole motor. Symmetrical electrical and mechanical design results in minimum stray field and maximum performance for physical size.

**HY-SON TWEETER**

Stephens Manufacturing Corp.  
Culver City, Calif.

The Hy-Son high-frequency reproducer is designed for the 3,500-20,000 cycle range. Specifications are:

Power input above 3,500 c.p.s., 20 watts from program material, 5 watts steady tone. Reproducing range 3,500-20,000 cycles, flat ± 3db to 15,000 c.p.s. Impedance, 16 ohms. Voice coil diameter 1 inch, motor mass 350 milligrams. Weight, unit, and crossover combined, 5 1/2 lbs. Size, driver only, 3 1/2 inches diameter by 2 1/2 inches deep, with 2 x 4, 40° x 80° high frequency horn attached, 7 inches deep overall.

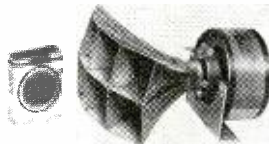

**TAPE RECORDER**

Berlant Associates  
Los Angeles, Calif.

The Concertone is a high-fidelity magnetic tape recorder designed for custom installation in studios, schools, homes, and industrial plants.



The basic recorder No. 401 complies with NAB standards. Among its features are instantaneous monitoring from the tape while recording, separate heads for high-frequency erase, record and playback, forward and reverse high-speed rewind, three dynamically balanced motors, record level indicator, instantaneous choice of 7.5- or 15-inch-per-second tape speed, independent azimuth adjustment for each head, and either standard 7-inch or NAB 10 1/2-inch reels. It is quickly convertible to either a console or portable unit.

**TWIN-TRAX\* TAPE RECORDERS**

*feature*

- WIDER FREQUENCY RESPONSE
- GREATER DYNAMIC RANGE
- LONGER PLAYING TIME
- - - - - and lower price!



For the Home \$285



Broadcast Studio \$375



Educational Institution \$335



Wired Music System \$495



Experimenter \$89.50

**AMPLIFIER CORP. OF AMERICA**

**SAVE**

THAT GOOD LOOKING OLD CONSOLE  
WITH THE OBSOLETE RADIO!

*install a modern*

**ESPEY AM/FM CHASSIS**

and your favorite console is "right-up-to-date"



Rated an excellent instrument by America's foremost electronic engineers. Fully licensed under RCA patents. The photo shows the Espey Model 511, supplied ready to play. Equipped with tubes, antenna, speaker and all necessary hardware for mounting.

**ATTENTION SERVICEMEN**—Did you know there are over 19 million consoles waiting to have a modern AM/FM chassis installed? Here is a gigantic sales market just waiting for you to develop. In fact there are thousands of out-moded radios in your "backyard" just waiting to be replaced.

Visit our Booth 406 at the Parts Show

Makers of fine radios since 1928.

Write for literature RC for complete specifications on Model 511 and others.

**ESPEY**  
MANUFACTURING COMPANY, INC.  
528 EAST 72nd STREET, NEW YORK 21, N. Y.

# INSTRUMENT KITS

THE NEW MERIT LINE OF

by RCP

NOW you can get in KIT FORM the best professional test equipment made by RCP—one of the outstanding manufacturers of test instruments for 18 years. Thousands and thousands of RCP testers are in use — giving satisfaction for years.

## EASY TO BUILD!

Each Kit contains simple step by step illustrated instructions — clear wiring diagrams — assembly diagrams — multi-colored stranded wires for easy checking and trouble shooting — easiest to follow.

### MERIT MODEL 345K SUPER VACUUM TUBE VOLTMETER

Features long scale 4 1/2" meter in burn out proof meter circuit — electronic balanced bridge type push pull circuit—negligible current drawn due to high input impedance of 25 megohms — Isolation Probe — center of ohm scale 10 ohms — 5 ohmmeter ranges reading from 2 ohms to 1 billion ohms (1000 megohms). 20 voltage ranges 0-1000 volts including AC and DC — Complete D.B. meter.

Discriminator alignment scale with zero center permitting operation in both directions. Operates on 105-130 volts, 50-60 cycles—Extra heavy panel, case and chassis. Size 10" x 6" x 5". Weight 8 3/4 lbs. Shipping weight 11 lbs.



**\$23.95**

MODEL 345K KIT COMPLETE.....  
Complete factory built and wired..... **\$49.95**

Super High Voltage Model HV345K — includes high voltage multiplier probe and has extra DC voltage ranges — 0-5-25-100-250-500-1000-2500-10,000-25,000 volts with certified safety probe.  
Complete Kit ..... **\$27.95**  
Factory built and wired complete..... **\$57.95**

Super Model HVHF345K both High Voltage Multiplier Probe and High Frequency Probe which extends the frequency range of the 345K to 400 megacycles. This covers a complete Television and Citizens band.  
Complete Kit HVHF345K..... **\$31.25**  
Complete factory built and wired... **\$64.95**

### MODEL 777A DYNATRACER



New Model Signal Tracer—Ultra Modern—Circuit design provides exceptionally high amplification so that actual gain measurements may be made. Accurate meter gives calibrated indications. Provides the speediest type of trouble shooting tool for tracing any type of disturbance or circuit defect from the antenna to the speaker. Indicates noise pickup at the aerial—checks AVC—AFC, link and filter circuits.

You get readings of signal strength and actually hear the signal and any variation or distortion at any point in the circuit. Permits you to follow through from the antenna through each stage of r-f—i-f—a-f step by step without operating any switches. Negligible outside pickup of noise and hum—negligible disturbance to circuit under test as the input capacity is only 3 micromicrofarads. Attenuation is 10,000 to 1 by means of a ladder attenuator with vernier control. Sensitivity is 10,000 microvolts for full scale deflection of meter or 200 microvolts per division. Frequency range approximately 160 megacycles. Jack provided for testing microphones and pickups. Automatic control switch permits either speaker or meter to be used alone or together or standby.

Tube Complement 6AU6 — 6AT6 — 6AQ5 and 6X4. Crystal Rectifier 1N34. Speaker employs Alnico 5 magnet. Beautiful hammer-tone grey steel panel and case with new spherulized probe. Kit supplied complete. 105-130 volts, 50-60 cycles. Size 6 5/8" x 3 3/4" x 11". Weight 9 1/2 lbs.

**\$31.95**

MODEL 777AK.....  
MODEL 777A—Complete factory built..... **\$41.50**

### HIGH VOLTAGE MULTIPLIER KIT MODEL HVMP-1K



Permits multiplying all ranges X100 of Model 345 or any other similar impedance V.T. voltmeters — special ceramic helical high voltage resistor certified safe for all ranges up to 33,000 volts.

Complete Kit ..... **\$5.95**  
HVMP-1—Complete factory built ..... **\$7.95**

### ULTRA HIGH FREQUENCY PROBE KIT MODEL HFP-1K



Uses germanium crystal with low impedance network permitting measurements up to 400 megacycles.

The finest in performance and appearance.  
Complete Kit..... **\$3.65**  
HFP-1—Complete factory built..... **\$6.95**

Buy them from your jobber, or, if he cannot supply you, write factory direct. Accept no substitute. See these units on display at the Radio Parts & Electronic Equipment Show Chicago — May 22-25 — Stevens Hotel — Booth 416 or Display Room 556A

Write for Catalog 5 RE

**RADIO CITY PRODUCTS CO., INC.**

152 WEST 25th ST — NEW YORK 1, N. Y.



## VOLUME COMPRESSOR

Patent No. 2,492,707  
John C. O'Brien, Rochester, N. Y.  
(Assigned to Gen. Railway Signal Co.)

This communication system has facilities for 2 microphone inputs. One is volume-controlled for use by trainmen in noisy locations. Different speech levels give practically constant output. Loud speech reduces the background noise because of the volume limiter. The second microphone input is not controlled.

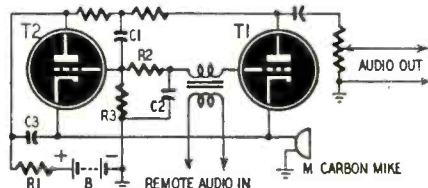

The controlled microphone of the carbon-button type is connected in the cathode circuit of two tubes. T1 is the amplifier and T2 is the control tube. With loud speech input, a high a.f. voltage is fed from the T1 plate to the T2 grid. This is rectified by the grid and appears across R3 as added negative bias on both tubes; therefore, total cathode current is reduced. This cuts the button current and consequently the sensitivity of the microphone so that the output tends to remain constant regardless of speech level.

R2-C2 filters the audio to prevent feedback to the grid of T1. R1-C3 keeps a.f. out of the common B-supply.

## AUTOMATIC RAILWAY SIGNALING

Patent No. 2,492,388  
Paul N. Martin, Penn Township, Pa.  
(Assigned to Union Switch & Signal Co.)

This circuit has special importance in detecting the presence of railway cars on a stretch of track. Other methods often depend upon current flow through rails, but when rails are seldom used, their resistance is apt to become very high. In this case the capacitance of a car operates the circuit.

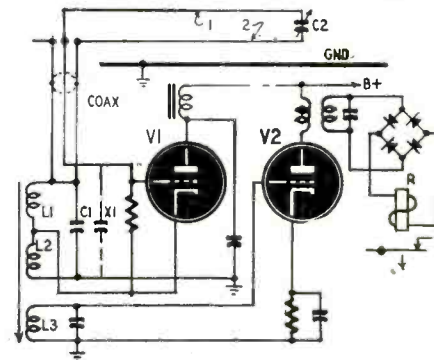

### Car capacitance operates the circuit.

V1 is a low-frequency Hartley oscillator with tank circuit L1, L2, and C1. The upper end of L1 is connected to the grid through C2. Insulated lines 1 and 2 may be suspended alongside the rails as in (a) or they may be in the form of additional rails as in (b). In either case the capacitance between line 1 and ground is normally small. Note that conductor 2 acts as a shield for 1 over the distance between the tank circuit and the section of track. C2 is adjusted to prevent oscillations.

When a car is moved onto the tracks adjacent to the lines 1 and 2 (dotted figures), appreciable capacitance is shunted across C2 and oscillations start. These are transferred to L3 and amplified by V2. The a.c. is rectified for energizing relay R. The relay contacts may be used to throw a rail switch, turn on a danger signal, etc., to prevent the movement of another car onto the same siding.

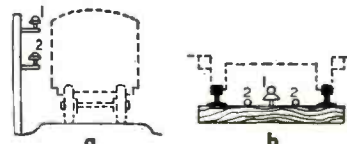

### Alternate ways of running the lines.

RADIO-ELECTRONICS for

IN THE SETS OF THE BEST MANUFACTURERS FOR YEARS...

**NOW!**

it's **TEL-O-TUBE** for **REPLACEMENT!**

**PRODUCTION 1800 PER DAY!**  
**IMMEDIATE DELIVERY ON ALL TYPES!**  
**PROVED SUPERIORITY!**

For manufacturers, Tel-O-Tube has long meant higher picture tube quality at lower cost. The list of famous TV set makers who have specified Tel-O-Tubes for their production is a virtual who's who of the industry—Admiral, Ansley, Crosley, Emerson, Garod, Olympic, Starret, Tele-King, Tele-Tone, Sightmaster, Video Corporation of America, etc. Again and again, Tel-O-Tubes meet the critical approval of these receiver manufacturers. Here is indisputable proof of Tel-O-Tube superiority!

Now Tel-O-Tube means more replacement sales at lower costs for more profits for you. We have stepped up our production to a new high of 1800 a day, and are pushing higher every week—to fill your replacement needs for the finest picture tubes of every type—with immediate delivery!

Tel-O-Tubes are made in our 3 new modern plants under the newest, most stringent quality controls and test tolerances, backed by the latest engineering "know-how." That's why you get more dependable performance and longer life—more sales and more profits—with Tel-O-Tubes.



**New Tel-O-Tube 16XP4 16" Rectangular**

Take a tip from the quality-conscious receiver manufacturers—specify Tel-O-Tube. We have a "honey" of a sales story for every TV serviceman interested in profits in picture tubes. For full details, write NOW to Dept. E-1.

**TEL-O-TUBE SALES CORPORATION**

469 SEVENTH AVENUE, NEW YORK 18, N. Y.

Telephone: Pennsylvania 6-7385-6-7

**OSCILLOSCOPE SWEEP**

Patent No. 2,489,312

Humbert P. Pacini, Utica, N. Y.

(Assigned to the United States of America as represented by the Sec'y of War)

For precise oscilloscope measurements an accurate sawtooth sweep must be used. The rising portion must be linear and the retrace must be rapid. Both requirements are met with this two-tube circuit. A square wave generator controls the charge and discharge of a capacitor.

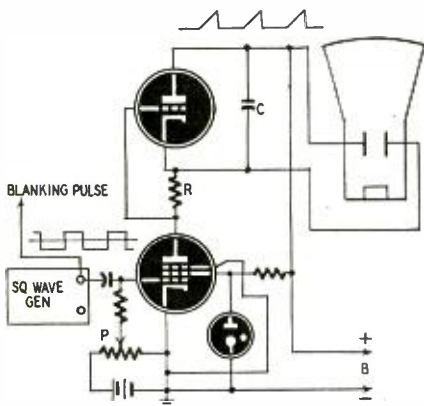

The pentode is biased below cutoff to conduct only when the square wave input exceeds its bias. The plate current of a pentode remains constant regardless of plate voltage. The screen voltage exercising considerable control over  $I_p$ , a VR tube is used to keep this voltage fixed.

When the square wave is positive, the pentode conducts and the constant  $I_p$  flows through R and C. A voltage drop then exists across the resistor and this biases the triode to cutoff. C charges at a linear rate. When the square wave polarity changes, pentode current stops and the bias across R disappears. The triode conducts and discharges C quickly. The next sawtooth wave begins when

the square wave swings positive again. The sweep voltage appears across C.

The potentiometer P controls the bias on the pentode and therefore determines the height of the sawtooth (sweep amplitude). Less bias means more plate current and therefore a greater sawtooth voltage. The width and frequency of the sawtooth wave equal that of the square wave generator.

A lead from the square wave generator may be connected to the oscilloscope to blank the pattern during retrace.

**MERCURY-CONTROLLED OSCILLATOR**

Patent No. 2,491,486

Harold I. Ewen, U.S. Navy

(May be used by the U.S. Government without payment of royalties)

Mercury is a conductor of electricity and therefore affects the magnetic field of a coil. If a mercury thermometer is placed within an oscillator tank coil, the frequency depends upon the height of the mercury column.

As a typical application of this invention, small changes of temperature may be indicated by noting the frequency of an oscillator (which has been previously calibrated in terms of degrees).

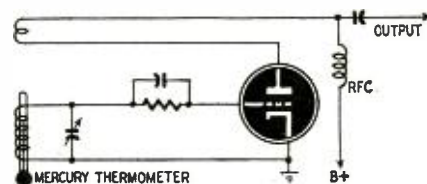

**MAGNETIC DETECTOR**

Patent No. 2,477,337

William E. Kahl, West New York, N. J.

(Assigned to Bell Tel. Labs, Inc.)

This invention relates to magnetic detectors such as the one illustrated here. The a.c. source is

filtered to supply a pure sine current to the magnetometer coil L. Because of saturation, the flux around L and the induced voltage across it becomes distorted. Although the induced voltage is distorted, it remains symmetrical because the exciting current is symmetrical. A symmetrical voltage wave has no even harmonics.

In the presence of an external, unidirectional flux, the field near L is no longer symmetrical. The external flux adds to the coil flux during one half cycle and subtracts from it during the other half. Therefore, the induced voltage across L is asymmetrical and contains even harmonics. The strength of the external field is indicated by the magnitude of the even harmonics, preferably the

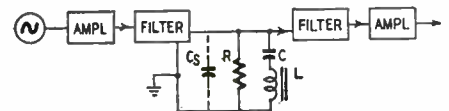

second. The output filter passes only second harmonics to be measured or recorded.

This inventor has discovered that, when L is tuned to series resonance (by capacitor C), the magnetometer is less critical to changes in exciting current or distributed capacitance  $C_s$  between leads. A resistor R also improves the performance.

**MINE COMMUNICATIONS**

Patent No. 2,499,195

James A. McNiven, New York, N. Y.

In mine emergencies, such as cave-ins, explosions or fires, miners may be imprisoned in isolated tunnels. Rescue operations could be carried on more efficiently and with a greater chance of success if the miners below could communicate with the rescuers and direct their operations.

This invention describes a frequency-modulation communications system operating on frequencies between 80 and 150 kc. The antenna system consists of probes driven into the roof or sides of the tunnel, as far apart as may be feasible.

The equipment is so designed that it may be operated with power obtained from miners' lamp batteries or a hand-cranked generator.

## SERVICEMEN! We'll Prove You'll Save Time & Earn More with PHOTOFACT!

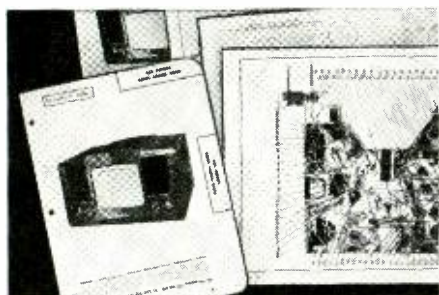

We'll send you absolutely

# FREE

any PHOTOFACT Folder  
listed in the Photofact Cumulative Index

NOW—learn for yourself—at our expense—how PHOTOFACT makes your service work quicker, easier, more profitable! Examine an actual PHOTOFACT Folder. Use it. You'll learn first-hand why this indispensable service data is used daily by over 35,000 successful service technicians. You'll discover quickly that no other service gives you PHOTOFACT's outstanding advantages: *completeness, accuracy, uniformity and ease-of-use* at the lowest cost to you! PHOTOFACT alone is the only radio service data prepared from laboratory analysis of the actual equipment. Nothing in the field equals PHOTOFACT. Know the facts—get your FREE Folder now. Examine it—use it—compare it—learn why no modern service shop can afford to be without PHOTOFACT!

**NOTE:** This FREE offer is limited to Service Technicians. Attach coupon below to your letterhead and mention the name of your jobber. If you have no letterhead, send coupon to your jobber. Experimenters and others may obtain the Photofact Folder by remitting amount shown below.

HOWARD W. SAMS & CO., INC.  
2201 E. 46th St., Indianapolis 5, Ind.

- Send FREE Photofact Cumulative Index
- Send Full Easy-Pay Details

I am a Service Technician:

- Send FREE Folder for set model. . . . .

I am an Experimenter: Enclosed \$ . . . . .

- Send Folder for set model. . . . .

TV—\$1.00; Record Changer or Comm. Receiver—75c; AM/FM—50c

Name.....

Address.....

City.....Zone.....State.....

### COMPACT SHORT-RANGE TRANSMITTER

"Radio Mike," a compact, portable, transmitter described in *RCA Review*, was designed for short-range communication in the range between 23 and 30 mc. It is useful for broadcast and telecast relays, emergency services, and portable amateur operation.

speech amplifier is required if a single microphone unit is used.

This circuit incorporates an automatic modulation control. A portion of the output of the modulator is rectified by a 1N34 and applied to the control grid of the 1L4. When the sound input

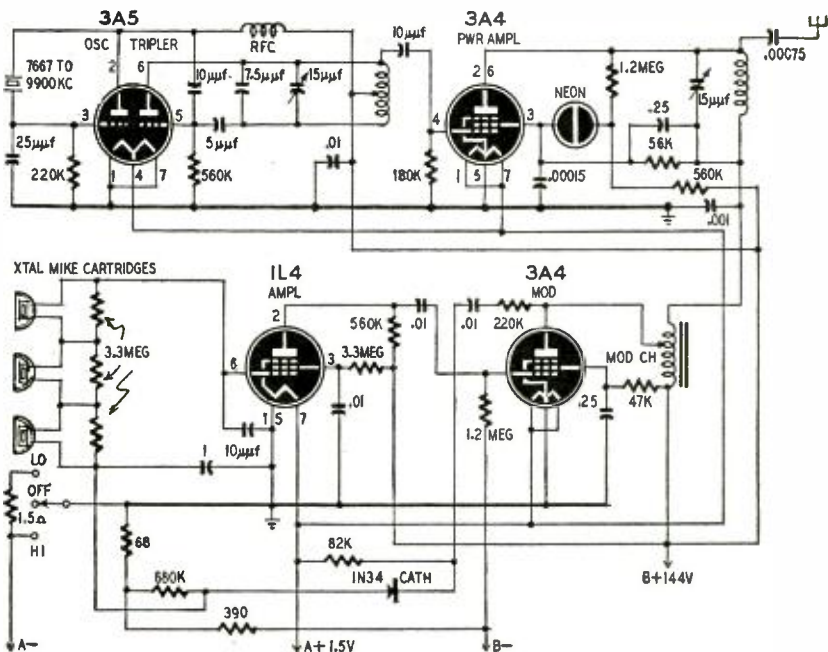

The r.f. section consists of a 3A5 Pierce oscillator and regenerative—overneutralized—tripler driving a 3A4 power amplifier. The antenna is a 20-inch length of thin aluminum tubing coupled to the transmitter through a spring-type loading coil. Measured output is 250 milliwatts.

A neon-lamp tuning indicator and pilot lamp is connected between the plate and screen of the power amplifier. When the switch is off, plate and screen voltages are equal and the lamp does not glow. To tune the transmitter, adjust the tripler tuning capacitor for minimum brilliance, then tune the power amplifier for maximum brilliance.

The audio circuit consists of a 1L4 speech amplifier and a 3A4 modulator. Three crystal microphone cartridges are connected in series so their additive outputs will be sufficient to drive the modulator from the 1L4. An additional

exceeds a preset level, the 1N34 develops a negative voltage high enough to lower the gain of the 1L4.

The power switch has three positions. In the LOW position, a 1.5-ohm resistor is inserted in series with the A-minus line to reduce the plate and filament power drains. This resistor drops the filament voltage to 1.1 volts with a new 1.5-volt battery. When the battery begins to drop off, the switch is thrown to HIGH. Battery drain will be reduced if reliable contacts can be had with the switch in the LOW position.

The transmitter and batteries are in an aluminum case 4½ x 3½ x 10 inches. Entire unit weighs six pounds.

Suggested coil data for 10- and 11-meter operation is as follows: 22 turns of No. 20 d.c.c. tapped at the center for the 3A5 tripler, and 13 turns of No. 20 d.c.c. for the 3A4 final amplifier. Both coils may be wound on ¾-inch forms.

### OSCILLATOR CIRCUITS USING TRANSISTORS

The circuit of an audio oscillator (Fig. 1) using a Raytheon CK-703 transistor is reprinted by courtesy of Cornell-Dubilier Electric Corp. It is a Hartley-type oscillator using the primary of a microphone transformer as the feedback winding. The primary is tuned to the desired frequency by selecting a suitable value for the capacitor across the secondary. The 1,000-ohm resistor in the cathode or germanium base return should be adjusted to give the greatest stability with least distortion.

Be sure that the battery polarity is as shown on the diagram. The collector C will burn out if polarity is reversed.

Fig. 2 is a diagram of a transistor-type crystal-controlled r.f. oscillator demonstrated by the Signal Corps at

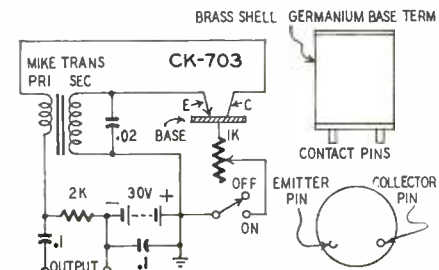

Fig. 1—Transformer supplies feedback.



the recent Radio Engineering Show in New York. Power input to the collector is approximately 60 milliwatts, and

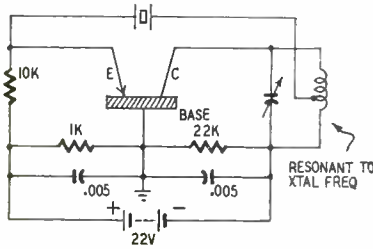
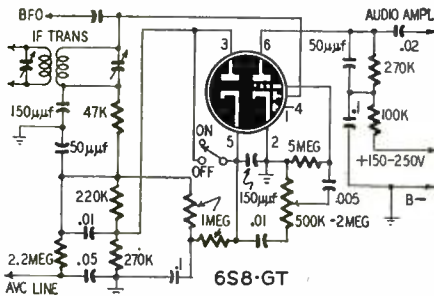

Fig. 2—Crystal controls the frequency.

output is 10 milliwatts. The circuit oscillates on a frequency close to the series-resonant frequency of the crystal. The coil and capacitor are selected to tune to the crystal frequency.

**6S8-GT IN AMATEUR RECEIVERS**

The diagram shows how a 6S8-GT can be used as second detector, a.f. amplifier, series noise limiter, and



source of a.v.c. voltage in amateur, portable, and mobile 6-volt receivers. The triode section is—for all practical purposes—equivalent to that of a 6Q7 or 6SQ7. A 6H6 will work as the noise limiter but it requires an extra socket and draws an additional 300 ma from the heater supply. A 1N34 could be used in the noise limiter circuit, but we have found that it will not work well on strong noise pulses and its bias voltage is critical. The a.n.l. components have been selected to have the circuits work at levels above 95% modulation.

This circuit can be added to many existing receivers. If the set has a 6H6 detector, its socket can be rewired for

the 6S8-GT. The a.f. amplifier socket can be rewired for an additional i.f. stage, b.f.o., or secondary frequency standard. A 6SS7 or similar 150-ma tube will effect a saving in heater current. A 12S8-GT can be used in a.c.-d.c. equipment.—L. H Trent

**CRYSTAL ABSORPTION METER**

Because of its high Q, a crystal makes a very selective absorption meter. The crystal can absorb a considerable amount of r.f. energy from a nearby tank coil. One terminal of the crystal may be grounded and the other left free. Alternatively, the crystal may be coupled to the circuit through a small capacitor. In either case, the r.f. energy dips sharply as the circuit is tuned to the frequency of the crystal.

The figure shows how a crystal is used to check the calibration of a v.f.o. As the tank is tuned through crystal resonance, there is an abrupt loss of excitation to the following stages. A grid or plate meter in the final will indicate when this occurs. If two or three crystals are available, it is easy to calibrate the v.f.o. at several points without using a crystal standard and a receiver or more elaborate calibrating equipment.—W2OUX

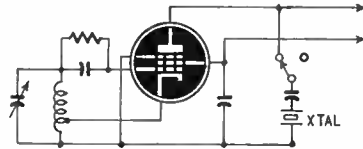

**PHOTOFACT BOOKS HELP YOU 4 WAYS!**

- 1. SAVE TIME
- 2. SAVE WORK
- 3. EARN MORE
- 4. LEARN MORE



**PHOTOFACT TELEVISION COURSE**

The book bought and studied by thousands. Gives you a clear understanding of TV principles, operation and practice. Complete coverage of all phases. 216 pages; profusely illustrated; sturdily bound, 8 1/2 x 11".

Order TV-1.....Only \$3.00

**TELEVISION ANTENNAS**

All you need to know about TV antennas—describes all types, tells you how to select, how to install, how to solve troubles. Saves time; helps you earn more. 166 pages; illustrated; handy pocket size.

Order TAG-1.....Only \$1.25

**THE RECORDING & REPRODUCTION OF SOUND**

A complete, authoritative treatment of the entire subject, written by Oliver Read, editor of Radio News. Covers all phases of recording and amplification. 364 pages. 6 x 9", cloth binding.

Order RR-1.....Only \$5.00



**1948 RECORD CHANGER MANUAL**

Covers 45 models made in 1948, including LP and dual-speed changers, plus leading wire recorders. Entirely original data based on actual analysis of the equipment. Over 400 pages; de luxe bound, 8 1/2 x 11".

Order CM-2.....Only \$6.75

**AUTO RADIO MANUAL**

Complete PHOTOFACT Service data on more than 100 post-war auto radio models. Complete, accurate, uniform information. Makes auto radio servicing easier and more profitable. Over 350 pages. Sturdy binding, 8 1/2 x 11".

Order AR-1.....Only \$4.95

**NEW! DIAL CORD STRINGING GUIDE**

New Volume 2, covering receivers produced from 1947 through 1949. The only book that shows you the one right way to string a dial cord in thousands of receivers. Handy pocket size.

Order DC-2.....Only \$1.00

**HOWARD W. SAMS & CO., INC.**

Order from your Parts Jobber Today, or write direct to HOWARD W. SAMS & CO., INC., 2201 E. 46th St., Indianapolis 5, Ind.

My (check) (money order) for \$.....enclosed. Send the following books:

- TV-1
- RR-1
- AR-1
- TAG-1
- CM-2
- DC-2

Name .....

Address .....

City .....Zone.....State.....

Presenting... NEW ADDITIONS TO THE

**Seletron**

SELENIUM RECTIFIER FAMILY

joining the more than 2,000,000 in service in Radio and Television!

551

**Designed Especially for Power and Bias Supplies in Television**

NOW SELETRON brings you these two new models ideally suitable in size and rating: No. 551 at 500 Mils — No. 8Y1, the "baby" of them all, measuring only 1/2" square and rated at 15 Mils, 130 volts. While these rectifiers are designed to meet television needs, engineers will find many applications for them in other electronic circuits. Other bias type rectifiers rated up to 250 volts will also be available.

A new leaflet on Bias Type 8Y1, describing its circuit possibilities is available. For a copy, write Dept. RS-26

SELETRON DIVISION  
**RADIO RECEPTOR COMPANY, INC.**  
Since 1922 in Radio and Electronics  
 Factory: 64 North 5th St., Brooklyn 11, N. Y. • Sales Department: 251 West 18th St., New York 11, N. Y.

# TELEVISION SCOPE

## SUPERIORITY AT A GLANCE!

The vertical response of this economy TV scope is usable to 5000 kc, not 50 kc. Response is flat to 750 kc, down 3 db at 1000 kc. Amplifier supplies a voltage gain of 20 at 5000 kc.



AR-3

Check this necessary feature before you buy any scope for TV use.

The R.S.E., AR-3 Scope has been built by Ross Armstrong to our rigid specifications. It's a complete unit that embodies standard horizontal amplifier and sweep circuits with normal sensitivity.

The case is 8" high x 5" wide x 14" long, attractively finished in "hammered" opalescent blue enamel. Operates on standard 110 volts—60 cycles—40 watts. Tubes, 3BP1-6AC7-6SJ7-6X5-5Y3-884. Instructions included. Complete specifications upon request. Satisfaction or your money back.

PRICE \$4995

AVAILABLE TO JOBBERS IN QUANTITY

F. O. B. DETROIT

# INTERCOM & RADIO

AT A PRICE THAT CAN'T BE BEAT



6 tube superhet—3 tube intercom permits communication between radio-master and up to 4 sub-stations.

WHILE THEY LAST \$2995

With 1 sub-station and 50 feet of cable Extra Sub-stations \$3.95 each

Original cost \$64.50

# PUSHBACK WIRE



25% BELOW MILL COST!

1st class, Essex or Lens, ALL SOLID tinned copper, double cotton serve, waxed finish.

SIZE	COLORS	100 feet	1000	Production Reel
22	BLACK-BROWN	.39	3.79	3.65M
20	RED-WHITE-BLUE	.49	4.49	3.95M
18	BROWN	.69	5.98	

## ORDER INSTRUCTIONS

Minimum order—\$2.00. 25% deposit with order required for all C.O.D. shipments. Be sure to include sufficient postage—excess will be refunded. Orders received without postage will be shipped express collect. All prices F.O.B. Detroit.



Quantity and Export Orders Solicited

**RADIO SUPPLY & ENGINEERING CO., Inc.**  
85 SELDEN AVE. DETROIT 1, MICH.

# Hi-Volt Electrostatic Generators

TWO new electrostatic generators, developing 20,000 and 6,000 volts, respectively, and weighing only about 10 pounds each, were disclosed by the Army Engineer Research and Development Laboratories at Ft. Belvoir, Va.

Designed for use as a high-potential power supply for electron image tubes, the generators are driven by a spring motor with a manually operated governor. The 14-1 gear ratio between the generator and the driving motor makes possible continuous operation for 19 minutes on a single winding.

The generators consist of a spring motor driving a rotor made up of plastic laminated with metal foil. As the rotor turns between stator plates (already given an initial charge), a voltage is built up by induction on the metallic foil. At the proper moment, the voltage is picked off the foil by means of brushes 6 and 7 and is transported to the stator plates.

The figure shows how the generators work. The two insulated metallic stator plates are designated 1 and 2. Metallic rotor segments 3 and 4 are mounted diametrically on a Lucite rotor blade. If stator plate 1 is given an initial positive charge and rotor segment 3 is caused to approach stator plate 1, the electrons in this rotor segment are attracted to the side of the segment facing the stator plate 1 and leave the other side of the same segment positively charged.

Simultaneously, the charges on rotor segment 4 are segregated in the same way by the influence of stator 2. If at this instant the rotor segments come in contact with electrically interconnected brushes 5, electrons will flow from segment 4 to segment 3, thus leaving

segment 3 negatively charged and segment 4 charged positively.

When the rotor is caused to rotate 180 degrees, negatively charged segment 3 moves toward negative stator plate 2, while positively charged segment 4 moves toward positive stator plate 1. As the segments approach this position, they are respectively dis-

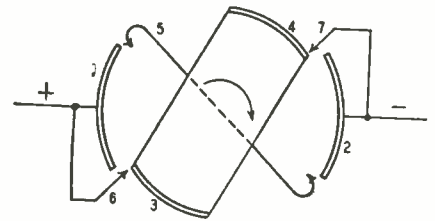

How the static charges are built up.

charged by brushes 6 and 7 which transfer the charges to the stator plates. The rotor segments then contact the interconnected brushes 5 and again assume influence charges because of their proximity to the charged stator plates.

By continuously turning the rotor, this cycle is repeated and stator plate 1 becomes increasingly positively charged while stator plate 2 becomes increasingly negatively charged. If several pairs of rotor segments are put on the rotor, the rate of building up the charge on the stator plates is increased for a given speed of the rotor.

The initial charge is placed on the plates by a manually operated friction-type electrostatic generator which appears as a small knob on the side of the generator housing. After the initial charge, the process of building up the voltage and transporting it to the plates is continuous as long as the rotor

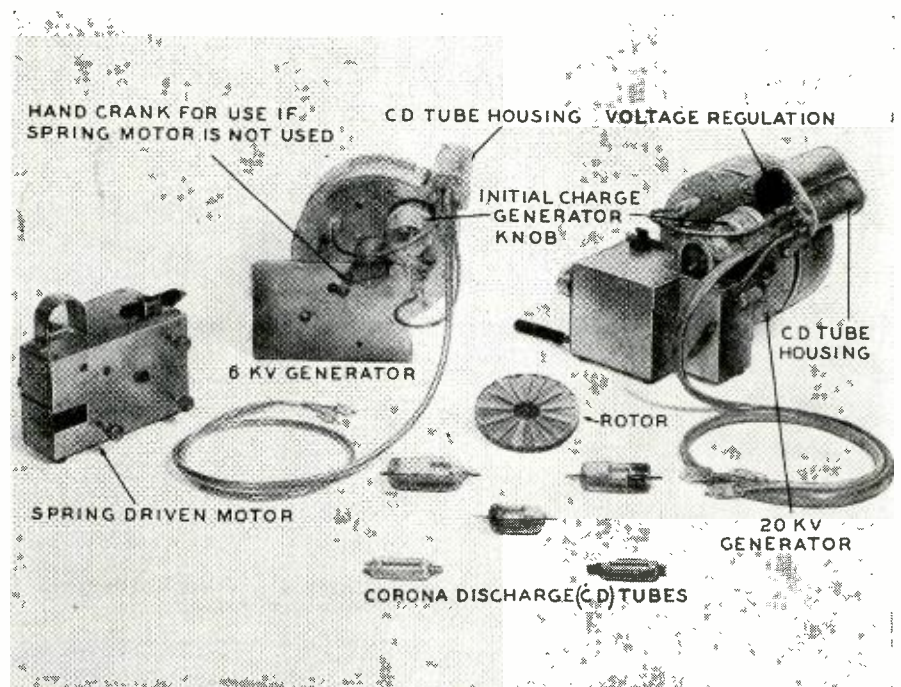

These portable generators supply high voltages for low-current applications.

RADIO-ELECTRONICS for

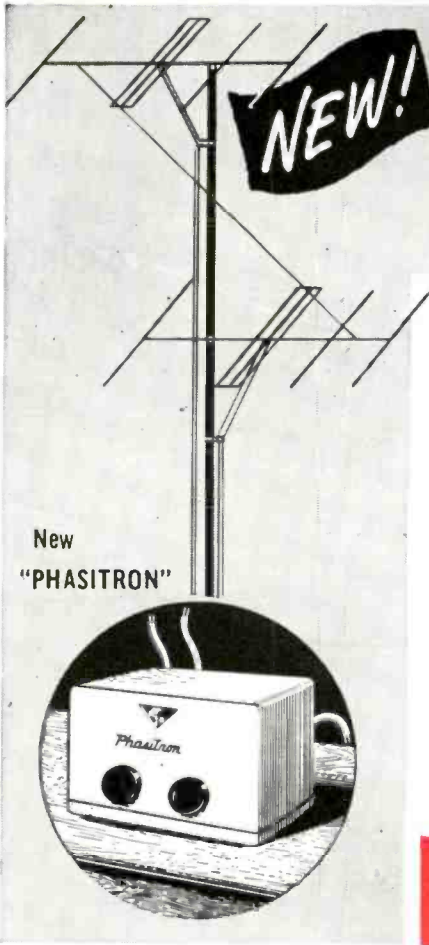

# The TRIO "CONTROLLED PATTERN"

PATENT APPLIED FOR

TV ANTENNA SYSTEM MODEL 604

*Eliminates Venetian Blind Effect!*

USES NEW "PHASITRON" and DOUBLE DIPOLE YAGI

ELIMINATES CO-CHANNEL INTERFERENCE

With 17 db Gain in Forward Direction!

TRIO MFG. COMPANY takes pride in announcing the greatest advance in TV antennas for fringe areas. It's the new TRIO "Controlled Pattern" Antenna System, the culmination of extensive research by G. N. Carmichael, TRIO's Chief Engineer, and one of the nation's foremost antenna authorities.

The new lightweight, yet rugged antenna not only provides terrific gain in the forward direction, but overcomes that ever increasing problem in fringe areas — co-channel interference. This is how the unique system works: high voltage from two double dipole Yagis is phased by the use of the new tunable "PHASITRON" to provide addition of voltages from the desired direction and cancellation of undesired voltages.

How well the system works is demonstrated by the fact that with voltage ratios up to 25 to 1, i.e., one signal is 25 times as strong as the other, the signal from the weaker will provide a sound carrier free from chatter and a picture free from venetian blind effect. The "PHASITRON" also permits tuning for maximum signal regardless of changing vertical wave angle. Uses two 300 ohm feed lines of random length, two DOUBLE-FOLDED Yagis for exact impedance matching. Separate antenna systems available for each of 12 channels, though considerable gain achieved on adjacent channels.

New  
"PHASITRON"



FOR FULL DETAILS WRITE FOR ILLUSTRATED FOLDER

©1950 by

**TRIO MANUFACTURING COMPANY**

GRIGGSVILLE, ILLINOIS

is in motion. The charges accumulated on these plates are the source of the high voltage.

Availability of new insulation materials, new plastics, and new techniques of hermetic sealing made the development of these generators possible. A "pressure-tight transmission" permits the application of a rotary motion into a pressurized generator housing.

A concurrent development, the corona discharge regulator tube, makes possible excellent voltage regulation without the use of power-consuming resistance-type voltage dividers. This tube acts as a kind of safety valve by limiting the voltage and thus maintaining it at a specified value.

## ULTRASONIC SOLDERING

**A**N ULTRASONIC soldering gun has been developed that will successfully solder aluminum and other metals and alloys which form oxide films under normal atmospheric conditions and will not respond to ordinary soldering methods.

The new soldering gun has the normal type of copper tip heated in the usual manner by a resistance winding. The copper tip is secured to a brass block which in turn is held in firm contact with the nickel core of a magnetostriction transducer. A winding around the transducer provides the excitation.

In application, the tip of the gun is allowed to heat to the operating temperature. The transducer is then ener-

gized and the tip is tinned by applying a soft solder. The tip is applied to the work and solder is fed in the usual way. It is essential to keep a good liquid contact between the tip and the work for maximum acoustical efficiency.

The effect of the ultrasonic vibration is to destroy the oxide surface temporarily and leave a clean surface for the solder.

The power needed to supply the magnetostriction unit is supplied by an



electronic amplifier that operates directly from the a.c. lines. The output frequency is obtained by feeding back the resonant frequency of the vibrating element to the amplifier input by means of a coil on the element. The operating frequency is chosen well above the normal audible range so that no discomfort is experienced by the operator.

The ultrasonic soldering gun was developed in the Mullard Research Laboratories in London.

## PEN-OSC-LITE

Extremely convenient test oscillator for all radio servicing; alignment • Small as a pen • Self powered • Range from 700 cycles audio to over 600 megacycles u.h.f. • Output from zero to 125 v. • Low in cost • Used by Signal Corps

Write for information.  
**GENERAL TEST EQUIPMENT**  
38 Argyle Ave. Buffalo 9, N. Y.

**HOW** Learn how to simplify radio repairs **FREE!** Send penny postcard for big 32-page illustrated **FREE MANUAL**. No obligation.

**FEILER ENGINEERING CO., Dept. 5RC5B**  
1601 S. Federal St. Chicago 16, Illinois

## GREYLOCK RADIO TUBE BARGAINS!

GT. Glass and Miniature Types

1A4P	1U5	6BA7	6U7G
1A5	3A4	6BE6	6V6GT
1C6	3Q4	6BM6	6X4
1F4	6AQ5	6CS8T	6X5GT
1SS	6AT6	6K6GT	12AB6T
1T4	6AU6	6SK7GT	12A6
1U4	6BA6	6SQ7GT	

**\$34.95**  
per 100 ea. st.

Also available in smaller quantities at 39¢ each.



**SPEAKER SPECIALS!**  
3", 4", or 5" PM. less output. Alnico  
B, each ..... 97c  
In cartons of 30, each ..... 87c  
6" x 9" Oval PM. Alnico S, 3.16 oz.  
magnet, each ..... \$2.39  
In cartons of 24, each ..... \$2.39

TERMS: Net C.O.D., F.O.B. NYC.

MINIMUM ORDER \$10.00.

Write for terrific CR tube prices and Bargain Catalog C-5

**Greylock Electronics Supply Co.**  
115 Liberty Street New York 6, N. Y.

**THE FINEST 16" TELEVISION SET EVER DESIGNED!**

With Automatic Gain Control (AGC)

Now you can have the finest 1950 model Voltage Doubler Giant Screen Television Set ever designed. Custom built and improved with unusually high brilliance—will give you thousands of hours of fine entertainment during day or evening hours. A bright, clear steady picture is assured by the most famous television set ever produced, the RCA designed 630 type chassis. This identical type TV set is used by more Radio & TV Engineers than any other set ever manufactured!

The 30 tube circuit is more sensitive than any of the cheaper sets having less tubes and the new Standard Tuner has a pentode RF stage which acts as a high-gain built-in Television Booster on all channels. Also featured is an automatic frequency control system that keeps the picture steady and makes tuning easier.

Factory wired and tested, ready to operate. Shipped complete with tubes, less 16" picture tube **\$149.50**

Extra-Clear 16" glass picture tube—guaranteed for one year— **\$39.50**

**SPECIAL!**

Super-Giant 19" Television Set. 630 type similar to above, but modified to provide a whopper-sized picture. Factory-wired and tested, ready to operate. Shipped complete with tubes, less 19" picture tube. Price... **\$169.50**

Extra-Clear 19" glass picture tube—guaranteed for one year— **\$79.50**

12½" 630 chassis—\$149.50;

12½" tube—1 year guarantee—\$24.95

**DE LUXE TELEVISION CABINETS**

Beautifully designed to match the 630 chassis without any cutting or drilling. Solidly constructed like the finest furniture with a satiny piano finish. Shipped complete with mask and protective glass window.

16" Table Model—Mahogany or Walnut **\$39.95**

19" Table Model—Mahogany or Walnut **\$44.95**

16" Console—with drop panel to conceal knobs when desired. Mahogany or Walnut... **\$69.50**

Blonde... **\$79.50**

19" Console—with drop-panel as above—Mahogany or Walnut... **\$79.50**

Blonde... **\$89.50**

**CUSTOM AUTOMOBILE RADIOS To Match Popular Cars**

RADIOMEN! Here's your chance to make large extra profits with practically no work! All you have to do is get in touch with the local Ford, Plymouth, Dodge and Chevrolet dealers telling them that you can supply custom-built radios to perfectly match the 1949 and 1950 models of these cars for about ½ the price that is usually charged! Very simple installation—no holes to drill. SPECIFICATIONS—Powerful 6 tube super-heterodyne; 3 gang condenser with extra stage of RF; latest miniature tubes; oversize loud speaker. When ordering specify Ford, Dodge, Plymouth or Chevrolet. List Price \$42.95.

YOUR COST **\$34.97**

**TWO STATION INTER-COMMUNICATION SYSTEM**

Radiomen—provide yourself with an additional source of income by selling and installing these high quality—low cost intercoms.

Selling Features: • For the nursery (baby sitting) or sickroom • In private homes—room to room—garage to house—basement to attic, etc. • Busy businessmen • Ideal for use in television antenna installation and servicing—instead of unhandy earphones • Simple installation—only 2 wires to connect • Housed in an attractive walnut case, 1 master and 1 slave station, complete with tubes.

Price... **\$10.95**

Extra for 50 feet twin-lead cable... \$1.00

For complete listings of special buys for experimenters, radio technicians, laboratories, schools and engineers. Write for catalog T-5.

**RADIO DEALERS SUPPLY CO.**

154 GREENWICH ST. NEW YORK 6, N. Y.

**ELECTRONIC LITERATURE**

Any or all of these catalogs, bulletins, and periodicals are available to you if you write to us on your letterhead (do not use postcards) and request them by number. Send coin or stamps where cash is required. We will forward the request to the manufacturers, who in turn will send the literature directly to you. This offer void after six months.

**My-1—GASOLINE GENERATOR BOOKLET**

An eight-page booklet has been issued by D. W. Onan & Sons describing their complete line of gasoline-driven electric plants ranging from 260 to 35,000 watts, in all standard voltages, frequencies, and phases. Special accessories, including automatic controls, fuel tanks, remote stations and wires, and two-wheeled dollies and trailers, are also listed. A model guide has been included which points out the different types of models and gives instructions for choosing the proper type, size, and starting method. An additional four-page booklet gives information on diesel electric plants. —*Gratis*

**My-2—STANDARD TUNER DATA**

Standard Coil Products Company, Inc., has issued a four-page bulletin giving schematic diagrams, mounting dimensions, and alignment procedures for the Standard TV tuners TV-101 and 201. A supplementary sheet gives data on tuner TV-250. —*Gratis*

**My-3—TV VIEWING TUBE BOOKLET**

This 20-page booklet details television picture tube and general-purpose cathode-ray tube characteristics, replacement tube data, base diagrams, suggestions for tube handling, and a concise description of cathode-ray oscilloscopes used in TV servicing. Published by the Radio Tube Division, Sylvania Electric Products Inc.

A new viewing tube replacement chart lists 120 tube types and shows interchangeable types, changes required for tubes of different face size and over-all lengths, service data for TV sets designed for obsolete tube types, and data for kit builders wishing to increase picture tube size. A total of 165 tube types ranging from 2 to 20 inches in size and using both electrostatic and magnetic deflection systems are covered by the booklet. —*Gratis*

**My-4—TEST EQUIPMENT**

A 12-page catalog issued by the Precision Apparatus Company describes their line of test equipment including signal generators, oscilloscopes, tube checkers, vacuum-tube voltmeters, and volt-ohmmeters. —*Gratis*

**My-5—SYNCHRONOUS GENERATORS**

Bulletin GEA-5415 of the General Electric Company describes high-speed synchronous generators for standby, portable, and prime source power. The 8-page booklet gives construction features and performance data of the generators which have ratings from 12½ kva to 1250 kva and speeds from 1800 r.p.m. to 514 r.p.m. —*Gratis*

**Technical Bulletins**

EACH \$1.00 Postpaid Foreign \$1.25

**Electrical Design and Construction**

These bulletins give you easy, accurate, dependable methods of designing and building electrical equipment. You just follow simple charts, tables and step-by-step instructions that tell how to figure correct size units to meet specific requirements.

**106 Rewinding Electric Motors**—Enables anyone without electrical training to locate trouble, repair and rewind a.c. or d.c. motors and generators of all kinds; how to figure wire size and wind coils.

**111 Transformers**—How to design and build all types and sizes of transformers including specials for Neon tubes and ultraviolet lamps. Easy methods of determining core dimensions and wire size.

**152 House Wiring**—Safe, approved way to wire new and old buildings. Shows many different circuits. Explains how to use latest type of materials including fittings, fixtures. Also gives estimating methods.

**101 Resistance Wire**—How to use Nichrome and similar wire in heating devices, rheostats and resistance coils. Figuring wire size and length; how to wind elements and test. Also supply directory.

**113 Solenoids & Plunger Magnets**—How to make these a.c. and d.c. magnets having movable plungers to control other equipment. How to figure dimensions, plunger stroke, wire size, etc.

**112 Electromagnets**—How to design and build all types and sizes for a.c. and d.c. How to figure lifting power, wire size.

**148 Relays**—Designing and building a.c. and d.c. relays of any size for various purposes where small currents and voltages must control heavy circuits. Includes control systems for motors and machines.

**137 Meters**—Designing and building ammeters, voltmeters, wattmeters, for a.c. and d.c. Includes complete information on calibrating.

**127 Small Electric Light Plants**—Easy-to-build, low-cost installations for cottages, camps, etc. Includes a 110-volt, seven 25-watt-lamp system; also a 6-volt system using auto generator.

**151 Electric Power from Streams**—How to survey streams, estimate requirements and available power, design and build dams, select and install the control system and electrical equipment.

**161 Burglar Alarms & Time Switches**—Dependable types for various purposes. Time switches made for alarm clocks and arranged to control lights, sprinkler systems, motors and other devices.

**144 Choke Coils**—How to design and build for many different purposes. How to use these instead of rheostats for voltage control, safely and with much less loss of electricity

**131 Remote Control of Electrical Devices**—Circuits and applications. How to use telephone dial and Stroger switch. For experimenters and model-railroad switching purposes.

**134 A.C. Electrical Experiments**—Fascinating, harmless experiments for education and entertainment. Also practical uses.

**TECHNIFAX, 110 N. Franklin St. Chicago 6, Ill.**

Enclosed find \$\_\_\_\_\_ for which send the following Technical Bulletins at \$1.00 each (Foreign \$1.25) as indicated by numbers:

\_\_\_\_\_

\_\_\_\_\_

\_\_\_\_\_

Name \_\_\_\_\_

Address \_\_\_\_\_

City & State \_\_\_\_\_

RE-5-50

**My-6—TV AND FM COILS**

An eight-page catalog issued by the Stanwyck Winding Co. describes their TV and FM coils. The catalog contains replacement data as well as circuit diagrams in which the coils are used.—*Gratis*

**My-7—RUGGED INSTRUMENTS**

A 12-page booklet put out by the Marion Electrical Instrument Co. describes their "ruggedized" electrical instruments. The booklet gives in detail the construction features which make the instruments rugged and describes performance tests which the instruments must undergo.—*Gratis*

**My-8—GE HAM NEWS**

*Ham News*, bimonthly publication of the General Electric Company, is now available on a yearly subscription basis for those who find it difficult to obtain each issue. Subscription blanks are obtainable at any G-E tube distributor. *Ham News* will still be available on a free basis if picked up at a distributor's headquarters.—*Rate \$1.00 per year.*

**My-9—PRECISION RESISTOR CATALOG**

A catalog of 36 pages with information on their line of precision wire-wound resistors and resistive devices for sound equipment has been issued by the Cinema Engineering Co. An interesting feature is a kit for making wire-wound resistors up to 5% tolerance without the use of instruments.—*Gratis*

**My-10—TV TUBE GUIDE**

A 56-page television receiver tube complement book, listing by make and by model the number and type of receiving and picture tubes used in more than 620 sets, has been issued by Sylvania Electric Products, Inc. The book contains a chart showing the percentage of each of 136 receiving tube types used in TV sets distributed by 85 manufacturers and also a list with names and addresses of 80 TV set manufacturers. Replacement data is given for 120 TV picture tube types.—*Price 75¢.*

**My-11—TRANSMISSION LINE**

Bulletin No. 5 of the Andrew Corporation describes their Type 450 rigid transmission line and accessories for AM and FM. An accompanying bulletin, No. 49, is a price list for the equipment.—*Gratis*

**My-12—TV INSTRUMENTS**

Signal generators, a field strength meter, TV and FM tuners, a custom built TV receiver, and other equipment is described in a 12-page catalog issued by the Approved Electronic Instrument Corp. Included are a signal generator kit and an FM and TV sweep generator kit.—*Gratis*

**My-13—TEMPERATURE REGULATOR**

An electronic temperature regulator for aircraft cabins and other uses in high-speed aircraft is described in a bulletin of the AiResearch Manufacturing Co. The device anticipates the rate of change of temperature.—*Gratis*

**HIGHEST VALUE**  
**ALL-ALUMINUM CONICALS**  
**At the LOWEST PRICE Anywhere!**

**"COMMANDAIR"**  
**ALL-ALUMINUM TV CONICALS (less mast)**

**TOP QUALITY CONSTRUCTION!**  
Elements made of high-strength, aircraft-type aluminum alloy for greater resistance against vibration and corrosion.

**HEAVY DUTY ELEMENT BRACKETS!...**  
Made with extra-long gripping surface for secure anchoring of elements. No wonder that "Commandair" Conicals will stay put in the face of strong winds, under the strain of ice and snow.

**UNIQUE BRACKET FLEXIBILITY!...**  
An important feature of these amazing Conicals is their unique flexibility, which permits easy conversion from a standard Conical to a 6-element front and 2-element reflector type.

**ENGINEERED FOR MAXIMUM GAIN!...**  
Improved signal-to-noise ratio produces brighter pictures with minimized fading.

**NOTE:** The "Commandair" Conical is also offered in a separate, lower-priced "Economy" Line... of partial steel construction... completely assembled... similar to its all aluminum counterpart in design and performance.

**JFD No. C660** — "Commandair" All-Aluminum All-Band Conical. List Price (less mast) **\$9.85**

**JFD No. C661** — Same as No. C660 but 1/4 wave-length stacked for extra gain and directivity. List **\$20.70**

Write for **FREE** literature completely describing the JFD "Commandair" Line of All-Aluminum TV Conicals.

**JFD MANUFACTURING CO., Inc.**  
6101 16th AVENUE, BROOKLYN 4, N. Y.  
FIRST IN TELEVISION ANTENNAS AND ACCESSORIES

**SOUND POWERED PHONES**  
**IDEAL FOR TV INSTALLATIONS!**

**COMPLETE TWO-WAY COMMUNICATIONS**  
Sets are ruggedly constructed of high quality lightweight Polystyrene plastic—engineered for extra long service. Practical, fool-proof operation guaranteed up to 1/2 mile. **NO BATTERIES OR ELECTRICITY REQUIRED!** Comes complete with 25 feet of two conductor line.

**UNCONDITIONAL 10-DAY MONEY BACK GUARANTEE** **SEND ONLY \$3.49**  
**SEND NO MONEY!** Just mail postcard today and pay postman only \$3.49 plus postage, or remit in full—postpaid.

**TWO UNITS COMPLETE POSTPAID**

**THE ROBIN HOOD COMPANY**  
Dept. RE-2, 314 Market St., Newark 5, N. J.

**My-14—CONNECTOR CHART**

The 1949 Cannon desk chart gives the insert arrangement of all type K connectors. Measuring 19 x 24 inches it contains 211 layouts with wire, contact, and clearance data. Major shell types and styles are shown with exploded views.—*Gratis*

**My-17—DUAL CONTROL DATA**

A 20-page manual containing replacement data for concentric dual controls has been put out by the International Resistance Co. The manual covers only those dual controls on which rear and panel sections are operated independently by concentric shafts. The listings are comprehensive, covering early prewar concentrics for home and auto radios and continuing up to television receivers appearing in the fall of 1949.—*Price 25¢*

**SHORT-WAVE**  
**in your CAR!**

**GONSET "3-30" Converter**

- attaches to your automobile radio
- continuous coverage 3 to 30 mc.
- four working (r.f.) tubes
- extremely compact

converter **\$39.95** noise silencer **\$8.25**

OTHER FREQUENCY RANGES (POLICE, MARINE, ETC.) ON SPECIAL ORDER.

see your dealer

**GONSET CO.**  
BURBANK, CALIF.

WHERE TO BUY IT . . .  
**WHOLESALE RADIO**  
 of Baltimore

**FLASH!** Just Received  
 The Sensational New **ANCHOR**  
**2 STAGE BOOSTER**

Operates in fringe areas formerly unworkable.  
 Will outperform any other booster. **\$26.97**

**Lowest Price Anywhere!**  
**Compare!**

**HI-BAND ADAPTER**

Folded dipole and reflector. Adjustable mounting bracket for complete orientation. Fits existing pole 1" to 1 1/2" di. Order model HP-3. **\$1.49**  
 \$1.35 ea. in lots of 6 or more.

**Sensational Antenna Buy!**  
**SNYDER HI-LO ARRAY**

Complete With Mast Sections  
**Model TV 21**

We don't believe you'll find a finer antenna anywhere near this low price. Two folded dipoles (High and Low) with reflectors. Complete with two 3 1/2 ft. mast sections. Easy ring. Ready for easy, quick installation. **\$5.95**  
 \$5.75 in Lots of 6 or More.

**T.V. ANTENNA ACCESSORIES**

High in Quality! Low in Price!

- STEEL EXTENSION POLES.** Weather treated.
- 10 Ft. Long, 1 1/4" di. . . . . \$1.49
  - 5 Ft. Long, 1 1/4" di. Crimped end. . . . . .89
  - 3 1/2 Ft. Long, 1 1/4" di. Crimped end. . . . . .69
  - ANTENNA SWIVEL BASE.** Aluminum. . . . . .39
  - Fits 1 1/4" O.D. mast section.
  - GUYWIRE.** 6 strands No. 20 per 50 ft. . . . . .29
  - 24 reels, 50 ft. each, interconnected. . . . . 6.00
  - 72 OHM COAXIAL CABLE RG59U**
  - 4c per ft. Per 100 ft. . . . . 3.75
  - 300 OHM TWIN LEAD** (\$1.45 per 100 Ft.) 1000 ft. 11.75
  - CHIMNEY MOUNT BRACKETS** Complete with strap. 1.39
  - 1 1/2"-300 OHM STAND-OFF INSULATORS**
  - Wood screw-in type, 3c ea. per 100. . . . . 2.75
  - WALL BRACKETS.** Adj. up to 18" from wall
  - Will hold masts 1" to 1 1/2" di. WB2. . . . . 3.75
  - SAMS TV ANTENNA MANUAL.** . . . . . 1.25
  - SNAP-ON TWIN LEAD INSULATORS.** Fit 1 1/4" masts . . . . . .08
  - FLOATING GUY RING.** Fits 1 1/4" mast. . . . . .09
  - MAST COUPLINGS.** Galvanized steel 8" long. . . . . .45
- Will couple masts of 1 1/4" or 1-5/16" di.

**For Complete TV Servicing**  
**9 TOOL TV SERVICE KIT**



In Leatherette Case  
 Here's the low-priced servicing kit you've been waiting for. Included the latest TV servicing tools for a complete servicing job. You get tran-aligner. Dual-aligner, slim aligner, cone-aligner, tuning wand, tuning wrench, deep-nib aligner, biz-stretch aligner, channel aligner, tuner, all for only **\$3.95**

**Build Your Own Booster**  
**And Save Over 50%**

**Techmaster**  
**TV. Booster Kit**



Complete with Tube, pre-aligned coils, stamped chassis and handsome cabinet. **\$9.95**

Improve TV reception in low-signal, low terrain and fringe areas by building this latest design booster. Tested to reduce noise from 3 to 5 db. Get brighter, sharper pictures you hardly thought possible. Simplified step-by-step wiring instructions.

WRITE FOR FREE MONTHLY "FYI" BULLETIN  
 ADDRESS ORDERS TO DEPT. QR 28  
 OR PHONE MULBERRY 2134

**WHOLESALE**  
**RADIO PARTS CO., Inc.**  
 311 W. Baltimore St.  
**BALTIMORE 1, MD.**

**ANIMATED WINDOW DISPLAY**

The photograph shows a novel attention-getter installed in the window of my radio shop in Brussels. The mounting for all the components is a piece of wood cut in the shape of a man's head. Over the parts is a second head silhouette made of Lucite.

The device is capacitance-operated. When a passerby approaches the window, a light goes on, illuminating the advertising text ("Put all the trumps in your game by buying here"); a toy motor turns a train of four gears, to each of which is attached a playing-card symbol; and a movable piece of wood uncovers the head's eye, giving the effect of a wink.

The diagram shows how it is done. The triode section of the 12SR7 is an oscillator, the coil of which was made from an old 55-kc i.f. transformer. Almost any other frequency can be used, but steer clear of those in the broadcast band. A 7-inch square of tinfoil glued to the window makes the tube stop oscillating when a person approaches.

The plate current of the 12SR7 is rectified by the two diode plates in parallel and applied to the grid of the 50L6 relay-control tube. When the 12SR7 stops oscillating, the 50L6 grid voltage becomes more positive, increasing the 50L6 plate current and closing the relay. The relay contacts light the 117-volt incandescent lamp which illuminates the sign and starts the motor which whirls the playing-card symbols.

A piece of wood, shaped as in the photo, is attached to the relay armature. When the relay closes, this piece,

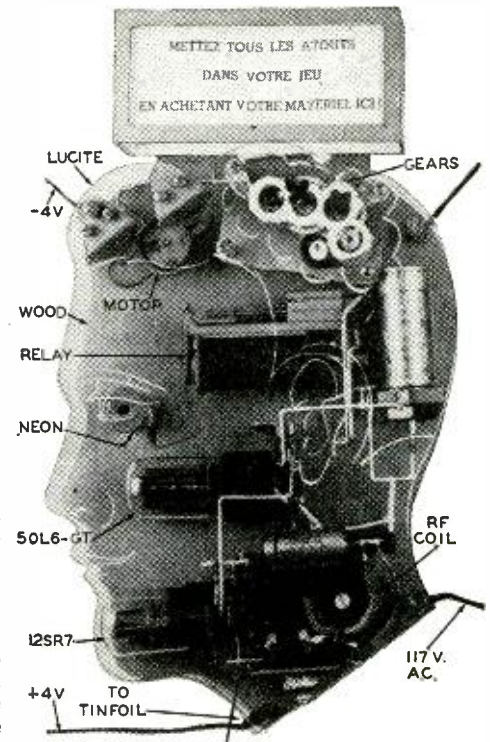

This elaborate capacity-actuated window display always attracts attention.

leads will be eliminated. Resistor R, in addition to dropping the line voltage for the series filaments, is tapped for 50L6 screen voltage. The tap is adjusted so that the relay opens when the oscillator is running and closes when it is not.

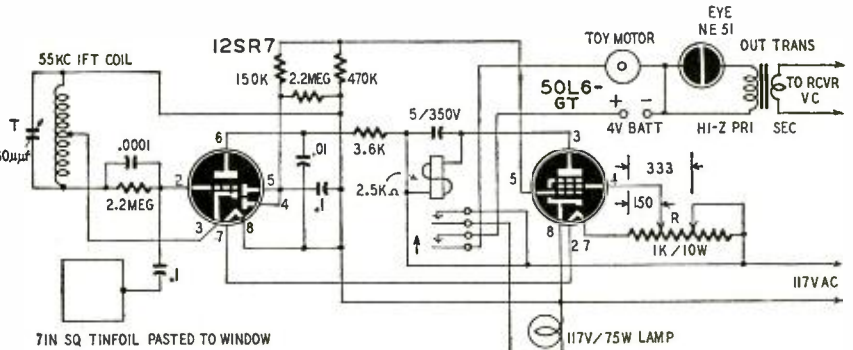

Body capacitance stops the oscillator to allow the 50L6 to operate the relay, which causes the Lucite figure's eye to wink, actuates a display and lights a sign.

normally between the neon lamp and the eye hole, is withdrawn so that the eye appears to light up.

The power supply is unrectified a.c. line voltage. A 4-volt battery (external) runs the motor; but, if a 117-volt motor is used, the battery and a pair of

The 117-volt and 4-volt leads are used to hang the head.

This display can be varied widely, of course, to suit different types of customers, but the human head idea seems to be a sure attention-getter.

—V. Fastenaekels

**CORRECTIONS**

The power transformer for the audio amplifier at the bottom of page 37 of the March issue is listed as 650 volts at 60 ma in the parts list. It should be 700 volts at 120 ma.

We thank Mr. James McDaniel, of Rosell, N. J., for this correction.

Substitute the letter I for the

numeral 1 in the equation for finding the capacitance of an input capacitor in "Power Pack Design" in the February issue. This equation is in the fourth line, third column, of page 44 of that issue.

Our thanks to Mr. Perry Booker, of Lyons, Kansas, for calling this printer's error to our attention.

Radio Thirty-Five Years Ago

In Gernsback Publications

**HUGO GERNSBACK**  
Founder

Modern Electrics.....	1908
Electrical Experimenter.....	1913
Radio News.....	1919
Science & Invention.....	1920
Television.....	1927
Radio-Craft.....	1929
Short-Wave Craft.....	1930
Television News.....	1931
Wireless Association of America.....	1908

Some of the larger libraries still have copies of ELECTRICAL EXPERIMENTER on file for interested readers.

**May, 1916, ELECTRICAL EXPERIMENTER**

- Locating Vessels at Sea by Radio and Sound Waves
- Modern Concepts of Electricity, by Samuel Cohen
- Latest Radio Telephone Apparatus
- Wireless Aids Uncle Sam to Catch Villa
- A Novel Mounting for Oscillation Transformer, by Philip C. Platt
- Magnetic Wireless Detector, by Frank Cusack
- A Cheap Hot Wire Ammeter, by Francis A. Pray
- Designing Spiral Aerial, by George L. Bowman
- Easily Adjusted Detector Stand, by Francis R. Pray
- Electrical Losses in Radio Transmitting and Receiving Sets, by James L. Green
- Use and Construction of a Wireless Telephone Set, by Milton B. Sleeper
- How to Make a Simple Electrolytic Interrupter, by Clyde G. Sykes

**TECHNICIANS REORGANIZE**

An important announcement by the (former) Philadelphia Radio Service Men's Association informs us that they have reorganized as an entirely new type of organization for electronic technicians.

The new Association, known as the Electronic Technicians Guild, will include in its membership independent radio technicians, employees in larger radio and television service establishments, radio and television dealers and distributors and their sales personnel. Shops will be classified and wage rates set, working conditions regulated and grievances between employers and employees arbitrated.

Committees will examine and grade all members. Attendance at meetings and technical lectures (or a technical school) will be compulsory until the Master Grade is reached. Attendance at meetings will continue to be required, so that the operating procedures of the organization will remain strictly democratic.

The new type of organization will be tried out in the metropolitan Philadelphia district, and if successful will be extended to other member groups of the Federation of Radio Servicemen's Association of Pennsylvania.

The step, taken by one of the oldest radio technicians' associations of the country, is very important and will be watched with great interest by organized radio service technicians all over the country.

MAY, 1950

**LE-Hi**

Guaranteed  
Pre-tested  
**RADIO TUBES**  
for QUALITY, PERFORMANCE  
and DEPENDABILITY

Every individual tube must undergo rigid tests before it leaves the Le-Hi plant. This guarantee of pre-testing is but one assurance of the BEST BUY from Le-Hi. Rugged construction, dependable performance and economical service at LOWEST PRICES make our tube even MORE DESIRABLE. Compare performance, quality and price with any standard tube—and remember EVERY Le-Hi Tube is FULLY GUARANTEED.

Type	Price	Type	Price	Type	Price	Type	Price	Type	Price	Type	Price
1A5	.57	5Y3GT	.39	6C6	.55	6SN7GT	.53	12Q7GT	.50	35L6GT	.47
1A7GT	.57	5Z4M	.86	6D6	.59	6S07GT	.39	12S8GT	.72	35W4	.39
1B3GT	.82	5Z3	.48	6E5	.39	6T8	.79	12SA7GT	.46	35Z4GT	.39
1B4P	.39	6A7	.69	6F5GT	.39	6U7G	.59	12SF5GT	.52	35Z5GT	.39
1C5GT	.70	6A8G	.56	6F6GT	.41	6V6GT	.46	12SF7GT	.53	36	.39
1C6	1.05	6A8A	.52	6F7	.39	6W4GT	.47	12SJ7GT	.49	37	.39
1C7G	.39	6AC5GT	.77	6F8G	.39	6X4	.39	12SK7GT	.44	38	.39
1F4	.39	6AG5	.56	6H6GT	.45	6X5GT	.39	12SL7GT	.61	39/44	.39
1G4GT	.39	6AK5	.87	6J5GT	.39	7A7	.59	12SN7GT	.53	41	.59
1H5GT	.45	6AL5	.43	6J6	.70	7B6	.59	12SQ7GT	.39	42	.59
1H6G	.39	6AQ5	.46	6J7GT	.49	7C4	.49	12SR7	.49	45Z5GT	.48
1N5GT	.57	6AR5	.40	6K5GT	.60	7C5	.59	12Z3	.39	46	.39
1P5GT	.86	6AS5	.47	6K6GT	.39	7F7	.59	198B6G	1.53	47	.39
1R5	.55	6AT6	.39	6K7GT	.49	7Y4	.49	19T8	.77	50B5	.47
1S5	.46	6AU6	.46	6K8GT	.59	12AL5	.43	24A	.59	50C5	.47
1T4	.56	6AV6	.47	6L5G	.39	12AT6	.39	25A7GT	2.02	50L6GT	.47
1T5GT	.86	6BA6	.44	6L6G	.78	12AT7	.72	25AC5GT	.87	53	.39
1U4	.55	6AW6	.65	6N6	.60	12AU6	.48	25B6G	.85	55	.39
1U5	.45	6BA7	.59	6P5GT	.55	12AU7	.58	25L6GT	.47	56	.39
1V	.39	6BE6	.46	6Q7GT	.50	12A8GT	.59	25W4GT	.47	57	.39
1X2	.68	6BF6	.40	6S7	.72	12AV6	.39	25Z5	.41	58	.39
2A7	.69	6BH6	.57	6SA7GT	.46	12AX7	.61	25Z6GT	.39	70L7GT	1.11
2X2	.69	6BJ6	.48	6SC7GT	.59	12BA6	.44	26	.50	75	.59
3A4	.39	6B5	.59	6SD7GT	.56	12BA7	.59	27	.39	76	.59
3A5	.39	6B8	.39	6SF5GT	.52	12BE6	.46	30	.39	77	.39
3O4	.62	6BQ6	.85	6SF7GT	.59	12BF6	.40	32L7GT	.91	80	.39
3Q5GT	.65	6BG6G	1.35	6SH7GT	.39	12J5GT	.40	33	.39	117LM7GT	1.11
3S4	.59	6C4	.39	6SJ7GT	.44	12J7GT	.55	35/51	.55	117P7GT	1.11
3V4	.60	6C5GT	.48	6SK7GT	.44	12K7GT	.47	35B5	.47	117Z3	.40
5U4G	.39	6BC6	.51	6SL7GT	.61	12K8GT	.49	35C5	.47	9002	.39

Distributors' and Jobbers' Inquiries Solicited

Each tube individually boxed. 50¢ handling charge on orders under \$5. Save 5% discount on orders of 100 tubes or more! All orders shipped C.O.D. Prices subject to change without notice.

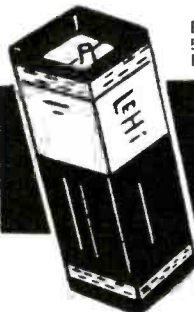

**LE-Hi ELECTRICAL COMPANY**

412 Halsey Street  
Telephone Market 3-8294

Newark 2, N. J.

**SIX TUBE SUPER**  
Three Gang Condenser

**\$33.30**  
NET  
Crowe Panel  
Kit Included



Panel kit to fit most all makes (Please specify make of car and year model). New up-to-date latest priced Catalog available to dealers.

**Bill Sutton's**

Wholesale Electronics  
5th at Commerce Fort Worth, Tex.

Downtown N. Y. Headquarters  
**T. V. ACCESSORIES**  
RADIO PARTS—TUBES

**A RADIONIC SPECIAL!**  
Stacked, All Band Conical  
TV array... at Lowest Cost

It's here! Scientifically designed, precision made, all-band conical TV array—giving tremendous gain and absolute minimum interference at a cost no greater than the usual dipole. Permits direct coupling to 72, 150 or 300 ohm line with minimum loss. All dual construction. 10 foot mast included. Amazingly low price of only \$11.75



In lots of 3, \$11.45 each

Best quality, 300 ohm twin-lead, 100 feet, \$1.10, 1000 feet \$9.95.

20% deposit with order, balance C.O.D.

**RADIONIC**  
EQUIPMENT CORPORATION

Tribune Theater Entrance  
170-KK Nassau Street :: New York 7, N. Y.  
WORTH 2-0421 :: Open daily 9 to 6—Saturday 9-5

**\* VOLOMETERS**

\*Reg. Trade Mark for Volt-Ohm-Milliammeter

from the New

**EMC**

**ECONOMY LINE**



**MODEL 104**  
(20,000 ohms per volt meter)

- 4 1/2" SQUARE METER (50 micro-amperes—al-nico magnet)
- Includes carrying strap
- 5 DC Voltage Ranges at 20,000 ohms/volt to 3,000 V.; 5 AC Voltage Ranges to 3,000 V.; 3 Resistance Ranges to 20 megs. Also 3 AC & DC Current Ranges & 5 DB Ranges.

**\$24.95**

**MODEL 102**

(1000 ohms per volt meter)

- 3" SQUARE METER
- 3 AC CURRENT RANGES (0-30/150/600 ma.)
- Same zero adjustment for both resistance ranges (0-1000 ohms, 0-1 meg-ohms)

5 DC & 5 AC Voltage Ranges to 3,000 Volts. Also 4 DC Current Ranges.

**\$13.90**



**MODEL 103**

(1000 ohms per volt meter)

- 4 1/2" SQUARE METER
- 3 AC CURRENT RANGES (0-30/150/600 ma.)
- Same zero adjustment for both resistance ranges (0-1000 ohms, 0-1 meg-ohms)

Same Ranges as Model 102. Also 5 DB Ranges.

**\$17.50**

Model 103-S with plastic carrying strap ..... \$17.95



All of the above have round cornered, bakelite, molded cases.

Export Dept., 303 W. 42nd St., N.Y.C.  
Write Dept. B-5 for Free Catalog

Gives More Measurement Value per Dollar!



**ELECTRONIC MEASUREMENTS CORP.**

423 BROOME STREET, NEW YORK 13, N. Y.

**BATTERY-POWERED PUBLIC ADDRESS SYSTEM**

? I would like to have a circuit of a battery-powered public address system which will deliver at least 1.5 watts. Please design the circuit to use a 1J6-G, 1H4-G, and a 1S5.—Wm. H. W., Maplewood, N. J.

A. The amplifier shown in the diagram will deliver 2 watts. The 1J6-G oper-

ates class B and is transformer-coupled to the 1H4-G driver stage. The ratio of the primary to half the secondary of the driver transformer should be approximately 2.4 to 1. The filament drain being heavy, a small 2-volt storage battery is recommended for the filament supply to save on battery expenses.

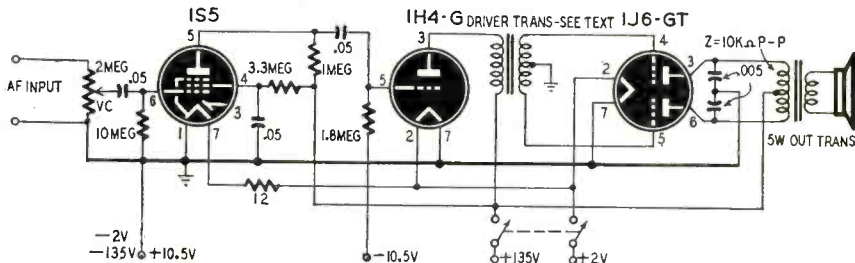

**PORTABLE AMPLIFIER FOR DICTAPHONE**

? Please print a circuit of a portable battery-powered amplifier which I can use as a dictaphone. The amplifier should be designed for use with crystal or carbon microphones. I plan to use crystal headphones with the unit.—T. C. B., Coronado, Calif.

microphone cables more than 50 or 60 feet, replace the microphone transformer with a line-to-grid transformer in the grid circuit of the 1U5. Install a mike-to-line transformer at each microphone. Select transformers made to match each microphone. Mount the batteries for the carbon microphone close to it.

A. The amplifier shown in the diagram should do the job for you. The grid of the first 1U5 speech amplifier can be switched to the crystal or carbon mike at will. If you are planning to run the

Adjust the pre-set control for the carbon microphone to avoid overloading the amplifier on loud signals. A separate switch cuts out the carbon mike.

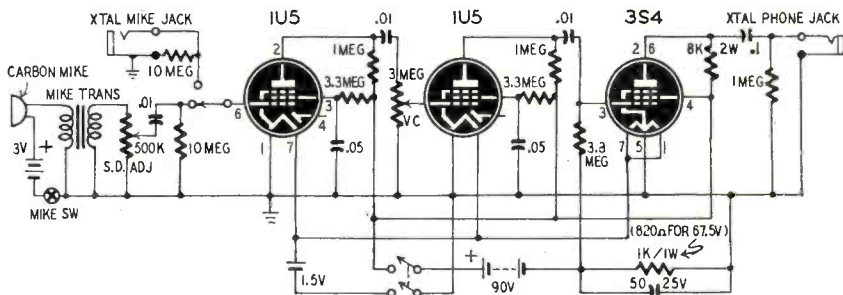

**RADIO-PHONO-TV SWITCHING CIRCUIT**

? I have a 500-ohm, 15-inch coaxial speaker, Admiral 30A16 TV receiver, a record changer with variable-reluctance cartridge, S-56 Hallcrafters AM-FM receiver, and an ACA 100GE amplifier with a built-in equalizer and preamplifier for variable-reluctance pickups. Please show how these units can be interconnected by switches so the speaker—and amplifier, if neces-

sary—can be used with all units.—P. L. P.—Philadelphia, Penna.

A. One switching circuit is shown. Separate switches are used in the input and output circuits. A single multi-circuit switch could have been used; however, feedback is likely because of coupling through the switch

The a.f. signal from the TV receiver

**AERO (Television) TOWERS**

TS (Tube & Strap Constr.) Tower Kits 10'-60'; A (All Tube Constr.) Tower Kits 10'-80'; B—Heavy Duty (All Tube) Tower Kits 10'-120'; C—Super Heavy Duty (All Tube) Tower Kits 10'-150'.

**EP-ECONOMY POLE KITS**

(Including All Accessories)

10' EP Pole Kits—20' EP Pole Kits—30' EP Pole Kits. Manufacturers Reps., Distributors, Dealers—Write, wire or call for exclusive territory franchise. TOWER KITS and POLE KITS priced below all contemporary products.

AERO TOWER & ROTATOR DIVISION (The original all steel tube television tower mfg). Knepper Aircraft Service (Est. 1937) 1016-24 Linden St., Allentown, Penna., Phone 30247.

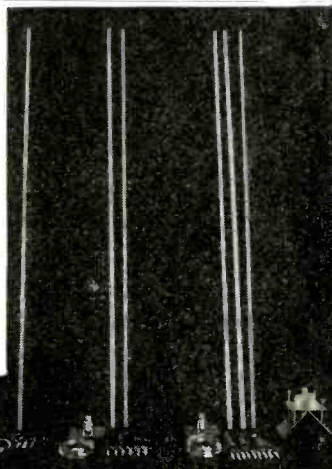
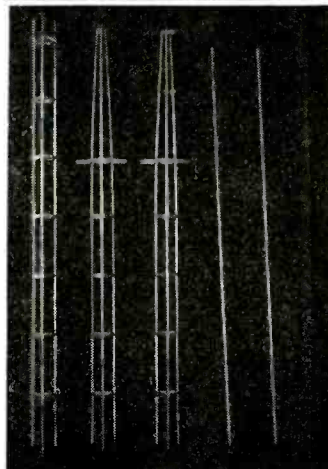



**NOW! PRESERVE EVERY TREASURED COPY of Your Favorite Radio Publications!**



**MAGAZINE LIBRARIES**  
Ingenious Custom-built Storage Files

Another Sensational Walter Ashe Value Scoop!

Made of high quality Kraft fibre board printed in rich colors and constructed to look like a Buckram bound book.

**RADIO-ELECTRONICS**

Only **25¢** plus 6¢ ea. to cover cost of pkg. & pstg. (anywhere in U.S.) Holds 12 complete issues based on present size of 82 to 98 pages. Measures 12" x 8 1/4" x 2 3/8".

**RADIO & TELEVISION NEWS**

Only **50¢** plus 15¢ per set to cover pkg. & pstg. Set holds 12 complete issues. Measures 12" x 8 1/4" x 2 3/8".

Only **25¢** **QST** plus 6¢ ea. to cover pkg. & pstg. Holds 12 complete issues. Measures 6 3/4" x 3 3/4" x 10".

Only **25¢** **CQ** plus 6¢ ea. to cover pkg. & pstg. Holds 12 complete issues. Measures 6 3/4" x 3 3/4" x 10".

Order Now for Immediate Delivery!

**Walter Ashe RADIO CO.**  
1125 PINE ST. PHONE CH. 1125 ST. LOUIS 1, MD.

**WALKIE TALKIES \$3.99 PER SET OF 2**  
POCKET SIZE  
—ELECTRONIC VOICE POWERED  
No tubes, batteries, adjustments, license or permit needed! Should last for years.  
Guaranteed to work anywhere up to 1/2 mile with extra wire. Clear tone. Swell for room to room—garage to house, etc. Your own private, talk-listen phone. Not war surplus. Brand new. Solid Aluminum Case. Guaranteed. Two absolutely complete units with wire—READY TO USE! Deluxe model has phone and mike in each unit. Swell for television antenna work.  
**SEND ONLY \$1.00** deposit and pay postman \$2.99 plus postage charges on arrival. Ideal gifts for boys—girls. Order Now! Today! **THE MIDWAY COMPANY, Dept. WRE-S, KEARNEY, NEBRASKA**

**IMPROVE YOUR TV SIGNAL**  
Easy new method tunes your Antenna to prevent standing waves. Plug-in type stubs Cover All channels. Kit \$3.95. Complete instructions.  
**ACE TV CO., 801 3rd St., Ocean City, N. J.**

is tapped off the top of the volume control and fed to the radio input jack on the amplifier through an R-C network and one side of the TV-PHONO switch. The TV volume control can be turned down or plug M201 removed from its jack while the amplifier is in use. The

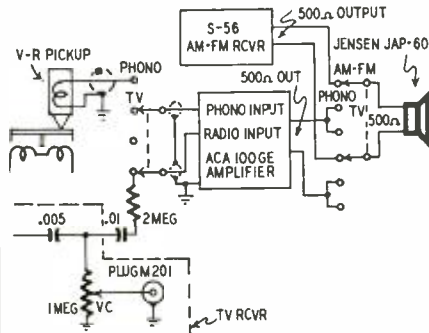

variable-reluctance pickup is connected to the phono input jack on the amplifier through the second pole on the TV-PHONO switch.

The S-56 has a high-fidelity amplifier with 500-ohm output terminals which can be used to feed the speaker without further amplification.

**POWER SUPPLY FOR BC-696**

? Please print a diagram of a power supply for a BC-696 transmitter. I have a power transformer which has a 1,200-volt center-tapped, 250-ma, high-voltage winding; two 12.6-volt filament windings; and a 5-volt, 3-ampere filament winding. I also have an 8.5-henry, 200-ma choke which I want to use.—*T.F.M., Sybial, W. Va.*

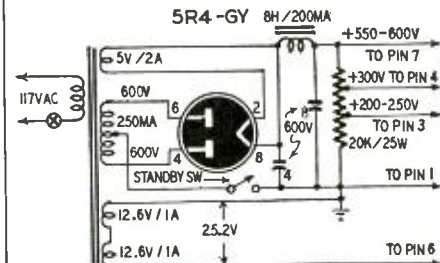

A. The components which you have should make an efficient power supply for the BC-696 or any of the other receivers in the SCR-274-N and ARC-5 command sets. The diagram is shown. The oscillator voltage may be reduced to 150.

Leads from the power supply connect to the numbered pins on receptacle J64 on the transmitter.

**C-R TUBE BASE CONNECTIONS**

? I have surplus 12DP7 and 12GP7 C-R tubes which I want to use in remote viewers as described in your January issue. Please print base connections for these tubes.—*A. A. P., Brooklyn, N. Y.*

A. Base connections for these tubes are shown.

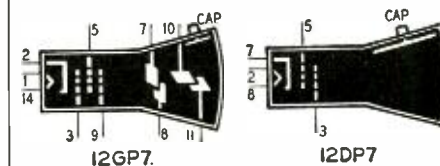

**You Don't Need a SLIDE RULE to Show Senco PRICES are EXTRA LOW**

**BRAND NEW IMMEDIATE DELIVERY TUBES INDIVIDUALLY CARTONED GUARANTEED**

SPECIAL QUANTITY DISCOUNT OFFER. Order 25 or More Assorted Tubes and Deduct 5¢ from the Price of Each Tube.

15¢ Ea.	2C34	78	1C6	75
1626	1626	85	1C7	81
E1148	185	VR53	1D5	89
	185		1D7	2051
	1R5		1D9	
	1R5		1E7	
	1R5		1F4	
	1R5		1G6	
	1R5		1G4	
	1R5		1G5	
	1R5		1G6	
	1R5		1H4	
	1R5		1H6	
	1R5		1I6	
	1R5		1P5	
	1R5		1R4	
	1R5		2B7	
	1R5		2S-45	
	1R5		3B7	
	1R5		6AUG	
	1R5		6B7	
	1R5		6D7	
	1R5		6F5	
	1R5		6G6	
	1R5		6J7	
	1R5		6K5	
	1R5		6K6	
	1R5		6K7	
	1R5		6P5	
	1R5		6S5	
	1R5		6S7	
	1R5		6S57	
	1R5		6S7	
	1R5		6V5	
	1R5		7A4	
	1R5		7B6	
	1R5		7E5	
	1R5		7K7	
	1R5		7L4	
	1R5		12AT6	
	1R5		12AU6	
	1R5		12BA6	
	1R5		12BE6	
	1R5		12C6	
	1R5		12D6	
	1R5		12E6	
	1R5		12F6	
	1R5		12G6	
	1R5		12H6	
	1R5		12J6	
	1R5		12K6	
	1R5		12L6	
	1R5		12M6	
	1R5		12N6	
	1R5		12O6	
	1R5		12P6	
	1R5		12Q6	
	1R5		12R6	
	1R5		12S6	
	1R5		12T6	
	1R5		12U6	
	1R5		12V6	
	1R5		12W6	
	1R5		12X6	
	1R5		12Y6	
	1R5		12Z6	
	1R5		12AA6	
	1R5		12AB6	
	1R5		12AC6	
	1R5		12AD6	
	1R5		12AE6	
	1R5		12AF6	
	1R5		12AG6	
	1R5		12AH6	
	1R5		12AI6	
	1R5		12AJ6	
	1R5		12AK6	
	1R5		12AL6	
	1R5		12AM6	
	1R5		12AN6	
	1R5		12AO6	
	1R5		12AP6	
	1R5		12AQ6	
	1R5		12AR6	
	1R5		12AS6	
	1R5		12AT6	
	1R5		12AU6	
	1R5		12AV6	
	1R5		12AW6	
	1R5		12AX6	
	1R5		12AY6	
	1R5		12AZ6	
	1R5		12BA6	
	1R5		12BB6	
	1R5		12BC6	
	1R5		12BD6	
	1R5		12BE6	
	1R5		12BF6	
	1R5		12BG6	
	1R5		12BH6	
	1R5		12BI6	
	1R5		12BJ6	
	1R5		12BK6	
	1R5		12BL6	
	1R5		12BM6	
	1R5		12BN6	
	1R5		12BO6	
	1R5		12BP6	
	1R5		12BQ6	
	1R5		12BR6	
	1R5		12BS6	
	1R5		12BT6	
	1R5		12BU6	
	1R5		12BV6	
	1R5		12BW6	
	1R5		12BX6	
	1R5		12BY6	
	1R5		12BZ6	
	1R5		12CA6	
	1R5		12CB6	
	1R5		12CC6	
	1R5		12CD6	
	1R5		12CE6	
	1R5		12CF6	
	1R5		12CG6	
	1R5		12CH6	
	1R5		12CI6	
	1R5		12CJ6	
	1R5		12CK6	
	1R5		12CL6	
	1R5		12CM6	
	1R5		12CN6	
	1R5		12CO6	
	1R5		12CP6	
	1R5		12CQ6	
	1R5		12CR6	
	1R5		12CS6	
	1R5		12CT6	
	1R5		12CU6	
	1R5		12CV6	
	1R5		12CW6	
	1R5		12CX6	
	1R5		12CY6	
	1R5		12CZ6	
	1R5		12DA6	
	1R5		12DB6	
	1R5		12DC6	
	1R5		12DD6	
	1R5		12DE6	
	1R5		12DF6	
	1R5		12DG6	
	1R5		12DH6	
	1R5		12DI6	
	1R5		12DJ6	
	1R5		12DK6	
	1R5		12DL6	
	1R5		12DM6	
	1R5		12DN6	
	1R5		12DO6	
	1R5		12DP6	
	1R5		12DQ6	
	1R5		12DR6	
	1R5		12DS6	
	1R5		12DT6	
	1R5		12DU6	
	1R5		12DV6	
	1R5		12DW6	
	1R5		12DX6	
	1R5		12DY6	
	1R5		12DZ6	
	1R5		12EA6	
	1R5		12EB6	
	1R5		12EC6	
	1R5		12ED6	
	1R5		12EE6	
	1R5		12EF6	
	1R5		12EG6	
	1R5		12EH6	
	1R5		12EI6	
	1R5		12EJ6	
	1R5		12EK6	
	1R5		12EL6	
	1R5		12EM6	
	1R5		12EN6	
	1R5		12EO6	
	1R5		12EP6	
	1R5		12EQ6	
	1R5		12ER6	
	1R5		12ES6	
	1R5		12ET6	
	1R5		12EU6	
	1R5		12EV6	
	1R5		12EW6	
	1R5		12EX6	
	1R5		12EY6	
	1R5		12EZ6	
	1R5		12FA6	
	1R5		12FB6	
	1R5		12FC6	
	1R5		12FD6	
	1R5		12FE6	
	1R5		12FF6	
	1R5		12FG6	
	1R5		12FH6	
	1R5		12FI6	
	1R5		12FJ6	
	1R5		12FK6	
	1R5		12FL6	
	1R5		12FM6	
	1R5		12FN6	
	1R5		12FO6	
	1R5		12FP6	
	1R5		12FQ6	
	1R5		12FR6	
	1R5		12FS6	
	1R5		12FT6	
	1R5		12FU6	
	1R5		12FV6	
	1R5		12FW6	
	1R5		12FX6	
	1R5		12FY6	
	1R5		12FZ6	
	1R5		12GA6	
	1R5		12GB6	
	1R5		12GC6	
	1R5		12GD6	
	1R5		12GE6	
	1R5		12GF6	
	1R5		12GG6	
	1R5		12GH6	
	1R5		12GI6	
	1R5		12GJ6	
	1R5		12GK6	
	1R5		12GL6	
	1R5		12GM6	
	1R5		12GN6	

All three are...

favorites



RMS

TV PREAMPLIFIER SP-4

Provides average gain of 4 to 6 times over entire television range — actually rejects a high percentage of outside interference. Has individually shielded input, output and power sections; complete unit shielded against outside and TV receiver interference.

RMS

LIGHTNING ARRESTOR LA-1

Takes twin lead or coaxial cable. No wire stripping on 300 ohm. No input loss.

RMS all channel

VERSACONE

2 antennas in 1! By simply shifting the rods in the versatile preassembled insulator and reflector plate, conical arrangements of 6 front, 2 back or 4 front and 4 back can be made in seconds!

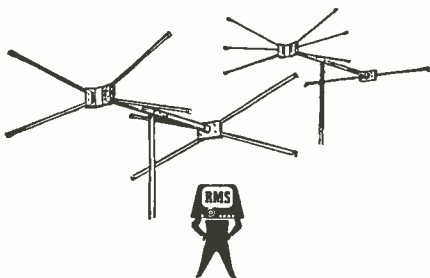

RADIO MERCHANDISE SALES, INC.  
1165 Southern Boulevard, New York 59

MINERVA TROPIC MASTER

A Tropic Master model W-117 was dead with only 25 volts being delivered by the B-supply. All filters and bypass capacitors checked perfect. A check showed no electrical contact between a .01- $\mu$ f coupling capacitor and a grid of one of the 50L6 output tubes. The soldered joints looked perfect; but, when a hot iron was applied, we found that the joint had crystallized and was insulated from the socket pin by a wax-like substance. All other joints were checked and also found to be crystallized — a condition probably caused by the use of wartime solder of low tin content.

The entire underside of the chassis had been sprayed with a waxlike substance in the tropicalization process. Evidently, when the set warmed up, the wax melted and seeped into the pores of the soldered joint and completely isolated some components from the electrical circuit. All joints were cleaned and resoldered to restore the set to normal operation.

PHILCO LP PICKUPS

Low output from Philco LP pickups can be caused by the cartridge's not being properly seated in its holder. Make sure that the old cartridge is firm in its holder before replacing it with a new one.—C. R. Lutz

DIFFICULT I.F. ALIGNMENT

If you cannot peak the i.f.'s in some of the new inverted-chassis models, look for wax around the trimmers on the i.f. transformers. This trouble usually occurs in small, poorly ventilated sets. The wax melts and runs down into the trimmers, making it impossible to align the set. Replace the transformers with wax-free units to avoid a repeat of this difficulty.—Alan McFarlane

ZENITH 12-A-58

This model motorboated loudly when operating on the high end of the broadcast band or on shortwave. Comparing its circuit with those of later models, we found that the oscillator anode (pin No. 6 of the 6A8) was fed through an 11,000-ohm resistor in the set we had while 20,000 ohms was used in later models. Replacing the anode load resistor with 20,000 ohms cleared up the trouble.

When the volume was advanced above a certain level, the power amplifier tubes drew more current and lowered operating voltages throughout the set. This slight drop in voltage was sufficient to detune the oscillator and tune out high-frequency stations. With the oscillator detuned, the signal to the power amplifiers dropped off, they drew less current, voltages returned to normal, and the cycle began anew.—Baron von Huene

PHILCO 48-250

Oscillation in the i.f. amplifier of this and similar models can often be cured by placing a .05- $\mu$ f capacitor between B-plus and the chassis to decouple the i.f. stage from the power supply.—E. R. Crowder

MICROWAVE

Receiver Front End, complete, C/O Dual 723AB Klystron, mounted, TR-ATR Duplexer Section, 2 Stage 30 MC. Pre-amplifier, new, with all tubes ..... \$59.50

TEST EQUIPMENT

- CG-176-AP Directional coupler K Band, 20 DB nominal, type "N" take off, choke to choke, silver-plated ..... \$17.50
  - X Band 1 3/4"x3/4" absorption type wavemeter, micrometer head, 5000 to 8500 mc, Demornay-Buick, #358 ..... 185.00
  - C Band "T" gold-plated at ..... 97.00
  - C Band Flap attenuator Demornay-Buick type #339, gold-plated ..... 100.00
  - X Band 1 3/4"x3/4" Klystron mount with tunable termination, gold-plated ..... 75.00
  - X Band 1 3/4"x3/4" low power load, gold-plated ..... 45.00
  - X Band 1 1/2"x1/2" waveguide to type "N" adaptor, gold-plated ..... 22.50
  - X Band 1 1/2"x1/2" "T" Section, gold-plated ..... 55.00
- X BAND**
- Directional coupler, UG-40/U take off, 20 DB, 20 DB, calibrated, Type "N" take off ..... 17.50
  - Broad Band Directional coupler, type "N" take off, choke to cover, 23 DB, calibrated ..... 18.50
  - Directional coupler, APS-31, Type "N" take off, 23 DB ..... 17.50
  - Bi-Directional coupler, type "N" take off ..... 22.50
  - Flexible Section 18" long ..... 12.00
  - Straight Sections 2 1/2 ft. long choke to cover, silver plated ..... 6.50
  - Pressure Test Section with 15 lb. pressurizing nipple ..... 10.00
  - Bulk Head Feed Trough, choke to cover ..... 12.00
  - Mitered Elbow, choke to cover ..... 12.00
  - Right Angle Bend 2 1/2" Radius, choke to cover, 90° Twist, 6" long ..... 7.50
  - 90° Twist, 6" long ..... 7.50
  - 90° Twist, 5" long with pressurizing nipple ..... 7.50
  - 15° Bend 10" choke to cover ..... 4.50
  - 5 ft. Sections UG-39 to UG-40, termination, new ..... 9.50
  - 180° Bend, 26" Choke to cover 2 1/2" radius, SWR Measuring Section 4" long, 2 type "N" probes mounted full wave apart 1 1/4"x3/4" guide ..... 8.50
  - WE attenuator (P/O TS 35) 0 to 20 DB, less card, ball size guide ..... 12.50
  - 90° Bend E Plane 18" ..... 4.00
  - Rotary Joint, choke to choke ..... 10.00
  - Rotary Joint, choke to choke with decoupling ..... 10.00
  - TR-ATR Duplexer Section for 1B24 and 723AB ..... 12.50
  - Wavemeter-Thermistor Mount ..... 6.00
  - 2K25 723 AB Receiver, Local Oscillator Klystron Mount, complete, with Crystal Mount, ris Coupling with Choke Coupling to TR ..... 22.50
  - TR-ATR Duplexer Section for above ..... 8.50
  - 723AB Mixer-Beacon Dual Oscillator Mount with Crystal Holder ..... 12.00
  - 723AB Mixer-Beacon Dual Oscillator Mount Matching Slugs and tunable termination, new Bi-Directional Coupler, type "N" terminator, 20 DB, calibrated, 1 1/4"x3/4" guide ..... 17.50
  - 12" Flexible Section 1 1/4"x3/4" guide ..... 10.00
  - Crystal Mount in Waveguide ..... 17.50
  - 50-3 Echo Box, Transmission type cavity with bellows ..... 28.50
  - 180° Bend with pressurizing nipple ..... 5.00
  - "S" Curve 18" long ..... 5.00
  - "S" Curve 6" long ..... 3.25
  - APS 31 Mixer Section for mounting two K25's, Beacon Reference Cavity, 1B24 TR Tube ..... 42.50
  - Transition 1 1/2" to 1 1/4"x3/4" ..... 8.00
  - Random Lengths of Waveguide 6" to 18" long per ft. ..... 1.00
- SEND FOR FLYER OF RADIO PARTS  
Hoted Concerns Send P.O.  
Send M.O. or C.O.D. Price F.O.B. N.Y.C. Shpg. Charges  
Sent C.O.D. Phone Di. 9-4124
- COMMUNICATIONS EQUIPMENT CO.**  
131 Liberty St., Dept. C-5 New York City 7, N. Y.

Leotone FACTORY SPEAKER REPAIRS SINCE 1927

- SPECIAL!!! STANDARD CRYSTAL PICKUPS...  
Excel. fidelity; plays 10" & 12" records ..... 1.98
- RADIO-AMPLIFIER STEEL CABINETS (made for RCA coin radios). BEAUTIFUL CHROME GRILLE & MIDE TRIM Marine Gray Finish. Dress up any ELECTRONIC TEST or MEDICAL EQPT. 16 1/2"x 9 3/4"x10 1/2". Shpg. wt. 12 lbs. WHILE THEY LAST ..... 1.98
- 110V. AC INDUCTION MOTOR Self-starting. 1750 RPM. Fract. H.P. 2 1/2"x3 1/4"x1". Shpg. wt. 2 lbs. .... 1.39
- G.E. TRANSMITTING SOCKETS 50W. for 211, 872, etc. BRAND NEW ..... 6 for 2.50
- D.P.D.T. TOGGLES (C-H) 20A/125V. Luminous tip bat handle. Spring return. 1 3/4" mtg. .... 3 for 1.00
- G.E. RELAYS (B109P38) 115V. DC, 8000 ohm coil. SPST. 2"x1 3/8"x1 3/8" ..... ea. 69c
- SELENIUM RECTIFIERS FULL WAVE 18V. AC @ 600ma cont. 3/4"x3/4" ..... ea. 98c
- STRETCH THOSE \$\$\$!!! ORDER TODAY LEOTONE'S "JUMBO RADIO PARTS KIT" Your best buy in New & Disassembled Radio & Electronic parts. 17 FULL POUNDS OF RESISTORS, CONDENSERS, COILS, WIRE, SOCKETS, HARDWARE, ETC., ETC. All these (shpg. wt. 21 lbs.) AND MUCH, MUCH MORE ..... 2.95
- POWER RHEOSTAT 25W-350 OHMS With pointer knob, metal housed. Shpg. wt. 3 lbs. A REAL BUY!!! ..... 89c
- 18 FT. WHIP ANTENNA 6 steel screw-in sects. (S49-54). Shpg. wt. 5 lbs. .... 2.49
- HIGH FIDELITY CRYSTAL MICROPHONE Sensitive diaphragm, hi-imped. (1 3/4" O.D., 1/4" deep). Rubber shock-mtd. ... Less housing ..... 98c
- ALUMINUM HOUSING for crystal mike ..... 15c
- TELEGRAPH KEY & 6V. BUZZER (W.E.) Fully adjustable. All mtd. on 1/4" bakelite. Shpg. wt. 2 lbs. .... 1.25
- "ALNICO" MAGNETS—New EXPERIMENTAL KIT of powerful Bar, Block, "U" Ring, etc. Kit of 10 asstd. .... 1.98

- SPECIAL SERVICEMEN'S KITS  
SPEAKER CONES 4" to 12" moulded & free-edge. Less voice coils. Kit of 12 asstd. .... 1.98
  - SPEAKER REPAIR KIT A PROFESSIONAL KIT SAVES TIME & \$\$\$ Contains: 25 asstd. mtg. rings, 10 spacers, 25 voice coil forms, yds. felt strip, 20 rubber parts, leather segments, shims, cement & instructions. ALL FOR ..... 2.49
  - SPECIAL BARGAIN OFFER!!! BOTH CODE & REPAIR KITS for ..... 3.95
- Min. order \$2.00 20% deposit on all COD's  
Full remittance with foreign orders—  
Please add sufficient postage.

**LEOTONE RADIO CO.**  
85 Day Street, New York 7, N. Y.

RADIO-ELECTRONICS for

**ADMIRAL RECORD CHANGERS**

Distorted reproduction from crystal cartridges can often be traced to one of two sources. Crystal deterioration is usually recognized by a reduction in output accompanied by distortion. It can be cured by replacing the cartridge with a fresh one.

Motor noise is a common type of distortion produced when motor vibrations are transferred to the crystal. This is most noticeable on 33 1/3-r.p.m. records. It can sometimes be cured by tightening the motor mounting. If this does not help, replace the motor.—*Service Division of Admiral Corp.*

**ADMIRAL 19A1 TV CHASSIS**

If the picture and sound cut out intermittently, the trouble may be caused by a bad 6J6 oscillator-mixer tube, dirty turret contacts, or cold-soldered joints in the tuner. Any or all of these troubles may occur simultaneously, so check all of them and avoid another service call for the same complaint.—*William Porter*

**TUNABLE HUM IN A.C.-D.C. SETS**

The G-E model GD-62 and most other a.c.-d.c. sets have .01- $\mu$ f molded paper capacitors across the a.c. line to bypass noise and line modulation. A .01- $\mu$ f capacitor is not large enough to stop strong line modulation which produces tunable hum on some stations. Replace this capacitor with a high-grade, 600-volt capacitor of at least .05  $\mu$ f.

As a preventive measure, use the .01- $\mu$ f molded capacitor to replace the coupling capacitor between the plate of the a.f. amplifier and the grid of the power amplifier. The original coupling capacitor is a potential source of trouble in the form of low-resistance leakage, open circuits, and intermittents. A molded capacitor is less likely to fail in this circuit than the original capacitor.—*John T. Bailey*

**TRACKING SUPERHETS**

Some inexpensive sets do not have low-frequency padders or adjustable slugs on the oscillator coil. To improve tracking, construct a wire loop slightly larger than the circumference of the oscillator coil. Place the loop over the coil and ground one side to the chassis. For tracking, vary the inductance of the coil over narrow limits by adjusting the coupling between loop and coil.—*Charles Buscombe*

**MOTOROLA VT-105, VT-107, VK106**

Greater i.f. sensitivity for improved fringe-area reception can be had by replacing the 6BA6 third video i.f. amplifier with a 6AG5. Remove all connections from pin No. 2 of the 6BA6 socket and move the i.f. transformer ground to the ground point on the socket of the second i.f. amplifier. Bypass the cathode resistor with a .001- $\mu$ f ceramic capacitor. Install a 6AG5 and realign T7 and T8 to complete the job.—*Edward G. Tanrath*

MAY, 1950

**ATLAS "Multi-Cellular" TWEETER**



Model HR-2

**SIX CELL, WIDE ANGLE DISTRIBUTION: 100° x 50°**  
Clean and efficient to 15,000 cycles  
25 watts of program material above 1000 cycles

"Alnico-V-Plus" super efficient magnetic circuit. Heavy die cast sectoral horn, flush mounting 6 3/4" wide, 3 1/2" high, 8" deep. A new high in realism—smooth and clean musical brilliance. Perfect articulation and Sibilance in voice reproduction.

Variable High Pass Filter  
Model FN-1



WRITE FOR COMPLETE DESCRIPTIVE CATALOGUE

**ATLAS SOUND CORPORATION**  
1443 39th St. Bkn. 18, N. Y.

**TUBES TESTED GUARANTEED**

10BP4.....\$14.95 12 LP4.....\$18.95

Selenium Rectifiers:  
75 Ma.....49 100 Ma.....59 200 Ma.....79

Crystal Cartridges; L-70 L-75 MLP1-.....\$1.25

16" Wired 630 chassis with C. R. Tube.....\$189.95

Send for Bargain Flyer

**Bergen Radio & Television Co.**  
345 Bergen St., Newark, N. J.

**SWEDGAL declares a Buyer's DIVIDEND!**

GET THIS PLASTIC PILLOW FREE! Folds to match book size, blows up easily as a balloon (deflates as quickly), sturdy, waterproof, no metal parts, anti-allergic. For home, office, shop, ballgames, beach, picnics, etc. Has 100's of uses! GET YOURS FREE—for every \$5 order. A \$10 order brings 2 Plastic Pillows FREE, etc. You'll want one for every member of your family.

**TUBES** Guaranteed! Brand New Individual Cartons

24¢	6AR5	6V6	35/51	14B6
6C4	6AT6	6V5GT	35B5	14Q7
12A6	688	6V6	35Z5	25Z5
	6BA6	6W4		
	6BE6	6X5		58¢
34¢	6C5	6Y6G	71A	024
6X4	6C6	7A4/XXL	75	6BG6G
36	6D6	7B6	76	50L6
79	6F6	7C6	77	VR150
	6H6	7H7	78	
	6J5	12BA6	85	
38¢	6J6	12BE6	117Z3	69¢
1R5	6K5	12J5	1625	6AC7
155	6K6	12K7	2051	117L7/M7
174	6SA7	12SA7		117Z6
1U4	6SH7	12SC7		
1U5	6SJ7	12SN7	49¢	
5Y3	6SK7	12SQ7	0A4G	89¢
5Y4G	6SL7	24A	1A5	6L6
6AG5	6SN7	25L6	1A7	6US/6G5
6AL5	6SQ7	26	5Z3	25A7GT
6AL7	6SS7	27	5Z4	50A5

TO SPEED DELIVERY! Order Now! Minimum, \$2.50. For C.O.D. shipments enclose 25% deposit. Include adequate postage, excess will be returned. All prices F.O.B. New York, N. Y. WRITE FOR FREE CIRCULAR!

**SPEAKERS** All made this year... brand new... fresh magnets... specially low priced... guaranteed quality!

All Alnico V

4" P.M.—.68 oz.	.....	\$.89	Asst. \$ .85 ea.
4" P.M.—1 oz.	.....	1.05	.95 ea.
4" x 6" P.M.—1 oz.	.....	1.49	.95 ea.
5" P.M.—.68 oz.	.....	.89	.85 ea.
5" P.M.—1 oz.	.....	.95	.85 ea.
6" P.M.—1.47 oz.	.....	1.05	.95 ea.
6" P.M.—1 oz.	.....	1.29	1.19 ea.
6" P.M.—1.47 oz.	.....	1.39	1.29 ea.

RCA #209x1 Crystal Pickup.....\$2.95 Complete

**OUTPUT TRANSFORMERS**

10,000 ohms, center tapped to 3.2 ohms voice coil, channel mounting, Push-Pull.....25c ea.

3Q5 Output.....34c ea. 50L6 Output.....34c ea.

50L6 Push-Pull Output 38c ea. 6V6 Output 38c ea.

6V6 Push-Pull Output.....49c ea.

6V6 PUSH-PULL, RATED 15 WATTS. Secondary taps are 4, 8, 15, 250 and 500 ohms. Fully shielded.....89c ea.

**VOLUME** Standard Brands! With switch & long shaft. CONTROLS 100,000 ohms • 250,000 ohms • 350,000 ohms • 500,000 ohms • 1 megohm.....34c ea.

Any asst. of 10, Only \$3.00

**SPECIAL BUY!** 100,000 ohms, 1 1/2" shaft.....9c ea.

**SWEDGAL RADIO, INC.**  
96 Warren St., Dept. E-3 New York 7, N. Y. Cortlandt 7-6753

**TECH-MASTER Blue Ribbon TELEVISION KIT featuring A G C**  
(Keyed automatic gain control)

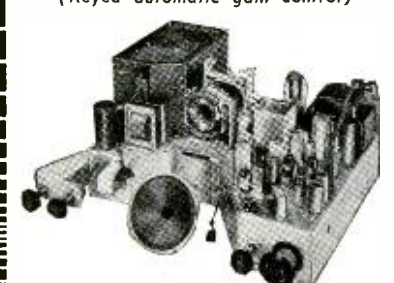

for 10" or 12" KINESCOPIES

Four-stage video IF—4Mc band width. Completely assembled... ready to wire. Factory tested parts of finest make. Trouble-free wiring diagrams permit wiring in a week-end.

Complete with all tubes, less Kinescope **\$119.95**

At your distributor, or write Dept. RE-5 for literature

**TECH-MASTER PRODUCTS CO.**  
443-445 Broadway, New York 13, N. Y.

More leading engineers and technicians have built Tech-Master for their own use than any other Television Kit.

**\$10,000 REWARD**

Warn the government bonus by locating radium with a **P.R.I. GEIGER COUNTER**

The most sensitive portable Geiger Counters made.

Weight only 2 lbs. Battery lasts a year. Prospecting book included free. Priced from \$49.50 complete.

**PRECISION RADIATION INSTRUMENTS, INC.**  
5478-R Wilshire Blvd. Los Angeles 36, Calif.  
Dealer Inquiries Invited

**CHELSEA Spotlight VALUE****LATEST LIC. RCA  
19" CHASSIS**

COMPLETE with Picture Tube

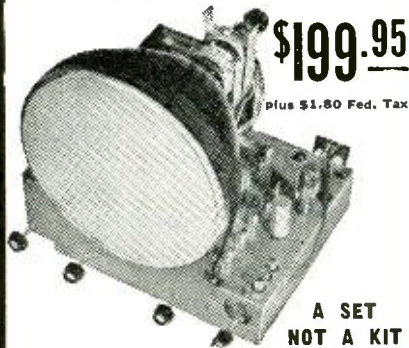
**A SET  
NOT A KIT****JUST PLUG IT IN—IT WORKS!**

A price-shattering offer of our superior C-4 Receiver, completely wired, factory-engineered, aligned and tested. Quality controlled all the way, with improved AGC and AFC, and Standard Coil Front End down to 45 microvolts. RMA Guarantee.

Same Chassis for 16" operation.  
Complete with Picture Tube \$159.50.  
plus \$1.80 Fed. Tax.

Send certified check or money order for \$25 as deposit . . . balance COD, FOB, N.Y. Write or call Dept. A for literature and prices.

The House of Bargains

**CHELSEA TELEVISION  
CENTER, INC.**

Dept. 807, 130 W. 42nd St., N. Y. 18  
Tel: LOnacre 5-2254-5-6

Prices subject to change without notice.

Watch for the  
**NEW**  
Sensational  
**WORKSHOP**  
**TV**  
**ANTENNA**  
All Channel  
Low Price

**DE FOREST GETS CREDIT**

Dear Editor:

In Part X of "Fundamentals of Radio Servicing" (page 50 of the December, 1949, issue) the author talks about "the early engineers" inserting a grid in the diode and inventing the triode. As was pointed out in the January, 1947, de Forest anniversary number of your own magazine, the inventor of the three-element tube was Dr. Lee de Forest. Dr. de Forest was by no means an ordinary "engineer" and he certainly was not plural. I would like to be sure that the newcomers Mr. Frye's articles are designed to reach do not go away with the idea that a basic, world-changing invention like the triode just "grew." It was the product of Lee de Forest, the father of modern radio.

T. JON GIBBS

Long View, Wash.

(The editors and Mr. Frye are equally red in the face, all the more so as we published the article referred to by our correspondent, in which the development of the triode audion was traced step by step. We of all people should know that the triode is not a diode with an extra element inserted in it, as was commonly claimed during the days of the Fleming-de Forest patent suits. Strange as it may now seem, the triode is more closely related to the coherer than to the Fleming valve, as was proved by the January, 1947, article.—*Editor*)

**A CONSTRUCTOR REPORTS**

Dear Editor:

About four years ago I built the Omnicheker described in your July, 1945, issue, and a year later I constructed the Transigenerator detailed in the July, 1946, issue. I tested the resistors for the checker on a radio-school bridge and redesigned the generator somewhat to include a cathode-follower stage.

Mr. Altomare, author of both the articles, might be interested to know that both instruments are still in daily use.

WILFRED J. LENNOX

Warton, Ont.

**RADIO-COOLED HOUSE?**

Dear Editor:

Here is the queerest service problem I have had in my whole career. A customer called me with the complaint that every time he used his radio, the house would get cold within an hour. (He didn't heat the house with electricity, but steam!)

What he didn't tell me was that he had a thermostat-regulated oil burner. I found the thermostat right behind the radio, which was placed in a corner. Moving the radio cooled the thermostat down and permitted the house to heat up.

FERNAND LE PAGE

Montreal, Canada

**OPPORTUNITY AD-LETS**

Advertisements in this section cost 25c a word for each insertion. Name, address and initials must be included at the above rate. Cash should accompany all classified advertisements unless placed by an accredited advertising agency. No advertisement for less than ten words accepted. Ten percent discount six issues, twenty percent for twelve issues. Objectionable or misleading advertisements not accepted. Advertisements for June, 1950, issue, must reach us not later than April 24, 1950.  
Radio-Electronics, 25 W. Broadway, New York 7, N.Y.

**CLEAR VINYL TUBING.** Clear plastic tubing for insulating and protecting wiring (up to 5,000 volts). May also be used for decorative purposes and as fluid hose. Write for complete list of prices and sizes. AMC SUPPLY COMPANY, P. O. Box 1440, Fort Worth, Texas.

**AMATEUR RADIO LICENSES. COMPLETE THEORY** preparation for passing amateur radio examination. Home study courses. American Radio Institute, 101 West 63rd St., New York City. See our ad on Page 110.

**PROJECTION TELEVISION SETS 19" X 25" PICTURE.** UST, used, with AM, FM, Shortwave; Cabinet 69" x 42" x 19", complete \$185.00. Murray Barlowe, 880 59th Street, Brooklyn 20, New York.

**"RAPID RADIO REPAIR"** Just Published. Order now \$1.25 Postpaid or COD. Book reveals new, sure-fire technique, repair any set. Well written . . . wealth of good practical information. . . . says Engineer Weiss, Hickok Co. John D. Burke, 168-08 90th Ave., Jamaica (NY) NY.

**MAGAZINES (BACK DATED)—FOREIGN, DOMESTIC.** arts, Books, booklets, subscriptions, pin-ups, etc. Catalog. 10c (refunded), Ciccone's, 86-22 Northern Blvd., Jackson Heights, N. Y.

**SEEBURG RECORD CHANGER PARTS FOR MODELS** B, K, L. We ship everywhere. Friend's Wholesale Distributors, 106 North Sixth Street, Philadelphia 6, Pa. Dept. RC.

**WE REPAIR ALL TYPES OF ELECTRICAL INSTRUMENTS,** tube checkers and analyzers. Hazleton Instrument Co. (Electric Meter Laboratory), 140 Liberty Street, New York, N. Y. Telephone—Barclay 7-4239.

**HERMAN LEWIS GORDON, REGISTERED PATENT** Attorney, Patent Investigations and Opinions. Warner Building, Washington, D. C.

**BIG MONEY. PART-FULL TIME. RADIO.** Television Electronics. Complete instructions free. R. Johnson, 326B Park Row Building, New York 7, N. Y.

**FREE LISTING STANDARD BRANDS.** Radio Tubes 40% to 60% discount. Parts. Joseph Kase Electronics, 245 Echo Place, Bronx 57, N. Y.

**LANCASTER. ALLWINE & ROMMEL,** 436 BOWEN Building, Washington, D. C. Registered Patent Attorneys. Practice before United States Patent Office. Validity and infringement Investigations and Opinions. Booklet and form "Evidence of Conception" forwarded upon request.

**5D-201 SOLDERING FLUX,** 50c up. Parts Distributor or write LYONART, Trinidad, Colorado.

**RADIOMEN. SERVICEMEN. BEGINNERS — MAKE** more money, easily, quickly. \$2.50 weekly possible. We show you how. Information free. Merit Products, 216-32L 132nd Avenue, Springfield Gardens 13, New York.

**"RADIOBUILDER" FOR EXPERIMENTERS,** 12 Issues \$1.00; 3—25c. Catalog free. Laboratories, 376-B, San Carlos, California.

**SNIPERSCOPE & SNOOPERSCOPIES** wanted. Any condition. Needed immediately. Box #1, Radio-Electronics, 25 W. Broadway, New York 7, N. Y.

**TELEVISION—SHARP AND CLEAR. ADJUST PRESENT** aerial. Build low-cost Precision Antennae. Complete instructions, trouble-shooting chart, diagrams, construction plans, dimensions, no mathematics. Propson's, Lumberton, New Jersey.

Five Element TV Yagi Beams. High Band \$6.75, Low Band \$8.50. Aluminum Tubing, Etc. Willard Radcliff, Postoria, Ohio.

**NEW HYTRON RADIO TUBES, PARTS. BARGAIN SHEET.** Sonoret Radio Co., 36 Woodbury St., Wilkes-Barre, Pa.

*Telrex INC.*  
**CONICAL "V" BEAMS**  
ASBURY PARK, NEW JERSEY

- THE SKILL TO DESIGN
- THE FACILITIES TO PRODUCE
- THE ABILITY TO DELIVER

**MANUFACTURERS OF THE  
CONICAL "V" BEAM  
FOR TV AND FM RECEPTION**

Available through Authorized  
TELREX Distributors

WRITE DEPT. R FOR CATALOG

RADIO-ELECTRONICS for

**RAD!OMAN'S WIFE SPEAKS**

Dear Editor:

I am a technician's wife, not a radio technician. After 12 years of listening to nothing but ham talk and radio and having nothing but radio magazines around, I find your articles on TV most interesting.

In fact, when I have time to read, I find them every bit as interesting as fiction stories because TV is new, growing, and surely here to stay.

My husband thinks about the future just as any service technician should in an area where there is still no TV shown, and now he is one of the best TV service technicians in the city.

MRS. GENEVA B. MINDER

Akron, Ohio

**LIKES NEW INFORMATION**

Dear Editor:

I think you are doing a fine job in giving us the round-robin system of up-to-date technical information. Most of us who are serious about electronics like a "lift" to clear up foggy points, and I have often benefitted by your technotes while at my job.

I don't think you are wasting space at all by printing experimental circuits of Geiger counters, medical tips, etc. It is a good thing to know what's going on in the electronic world, and it's usually the below-average person who refuses to see future possibilities any further ahead than his own not-too-long nose.

CHARLES W. BATES

Washington, D. C.

**HAS COLOR TELEVISION**

Dear Editor:

On Tuesday morning, February 14, we watched the CBS color transmission from 11.15 a.m. to 11.35 a.m. The program consisted of a couple doing the rhumba and models demonstrating color fabrics, flags, and maps in diverse colors.

To watch the transmission in color, we used a 3-inch color disc attached to the end of a 10¢ miniature egg-beater which was turned by hand at a slow speed. The horizontal hold control was set for black-and-white reception which, of course, produced four images on the screen. The vertical hold was adjusted until the pictures stopped rolling vertically. With this arrangement, the color pictures were similar to 16 mm Kodachrome projected on a home screen.

It's surprising how easily color pictures remain in synchronization when using hand power at a slow speed.

MICHAEL L. TORTARIELLO

Newark, N. J.

(While the above device is very interesting and shows what a little ingenuity can do, readers are advised not to bother constructing similar devices, as CBS has discontinued its color transmissions for an indefinite period.—Editor)

MAY, 1950

**A COMPLETE TECHNICAL LIBRARY  
—for the price of just one book!**

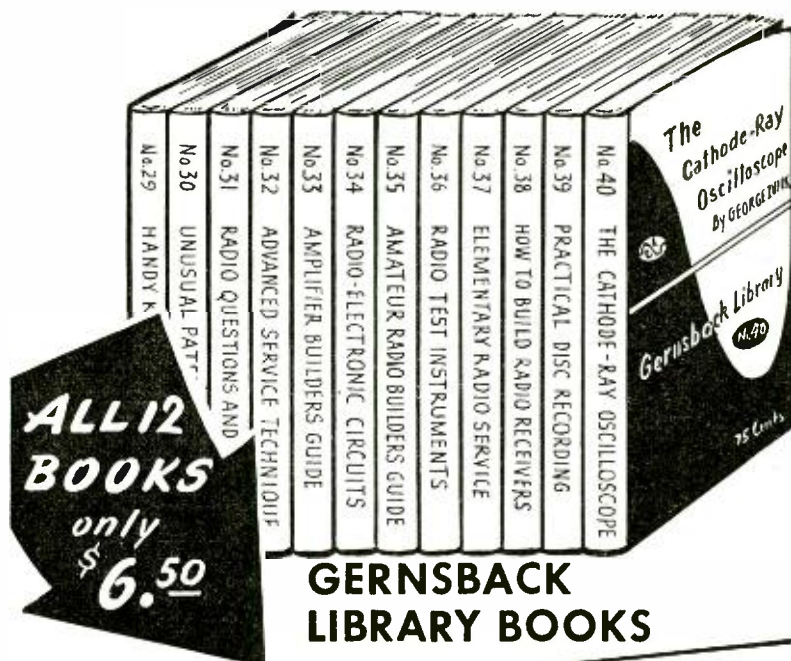

Yes, a whole set of 50¢ and 75¢ books for less than you pay for some texts! The only books of their kind in radio, audio and servicing. They give complete and concise coverage of the field from elementary construction to advanced servicing. Thousands of radio men call them "the best book buy in the industry". Buy the whole set or individual books. See your jobber today. If he can't supply you use the coupon below.

**TEN IMPORTANT 64 PAGE BOOKS - - - ONLY 50¢ EACH**

- No. 29—HANDY KINKS AND SHORT CUTS. A treasury of servicing time savers.
- No. 30—UNUSUAL PATENTED CIRCUITS. A gold mine of useful hook-ups.
- No. 31—RADIO QUESTIONS AND ANSWERS. Helpful answers to frequent questions.
- No. 32—ADVANCED SERVICE TECHNIQUE. A must for advanced service technicians.
- No. 33—AMPLIFIER BUILDERS GUIDE. Designing and building audio equipment.
- No. 34—RADIO-ELECTRONIC CIRCUITS. A compilation of practical circuits.
- No. 35—AMATEUR RADIO BUILDERS GUIDE. For the "ham" who builds his own.
- No. 36—RADIO TEST INSTRUMENTS. Construction of vital test equipment.
- No. 37—ELEMENTARY RADIO SERVICE. How to get started and keep going.
- No. 38—HOW TO BUILD RADIO RECEIVERS. A variety of types for every radio fan.

**TWO BIG BOOKS - - - 75¢ EACH**

- No. 39—PRACTICAL DISC RECORDING. Covers every phase of disc recording; discs, cutters, turntables etc. 96 Pages.
- No. 40—THE CATHODE-RAY OSCILLOSCOPE. How it works and how to use it in servicing TV, FM and AM equipment. 112 Pages.

**RADCRAFT PUBLICATIONS, INC.**

25 West Broadway

New York 7, N. Y.

RADCRAFT PUBLICATIONS, INC. Dept. 50  
25 West Broadway, New York 7, N. Y.

SEE YOUR JOBBER

If he can't supply use coupon.

Enclosed please find \$.....to cover payment of volumes checked.

Name .....	All 12 Books \$6.50			
(Please Print Clearly)	<input type="checkbox"/> 29	50¢	<input type="checkbox"/> 35	50¢
	<input type="checkbox"/> 30	50¢	<input type="checkbox"/> 36	50¢
	<input type="checkbox"/> 31	50¢	<input type="checkbox"/> 37	50¢
Address .....	<input type="checkbox"/> 32	50¢	<input type="checkbox"/> 38	50¢
	<input type="checkbox"/> 33	50¢	<input type="checkbox"/> 39	75¢
City..... Zone..... State.....	<input type="checkbox"/> 34	50¢	<input type="checkbox"/> 40	75¢

# RADIO SCHOOL DIRECTORY

## HAVE YOU A JOB FOR A TRAINED TECHNICIAN?

We have a number of alert young men who have completed intensive training in Radio and Television Repairing. They learned their trades thoroughly by working on actual equipment under personal, expert supervision. If you need a trained man, we invite you to write for an outline of our course, and for a prospectus of the graduate. No fees, of course. Address:

Placement Manager, Dept. P108-5

**COMMERCIAL TRADES INSTITUTE**  
1400 Greenleaf Chicago 26



## RADIO COURSES

Preparatory Mathematics, Service, Broadcast, Television, Marine Operating, Aeronautical, Frequency Modulation, Radar.

Classes now forming for the Summer term June 1st Entrance exam, May 22nd.

*Veterans. Literature.*

**COMMERCIAL RADIO INSTITUTE**  
(Founded 1920)  
38 West Biddle Street, Baltimore 1, Md.

## TV ELECTROMAGNETIC SERVICING COURSE

Practical Shop and Laboratory Training at Largest Resident TV School in the East!

Also RADIO SERVICE & REPAIR, F-M & TELEVISION Preparation for F. C. C. LICENSE EXAMS

★ Approved for Veterans ★

**DELEHANTY SCHOOL of TELEVISION**  
105A EAST 13th STREET • NEW YORK 3, N. Y.

## Make Your Career RADIO and TV

In no other industry does the future hold brighter financial promise and security than in AM and FM Radio, Television. These fields need and want men trained as announcers, script writers, disc jockeys, and radio technicians. It will pay you to investigate the Don Martin School of Radio Arts, established in 1937. Complete day and night classes . . . the latest equipment . . . and a staff of 30 nationally known instructors. Over 97% of the combination men graduates are placed on jobs immediately through the free placement service. Approved for veterans.

FREE—Write for Free Booklet "Your Future in Radio."

**Don Martin School of Radio Arts**  
1655 No. Cherokee, Hollywood, Calif. H Udson 23281

## TELEVISION

PREPARE FOR A GOOD JOB!

COMMERCIAL OPERATOR (CODE) RADIO SERVICEMAN

TELEVISION SERVICING BROADCAST ENGINEER

V. A. Furnishes Books and Tools SEND FOR FREE LITERATURE

**BALTIMORE TECHNICAL INSTITUTE**  
1425 Eutaw Place, Dept. C, Baltimore 17, Md.

# JOBS in TELEVISION

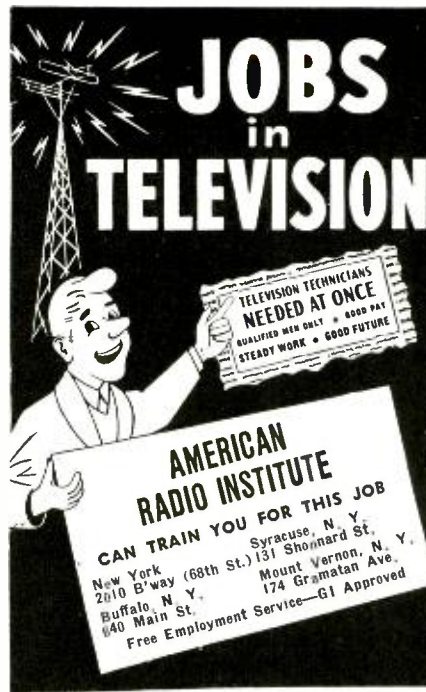

**TELEVISION TECHNICIANS NEEDED AT ONCE**  
QUALIFIED MEN ONLY • GOOD PAY • STEADY WORK • GOOD FUTURE

**AMERICAN RADIO INSTITUTE**  
CAN TRAIN YOU FOR THIS JOB

New York 2010 B'way (68th St.)  
Buffalo N. Y. 640 Main St.  
Syracuse, N. Y. 131 Shomard St.  
Mount Vernon, N. Y. 174 Gramatan Ave.

Free Employment Service—GI Approved

## TELEVISION

Laboratory and theoretical instruction under the guidance of experts, covering all technical phases of Radio, Frequency Modulation and Television. Prepares for opportunities in Broadcasting, Industry or Own Business.

MORNING, AFTERNOON or EVENING SESSIONS. Licensed by N. Y. State. Free Placement Service. APPROVED FOR VETERANS.

ENROLL NOW FOR NEW CLASSES  
Apply Daily 9-9; Sat. 9-2  
VISIT, WRITE or PHONE

## RADIO-TELEVISION INSTITUTE

Pioneers in Television Training Since 1938  
480 Lexington Ave., N. Y. 17 (46th St.)  
PLaza 9-5665 2 blocks from Grand Central



## RADIO ENGINEERING

FM—Television—Broadcast

Police Radio, Marine Radio, Radio Servicing, Aviation Radio and Ultra High mobile applications. Thorough training in all branches of Radio and Electronics. Modern laboratories and equipment. Old established school. Ample housing facilities. 7 acre campus. Small classes, enrollments limited. Our graduates are in demand. Write for catalog.

Approved for Veterans

**VALPARAISO TECHNICAL INSTITUTE**  
Dept. C VALPARAISO, INDIANA

Career Training in a Minimum of Time

## RADIO ELECTRONICS TELEVISION ENGINEERING

Graduates of CREI residence school are preferred by industry because of their training and ability. 23 years practical experience. CREI offers an outstanding faculty, modern laboratories, shops and equipment. New students accepted twice monthly and each may advance as rapidly as he is capable.

Approved for Veterans' Training. Write for Details and Free Catalog.

**Capitol Radio Engineering Institute, Dept. 3058**  
16th & Park Road, N.W., Washington 10, D. C.

Please send me your residence school catalog and details.

Name..... Age.....  
Street.....  
City..... Zone..... State.....

If in high school, what term?  
 I am entitled to train- Send information on ing under GI Bill.  Home Study Courses.

## Become an Electrical Engineer

*B. S. Degree in 36 Months*

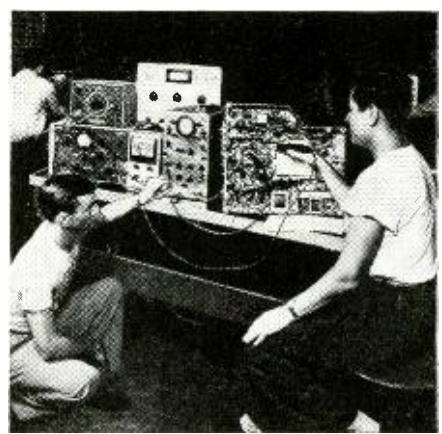

### MAJOR IN ELECTRONICS

Important advantages are yours at this non-profit Technical Institute and College. A valuable year is saved by gaining your B.S. degree in 36 months of continuous study. You get both practical, specialized training in well-equipped laboratories—and a solid education in Electrical Engineering and related arts.

The program includes 19 technical specialty courses in Engineering Electronics, along with four courses in Electronic Design—plus Chemistry, Physics, Mathematics, Economics and basic Electrical Engineering subjects.

You Become an ELECTRONIC TECHNICIAN after 12 months study in the Electrical Engineering course. Electronics is of tremendous growing importance in communications, broadcasting, radio-television, power-system control, high frequency heating, printing and other fields.

The Radio-Television Technician's certificate can be yours in 18 months. You are then equipped for specific positions in receiver and transmitter testing, servicing, sales and production. This course will be credited toward your B.S. degree in Electrical Engineering.

Military, Academic or Practical Training is evaluated for advanced credit. Preparatory courses are also available.

Faculty of 85 specialists. 1555 currently enrolled from 48 states and 23 foreign countries. Over 35,000 alumni. Terms open July, Oct., Jan., April.

## MILWAUKEE SCHOOL of ENGINEERING

Founded 1903 by Oscar Werwath

Write for free 110-page catalog and 48-page pictorial booklet, "Your Career".



**MILWAUKEE SCHOOL OF ENGINEERING**  
Dept. RE-550  
1020 N. Broadway, Milwaukee, Wis.

Without obligation, send me the 110-page catalog and 48-page "Your Career" booklet.

I am interested in \_\_\_\_\_ course.

NAME..... AGE.....  
ADDRESS.....  
CITY..... ZONE..... STATE.....

Check if World War II Veteran

**AUDIO (SOUND) ENGINEERING HOME STUDY TRAINING**

Practical, easy-to-understand lessons, written by competent Audio Engineers and Educators, prepare you for a better job and a good future in the Television, Radio, Motion Picture, and Recording Industries.

Write today for details—Learn while you earn!!

**HOLLYWOOD TECHNICAL INSTITUTE**

Div. HE  
4923 Santa Monica Blvd. Hollywood 27, California

**SHORT CUT** **CODE SPEED**  
Be an Expert

Learn to be a Telegraph or Radio Operator. Thousands of men needed. Intensely interesting work—good pay. Learn at home or wherever you are, quickly, easily, with the famous Candler Code Speed System. Qualify for amateur or commercial license. Book of Particulars Free.

**CANDLER SYSTEM CO.**  
Dept. 3-E, Box 928 Denver 1, Colo.

**TRAIN FOR ALL TYPES FCC (RADIO OPERATOR) LICENSES**

Complete Raytheon AM and FM broadcast transmitters and studio control equipment. Also TV camera chain unit. 30th anniversary year. Please send for catalog R.

**MASS. RADIO SCHOOL**  
271 Huntington Ave., Boston 15, Mass.  
Lic. by Comm. Mass. Dept. Bd.

**ELECTRICAL TRAINING**

Intensive 32 weeks' residence course in fundamentals of industrial electrical engineering, including radio, electronics. Prepares for technician, engineering aides. Approved for veteran training. 57th year. Enter Sept. 5. Catalog.

**BLISS ELECTRICAL SCHOOL**  
7545 TAKOMA AVENUE WASHINGTON 12, D. C.

**RADIO COURSES**

- RADIO OPERATING • CODE
- RADIO SERVICING • ELECTRONICS
- F.M. TELEVISION
- REFRIGERATION SERVICING

Write for Catalog TE and Picture Brochure

**YMACA TRADE & TECH. SCHOOL** 229 W. 46 St., N. Y. 23 ENdicator 2-8117

**RCA RADIO and TELEVISION**

Thorough Training in All Technical Phases

APPROVED FOR VETERANS

DAYS—EVENINGS WEEKLY RATES

FREE PLACEMENT SERVICE FOR GRADUATES

For Free Catalog Write Dept. RC-50

**RCA INSTITUTES, Inc.**  
A Service of Radio Corporation of America  
350 WEST 4TH STREET NEW YORK 14, N. Y.

**AUDIO ENGINEERING SCHOOL**

Practical engineering training in Audio fundamentals. Disc. Film, Magnetic Recording, and Audio frequency measurements.

Studio training simulates Broadcast, Motion Picture, Television, and Commercial Recording work.

Approved for Veterans

**HOLLYWOOD SOUND INSTITUTE, Inc.**  
1040-E North Kenmore, Hollywood 27, Calif.  
Correspondence Courses Available  
Specify if Veteran or Non-Veteran

**RADIO ENGINEERING!**

Complete Radio Engineering course incl. Telev., U.H.F., and F.M. B.S. Degree Courses also in Civil, Elect., Mech., Chem., and Aero. Eng.; Bus. Adm., Acct. Visit campus, see well equipped labs. Low cost. PreP. courses. Personalized instruction. Grads successful. Founded 1884. Enter June, Sept., Jan., March. Write for Catalog.

**DEGREE IN 27 MONTHS**

**TRI-STATE COLLEGE** 2450 College Ave. ANGOLA INDIANA

MAY, 1950

**RADIO OPERATING QUESTIONS AND ANSWERS**, tenth edition, by J. L. Hornung. Published by McGraw-Hill Book Co., Inc., New York. 5 x 8 inches, 588 pages. Price 5.00.

This new edition has been prepared to cover the new questions recently released by the FCC for the radiotelegraph and radiotelephone operators' license examinations. The new questions have been revised and expanded both in theory and practice and many mathematical problems have been included.

A new feature of this text is a special problem section of 45 questions and answers of more advanced problems in general theory, radar, and loran.

**FOUNDATIONS OF MODERN PHYSICS** (second edition), by T. B. Brown. Published by John Wiley & Sons, Inc., N. Y. 6 x 9 1/4 inches. 318 pages plus index. Price \$5.00.

Written in clear, easy-to-understand language, this book contains no higher mathematics, although equations are given where helpful. The author fully discusses wave mechanics, relativity, quantum and kinetic theories, radioactivity, nuclear physics, and other topics. Numerous diagrams and photographs illustrate the experiments.

Each chapter is followed by problems and suggested reading lists. Three appendices are devoted to physical tables and units. Others reveal interesting facts dealing with relativity and radioactivity. This is an excellent text to supplement older books on physics.

—I.Q.

**TELEVISION TUBE LOCATION GUIDE**. Published by Howard W. Sams & Co., Inc. 5 1/2 x 8 1/2 inches. 96 (un-numbered) pages, 219 diagrams. Price \$1.50.

Service technicians have been waiting for this handbook which gives television receiver tube complement layout charts. The charts give the type and function of the tubes, so that often repairs on a set can be made in a matter of minutes if a tube is at fault by referring to the proper chart and replacing the tube.



Ah! Here's your trouble, grid leak

**It's AUTO RADIO PROFIT Time**  
Custom Auto Radios for Popular Cars

Radiomen! Here's your chance to make large extra profits with practically no work! Get in touch with the local Ford, Plymouth, Dodge and Chevrolet automobile dealers, tell them that you can supply Custom Built radios to fit and match perfectly the 1949 and 1950 models of these cars for about half the price that is usually charged! Simple installation—no holes to drill. Specifications: Powerful 6 tube superheterodyne. Has 3 gang condenser with extra stage of RF for out-of-town reception. When ordering specify Ford, Plymouth, Dodge or Chevrolet. List Price \$42.95.



Your cost \$34.97

**6 TUBE AUTO SET**

Auto radio works well in any car. Designed to fit under the dash, mounts with only three bolts to dashboard and bulkhead. Using dual-purpose tubes in a 5-tube superhet circuit, it gives the equivalent of 7-tube performance. Tube complement includes one 6BE6, one 6BA6, one 6AT6, one 6AQ5, one 6X4 (rectifier). Cabinet dimensions: 10 1/2" x 6 1/4" x 4 1/2".

Complete with 5 tubes only..... **\$23.36**

Similar to above, but has RF Stage with 6 tubes—high sensitivity—price **\$25.87**

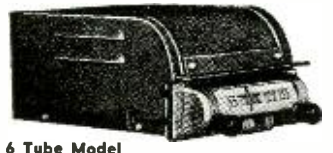

6 Tube Model  
**RADIO DEALERS SUPPLY CO.**  
154 GREENWICH ST. NEW YORK 6, N. Y.

**NEW YORK'S RADIO TUBE EXCHANGE**  
We buy, we sell, we exchange. Write for lists.

**LIBERTY ELECTRONICS, INC.**  
135 LIBERTY STREET NEW YORK 6, N. Y.  
PHONE WORTH 4-8282

**Radio-Television, OR Electricity**  
IN THE GREAT SHOPS OF COYNE

**LEARN**

**COYNE 51st ANNIVERSARY**

**TRAIN QUICKLY!**  
**OLDEST, BEST EQUIPPED SCHOOL of ITS KIND in U.S.**  
**2 Opportunity Fields**

Come to the Great Shops of COYNE in Chicago during our 51st Anniversary Year! Get quick, practical training in RADIO-TELEVISION or ELECTRICITY. G I Approved. Finance plan for non-veterans. Mail Coupon Today for complete details.

**NOT "HOME-STUDY" COURSES!**  
You learn on real, full-size equipment, not by mail. Finest staff of trained instructors to help you get ready quickly for a better job, a fine future.

**FREE BOOKS** Clip coupon for big illustrated Coyne book on either ELECTRICITY or RADIO-TELEVISION. Both books sent FREE if you wish. No obligation; no salesman will call. Act NOW!

**B. W. COOKE, Pres.**  
**COYNE Electrical & Radio-Television School,**  
500 S. Paulina St., Chicago 12, Ill. Dept. 50-81H

Send FREE BOOK and full details on:

RADIO-TELEVISION  ELECTRICITY

NAME.....  
ADDRESS.....  
CITY..... STATE.....

# AMPERITE

## Studio Microphones at P.A. Prices



**Ideal for BROADCASTING RECORDING PUBLIC ADDRESS**

"The ultimate in microphone quality," says Evan Rushing, sound engineer of the Hotel New Yorker.

- Shout right into the new Amperite Microphone—or stand 2 feet away—reproduction is always perfect.
- Not affected by any climatic conditions.
- Guaranteed to withstand severe "knocking around."

Models  
**RBIG—200 ohms**  
**RBHG—Hi-imp.**  
 List \$42.00

"Kontak" Mikes  
 Model SKH, list \$12.00  
 Model KKH, list \$18.00

**Special Offer:** Write for Special Introductory Offer, and 4-page illustrated folder.

**AMPERITE Company, Inc.**  
 561 BROADWAY • NEW YORK 12, N. Y.  
 Canada: Atlas Radio Corp., Ltd., 560 King St. W., Toronto

# Approved TELEVISION FIELD STRENGTH METER

## MODEL A-460

### \$79.50 ONLY



Field Strength Meter; television 12 channel tuner; video IF channel; large 6" directly calibrated meter; hammer-tone finished panel; ideal for locating antenna systems; testing transmission lines; testing efficiency of indoor antennas; checking booster efficiency, etc.

Model A-460 is housed in a heavy gauge steel cabinet, battleship grey finish with 6 tubes (standard brands) IN34 Crystal, operating instructions, circuit diagram and guarantee. Weight 25 lbs. D-8" x H-10" x W-12".

Write for 12-page catalogue.

**APPROVED ELECTRONIC INST., CORP.**  
 142 Liberty St. N.Y.C.

# NEW! AMAZING! FULLY AUTOMATIC METRO ADDING MACHINE

## only \$1995



4 1/2" high, 4 1/2" x 7 1/2" base. Weighs under 5 lbs.

Includes Fed. Exc. Tax

Adds, subtracts, multiplies—works like \$100 machine. Over 30,000 in use. Guaranteed for life.

**WRITE TODAY FOR FREE CIRCULAR**

**METROGRAPH CORP.**  
 2518 Montrose Avenue  
 Dept. 190, Chicago 18, Ill.

# BUY DIRECT From Factory SAVE!!

## New Improved RCA Licensed 16"—630 Chassis \$149.95

Plus \$1.90 Fed. Excise Tax (Less CRT)

**CHECK THESE IMPORTANT FEATURES**

- Completely wired and aligned by expert technicians.
- Newly developed keyed automatic gain control.
- Voltage doubler.
- Wide angle deflection yoke will spread any 16" picture tube.
- Latest type Standard Coil tuner for high sensitivity, UHF adaptation, and easy servicing.
- Full tube complement.

19"—630 Chassis—\$154.95 plus \$1.90 Fed. Excise Tax. (Less CRT)

All glass 16" C-R Tubes.....\$38.90  
 All glass 19" C-R Tubes.....\$73.25  
 No extra charge for rectangular or black tube

Regular RMA Guarantee on all tubes and chassis  
 Beautiful cabinets for above—available

Terms: \$25.00 deposit on all orders—Balance C.O.D.  
 F.O.B.—N. Y. Factory  
 Prices subject to change without notice

**IMMEDIATE DELIVERY** Visit our showrooms

**AD-RITZ MFG. CORP.**

158 Grand Street New York, N. Y. Phone WO 4-6763  
 231 Centre Street New York, N. Y. Phone WO 2-5962

# ODEGAARD ORIGINAL PAINT



for Ribbon or Coaxial Cable

Saves more labor, time and money than any other standoff. No drilling—just quick, easy hammer strokes. Easily drives into wood, mortar, iron, aluminum, etc. Excellent mast-coupler. "Step" latched, permanent installation. Cadmium-plated hardened high-carbon steel nail. Specially punched lo-loss polyethylene.

**SERVICEMEN:** For free sample and nearest distributor's name, write today to Dept. E.

**PARTS DISTRIBUTORS:** Choice protected territories still open. For full details, write today to Dept. E.

**ODEGAARD MFG. CO.**  
 3416 EIGHTH AVE., BROOKLYN 20, N. Y.

### ADVERTISING INDEX

Ace TV Company	105
Ad Ritz Manufacturing Company	112
Aero Towers and Rotator Division	104
Aerovox Corporation	19
Allied Radio Corporation	53, 61
Almo Radio Corporation	89
American Electrical Heater Company	4
American Phenolic Corporation	92
Amperite Company	112
Amplifier Corporation of America	93
Approved Electronics Inst. Corp.	112
Arrow Reconing Company	79
Ashe Radio Company, Walter	105
Astatic Corporation	8
Atlas Sound Company	107
Bell Telephone Laboratories, Inc.	57
Bergen Radio and Tel. Co.	107
Brooks Radio Dist. Corporation	82
Buffalo Radio Supply	91
Capitol Radio Engineering Institute	7
Certified Television Laboratories	113
Channel Master Corp.	13
Chelsea Television Center	108
Cinex Incorporated	113
Circle X Antenna Corporation	80
Cleveland Institute of Radio Electronics	24
Communications Equipment Company	106
Coyne Electrical School	77, 111
DeForest's Training, Inc.	11
Electro Products Laboratories	86
Electro-Technical Industries	64
Electronic Instrument Company, Inc.	67
Electronic Measurements Corporation	104
Esse Radio Company	75
Espey Manufacturing Company, Inc.	93
Fair Radio Sales	81
Feiler Engineering Company	99, 113
General Electronic Dist. Company	58, 59
General Test Equipment Company	99
Gonset Company	78, 100
Greylock Electronic Supply Company	99
Harvard Laboratory	112
Heath Company	14, 15, 16, 17, 18
Hershel Radio Company	73
Hytron Radio & Electronics Corp.	21
Instructograph Company	85
International Resistance Company	70, 71
JFD Manufacturing Company	78, 101
Jackson Electrical Instrument Company	87
Jersey Specialty Company	113
La Pointe-Plascomold Corporation	63
Le-Hi Electrical Company	103
Leotone Radio Corporation	106
Liberty Electronics	111
P. R. Mallory & Company, Inc.	Inside Front Cover
Metrograph Corporation	112
Midway Company	105
J. W. Miller Company	77
Murray Hill Books, Inc.	68
National Company	20
National Radio Institute	3
National Schools	5
Niagara Radio Supply	72
North American Philips Company	22, 23
Oak Ridge Products	74
Odegaard Manufacturing Company	112
Ohmite Manufacturing Company	76
Opportunity Adlets	108
Walter E. Peek, Inc.	90
Precision Apparatus Company	65
Precision Radiation Inst., Inc.	107
Pres-Probe Company	79
Progressive Electronics	80

### Radio School Directory (Pages 110-111)

American Radio Inst.	Hollywood Sound Inst.
Baltimore Tech. Inst.	Hollywood Technical Inst.
Bliss Electrical School	Mass. Radio School
Candler System Co.	Milwaukee School of Engg.
Capitol Radio Engg. Inst.	RCA Institutes
Commercial Radio Inst.	Radio-Television Inst.
Commercial Trades Inst.	Tri-State College
Delehanty Institute	Valparaiso Technical Inst.
Don Martin School	YMCA Trade & Tech. Schools

RCA Victor Division Radio Corporation of America 6, Back Cover

Radio Apparatus Corporation	87
Radio City Products	84, 94
Radio Corporation of America	114
Radio Dealers Supply	100, 111
Radio Merchandise Sales, Inc.	106
Radio Receptor Company, Inc.	97
Radio Supply & Engineering Company	98
Radionic Equipment Corporation	103
Raytheon Manufacturing Company	83
John F. Rider Publisher, Inc.	88
Robin Hood Company	101
Sams & Company, Inc., Howard W.	9, 96, 97
Senco Radio, Inc.	102
Simpson Electric Company	55
Sprague Products Company	66
Sprayberry Academy of Radio	Inside Back Cover
Standard Transformer Corporation	85
Strand Hotel	83
Supreme Inc.	79
Supreme Publications	69
Sutton's Wholesale Electronics, Bill	103
Swedgal Radio, Inc.	107
Sylvania Electric Products	12
Tech-Master Products Company	107
Tel-A-Ray Enterprise	81
Tel-O-Tube Sales Corp.	95
Telrex, Incorporated	108
Trio Manufacturing Company	99
Turner Company (The)	89
Ward Products Corp.	85
Wholesale Radio Parts Company, Inc.	105
Workshop Associates, Inc., The	108

# COLOR ON YOUR TELEVISION NOW



Simply attach TELE-COLOR FILTER to front of your set, and enjoy favorite programs in a glorious color tone. Instead of dull black and white. "TELECOLOR" Filter is one of the latest discoveries. Its special formula fluorescent coloring gives brilliant pleasing color tone. Experience new happiness and enjoyment in life-like color depth, reduced glare, and eye strain. Everyone is talking about and waiting for 3 color television costing hundreds of dollars. Now for a small sum you can enjoy new color toning. This filter is guaranteed to work on every make or size of set.

**TELECOLOR FILTER is a wonderful gift to friends or relatives who own sets.**

10 inch tube	— \$3.00
12 1/2 " " "	— \$4.00
16 " " "	— \$6.00

Dept. RE 5

**HARVARD LABORATORY**  
 659 FULTON ST., BROOKLYN 1, N. Y.



**RADIO OPERATOR'S LICENSE Q & A MANUAL**, by Milton Kaufman. Published by John F. Rider Publisher, Inc., New York. 5½ x 8½ inches, 608 pages. Price \$6.00.

This book is not only a text, but a valuable reference for the student and operator. Questions and answers to pass FCC exams are listed in order, and many of the answers are supplemented with a follow-through discussion to present a clear understanding of difficult technical questions.

The first six chapters cover the six elements of the FCC Commercial Radio Operator Examinations. The material is based on the latest study guide and other recent FCC releases and includes such topics as frequency-shift keying, marine radar, and Ioran.

A complete section of the book is devoted to the Amateur Radio License questions and answers, and rules and regulations. Cross references are made to answers and discussions in the Commercial license section.

**VACUUM EQUIPMENT AND TECHNIQUES**, edited by A. Guthrie and R.K. Wakerling. Published by McGraw-Hill Book Co., New York. 6½ x 9½ inches, 264 pages. Price \$2.50.

This book compiles the results of studies and developments in high-vacuum equipment and practice as made by the personnel of the University of California Radiation Laboratory. The opening chapter covers the fundamentals of vacuum practices and the rest of the book is a practical discussion of vacuum systems, gauges, leak detection equipment, and techniques, with many diagrams and circuits. This work will be a useful reference to anyone working with high-vacuum equipment.

**ELECTRON-TUBE CIRCUITS**, by Samuel Seely. Published by McGraw-Hill Book Co., New York. 6½ x 9½ inches, 529 pages. Price \$6.00.

As a new addition to the McGraw-Hill Electrical and Electronic Engineering Series, about half of this vol-

ume is of a radio engineering character, and the rest covers circuits used extensively in radar, television, pulse communication, and general electronic control.

The author presents the various classes of circuits with no attempt to cover all the aspects of any one class, but rather to present an analytical approach to the study of vacuum-tube circuits. A knowledge of calculus is assumed by the author, although much of the book will be of interest to non-engineering readers.

Of particular interest is a chapter on computing circuits which describes methods for electronically performing such mathematical operations as addition, subtraction, multiplication, squaring, etc.

**SOUND REPRODUCTION** by G. A. Briggs. Published by Wharfedale Wireless Works, Bradford, England. (Distributed in the United States by British Industries Corporation, New York, N. Y.) 5½ x 8½ inches, 143 pages. Price \$2.25.

This book contains much valuable information on the home reproduction of sound. Nearly half is devoted to loudspeakers with much concise data on size and shape of cabinets, materials for making baffles and cabinets, frequency ranges, and speaker locations.

The rest of the book is a discussion of recording systems, records, pickups, and other material of interest to audio enthusiasts and technicians.

**KEY AND ANSWERS TO NEW RADIO-TELEGRAPH EXAMINATION QUESTIONS**, compiled, edited, and published by Alexander A. McKenzie, Hackensack, N. J. 5½ x 8½ inches, 62 pages. Price \$1.

This book is a study guide for prospective FCC licensees based on the July, 1948, revision of FCC study material and on mimeographed Supplement No. 4. It includes Element 1, questions 233 through 296 of Element 5, and questions 226 through 295 of Element 6.—R. H. D.

**ELECTRONIC DISTRIBUTORS FROM COAST TO COAST**

We can now serve you with J.S.C. 300 ohm T.V. twin lead transmission wire, like we have been serving about 50% of television wire requirements in the metropolitan areas during the past year.

**Remember** — our prices are right, our quality the highest, our deliveries the fastest.

Write for quantity quotations.

Sold to wholesale distributors only.

**JERSEY SPECIALTY CO.**

Manufacturers of Wire Products

Little Falls, New Jersey

Phone—Little Falls 4-0784-1404-1405

**TELEVISION RECEIVER—\$1.00**

Complete instructions for building your own television receiver. 16 pages—11"x17" of pictures, pictorial diagrams, clarified schematics. 17"x22" complete schematic diagram & chassis layout. Also booklet of alignment instructions, voltage & resistance tables and troubleshooting hints.—All for \$1.00.

**CERTIFIED TELEVISION LABORATORIES**  
Dept. C, 5507-13th Ave., Brooklyn 19, N. Y.

**SAVE MONEY—BUILD YOUR OWN SPEED LIGHT EQUIPMENT**

**FOR PROFESSIONAL AND AMATEUR**

Easy to follow . . . step-by-step instructions  
Write for FREE list of complete Kits and Components

**CINEX, INC.**

Dept. RE-5 165 W. 46th St., N. Y. 19, N. Y.



**EVERY RADIOMAN Can Use These SERVICE HINTS!**

Valuable Manual Yours—FREE!

Every page of "How to Simplify Radio Repairs" is packed with on-the-bench, practical ideas. Contains photos, charts, diagrams—no fluff—no vague theory. In plain every-day language it gives you priceless suggestions—new servicing ideas. You'll use and benefit from the experience of experts. Partial list of contents: How to Localize Trouble; How to Service Amplifiers; How to Test for Distortion; How to Test Audio Circuits; How to Test Speakers; How to Find Faults in Oscillators; How to Test Radio Parts—and it's all yours—FREE! No obligation.



SEND COUPON OR PENNY POSTCARD FOR YOUR FREE COPY TODAY!

FEILER ENGINEERING CO., Dept. 5RCS  
1601 S. Federal St., Chicago 18, Illinois  
Please RUSH my FREE copy of "How to Simplify Radio Repairs."

Name .....

Address .....

City..... Zone... State.....

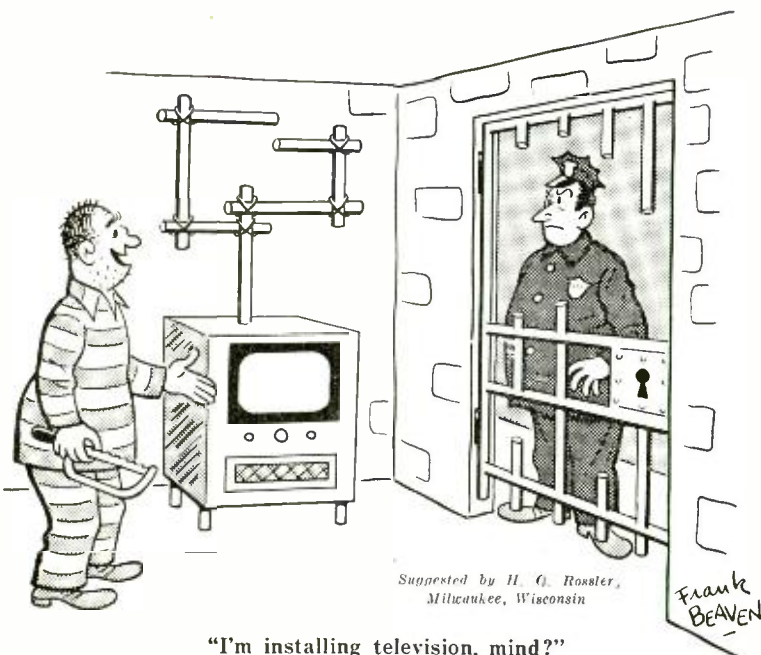

Suggested by H. O. Rossler, Milwaukee, Wisconsin

"I'm installing television, mind?"

# How electronic "paintbrushes" create pictures in our newest art form

There's not a single moving part in a Kinescope —but it gives you pictures in motion

No. 4 in a series outlining high points in television history

*Photos from the historical collection of RCA*

● Ever watch an artist at work—seen how his brush moves over the canvas to place a dot here, a shadow, a line, a mass, or highlight there, until a picture is formed?

Next time you're asked how television pictures are made, remember the paintbrush comparison. But the "brush" is a stationary electron gun, and the "paint" is a highly refined coating of fluorescent material made light or dark in orderly pattern by electrons.

Developed by Dr. V. K. Zworykin, now of RCA Laboratories, the kinescope picture tube is one of the scientific advances which gave us *all-electronic* television . . . instead of the crude, and now outmoded, mechanical techniques.

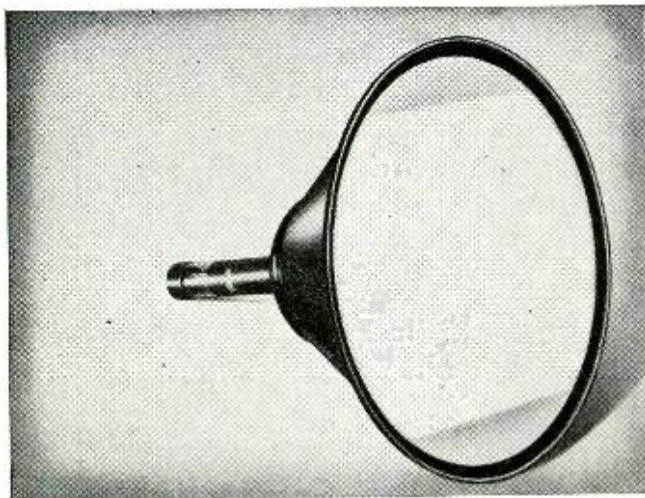

New 16-inch RCA glass-and-metal kinescope picture tube, almost 5 inches shorter than previous types, incorporates a new type of glare-free glass in its faceplate—Filterglass.

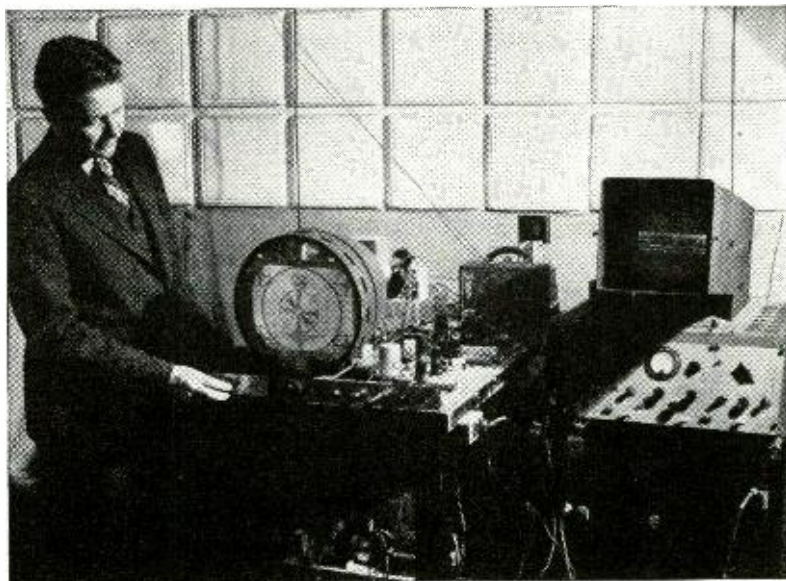

An experimental model of the kinescope—developed by Dr. V. K. Zworykin of RCA Laboratories—is seen undergoing laboratory tests.

Today, through research at RCA Laboratories, these complex kinescope picture tubes are mass-produced at RCA's tube plants in Lancaster, Pa., and Marion, Indiana. Industrial authorities call this operation one of the most breath-taking applications of mass production methods to the job of making a precision instrument.

Thousands of kinescope faceplates must be precisely and evenly coated with a film of absolutely pure fluorescent material . . . the electron gun is perfectly synchronized with the electron beam in the image orthicon tube of RCA television cameras . . . the vacuum produced in each tube must be 10 times more perfect than that in a standard radio tube—or in an electric light bulb!

Once it has been completely assembled, your RCA kinescope picture tube is ready to operate in a home television receiver. In action, an electrically heated surface emits a stream of electrons, and the stream is compressed by finely machined cylinders and pin-holed disks into a pencil-thin beam. Moving back and forth in obedience to a radio signal—faster than the eye can perceive—the beam paints a picture on the face of the kinescope. For each picture, the electron beam must race across the "screen" 525 times. To create the illusion of motion, 30 such pictures are "painted" in every single second.

Yet despite these terrific speeds, there are no moving mechanical parts in an RCA kinescope. You enjoy the newest of our arts because electrons can be made to be obedient.



**Radio Corporation of America**  
WORLD LEADER IN RADIO—FIRST IN TELEVISION



**HERE IS THE LONG SOUGHT ANSWER IN TELEVISION TRAINING FOR THE MAN  
ALREADY IN RADIO! TRAIN AT HOME—FULL PROGRAM—4 TO 8 WEEKS!**

**Low Cost—Monthly Payments. Everything You Need to Learn...**

# TELEVISION

**I Send You NOT JUST an Ordinary TV Kit—But a Complete  
Training System Including TV Test Equipment**

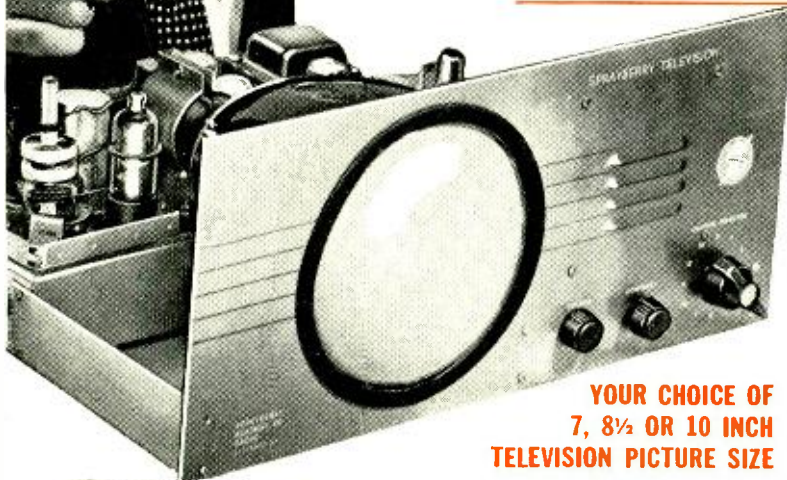

**Here is the NEW Combination Sprayberry  
Television Training System**

Out of my laboratory has come an entirely new Television Training...cutting months off the time required in old methods. I give all the knowledge and experience you need in weeks instead of months. I start where your present radio experience ends. The same day you enroll with me, I rush the first of many big Television kits that I will send during your training. From the first hour you are experimenting and testing practical TV circuits...and you keep right on from one fascinating experiment to another. You build the remarkable new Television Receiver-Tester illustrated at the left and useful TV Test Equipment. I give you theory, too, but it's 100% practical stuff that will make money for you in Television.

**YOUR CHOICE OF  
7, 8½ OR 10 INCH  
TELEVISION PICTURE SIZE**



**Exclusive THREE-UNIT Construction**

You build my Television Receiver-Tester in three separate units—one unit at a time...each complete and self contained within itself. With each unit you perform dozens of important experiments—and each unit may be used in actual Television receiver servicing. In this way my training may save you many dollars by eliminating the need for costly TV Test Equipment. With these three units you can locate most TV Receiver troubles quickly and easily.



**TV Tuner—I.F. Unit**

Contains the RF amplified local oscillator, mixer and three stages of broad band IF amplification and the video second detector. The output constitutes the video signal and audio IF signal. For training, it is used to build and test video second detector, and stagger tuned IF amplifier obtaining 4.5 mc band pass. For TV servicing, it becomes a TV calibrator for IF alignment, substitute tuner, IF signal injector and second detector.

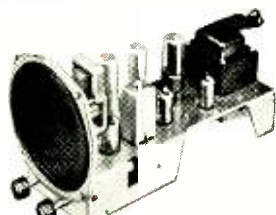

**Video-Audio Amplifier Unit**

Provides 4.5 mc IF ratio detector, low voltage power supply. For TV, it becomes the audio output, including speaker, video output and low voltage power supply for RF and IF stages. For training, it is used to build and test transformer type power supplies, audio, video, IF amplification and FM detection. For TV servicing, it is an audio signal tracer, IF signal tracer, video signal tracer and low voltage power supply.



**Video Tube "Scope" Unit**

Scope unit contains low and high voltage (6000 V.) power supply for independent operation. For television, it becomes the sync, vertical and horizontal sweep circuits and their power supplies. For training, it is used to build and test most TV power supply, deflection, sweep, oscillator, and sync circuits. For TV servicing, it is a video signal tracer and sweep signal analyzer as well as substitute high and low voltage power supplies.

**BE READY FOR TOP PAYING TELEVISION JOBS**

If you are a radio-serviceman, experimenter, amateur or advanced student... **YOUR FUTURE IS IN TELEVISION.** Depending upon where you live, Television is either in your town now... or will be there shortly. This is a vast new industry that needs qualified trained men by the thousand to install and service TV sets. There's really big money in Television, but you **MUST** know what you are doing to "cash-in" on it. I will train you in a few short weeks if you have had previous radio training or experience.

**IMPORTANT—FOR MEN JUST STARTING OUT IN RADIO-TELEVISION**

If you have no previous experience in Radio work, be sure to mark that fact on the coupon below. I will send you complete information about my Radio-Television training that starts with basic fundamentals and carries you right through my new Radio and Television Training. I will send you my two big Radio-Television books, including an actual lesson selected from my course. I want you to know exactly what this great industry has in store for you. There is no obligation, of course, and **NO SALESMAN WILL CALL.**

SPRAYBERRY ACADEMY OF RADIO, Dept. 20-J  
111 North Canal St., Chicago 6, Ill.

Please rush to me all information on your Radio-Television Training plan. I understand this does not obligate me and that no salesman will call upon me.

Name..... Age.....

Address.....

City..... State.....

Please Check Below About Your Experience

Are You Experienced?  No Experience

**VETERANS**—Radio portion of training available under G. I. Bill



**FILL OUT AND MAIL COUPON  
Get these Valuable Books FREE!**

Every Radio Serviceman today realizes his future is in Television. He knows he **MUST** have training—the right kind of practical training such as I am now offering—to protect his job, his business for the future. This is equally important for the man just starting out. And so I urge you to get the facts I offer you **FREE** and without obligation. Learn how quickly and easily you can get into Television. Fill out and mail the coupon **TODAY.**

**SPRAYBERRY ACADEMY OF RADIO, 111 N. Canal, Dept. 20J, Chicago 6, Ill.**

# \$10,000 IN PRIZES

FOR RADIO BATTERY RETAILERS and RCA BATTERY DISTRIBUTOR SALESMEN



## IN THE **RCA BATTERY** "GET THE FACTS" CONTEST

YOU CAN WIN  
A '50 FORD  
... OR OTHER  
VALUABLE  
PRIZES

*FREE ENTRY... here's how*

### LOOK AT THESE DEALER AWARDS! FIRST PRIZE — 1950 FORD SEDAN

Factory equipped 8-cyl. Tudor Custom Sedan

- 2nd Prize \$700 Drexel Bedroom Suite
- 3rd Prize \$619 Drexel Dining Rm. Suite
- 4th Prize \$450 Deep Freeze Unit, 12 Cu. Ft.
- 5th Prize \$350 Rogers Sterling (Service for 12)
- 6th Prize \$260 Kaufmann Travel Luggage (4 matched pcs.)
- 7th Prize \$233 Kroydon Golf Clubs & Bag
- 8th Prize \$145 Kaufmann Travel Luggage (2 matched pcs.)
- 9th to 15th Prizes—\$100 Longines Wrist Watches
- 16th to 25th Prizes—\$25 U. S. Savings Bonds

Duplicate Prizes for  
RCA Battery Distributor Salesmen

Purpose of this contest is to encourage Battery Retailers to Get The Facts on why it's best to stock and sell . . .

*RCA The battery for the Radio Trade!*

Mail coupon today if you DO NOT know the name of your local RCA Battery Distributor.



RCA Battery Sales  
Radio Corporation of America, Harrison, N. J.  
Sirs: I am a Radio Battery Retailer, but DO NOT know the name of my local RCA Battery Distributor.

Please forward this request to him for my FREE copy of the RCA Battery "Get The Facts" Official Contest Booklet containing the FREE Entry Coupon.

Signed \_\_\_\_\_  
Co. Name \_\_\_\_\_  
Street & No. \_\_\_\_\_  
City & State \_\_\_\_\_

No purchases required—no sentences to complete! Simply get your FREE copy of the Official RCA "Get The Facts" Contest Booklet . . . from your nearest RCA Battery Distributor. Then, fill out and mail the Free Entry Coupon in the Contest Booklet to the address printed thereon. Contest closes June 30, 1950. All entries must be postmarked on or before that time.

This contest is open to all radio battery retailers within the continental U. S. A. and to full-time personnel whose duties include the selling of radio batteries.

*Here's how prizes will be awarded*

1. All entry coupons received will be assembled at Contest Headquarters for an impartial drawing to be held July 10, 1950.
2. The retailer whose name appears on the first coupon drawn will be contacted by telephone, person-to-person. He will be asked one of the easy questions about RCA Batteries appearing in the "Get The Facts" Contest Booklet. If this contestant gives the correct answer immediately, he will be awarded first prize.
3. If the contestant fails to give the correct answer immediately, another drawing is held.
4. The above procedure will be followed in awarding all prizes.

**DON'T DELAY.** Get your Contest Booklet from your nearest RCA Battery Distributor. A magnificent prize can be your reward!

Complete Entry and Prize Award Rules can be found in the Official Contest Booklet.

**RADIO BATTERIES**



**RADIO CORPORATION  
of AMERICA**

**HARRISON, N. J.**